

File #:

62-116395

Serial Scope:

547- Bulky

HQ -116

547



62-

HQ-116395

Serial 547

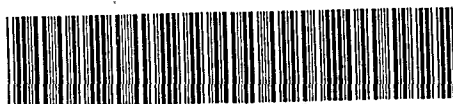

62-HQ-116395-547

BULKY

FF 35 90



RRP004Z75Z

02 HQ-116395-547

FBI - CENTRAL RECORDS CENTER

HQ - HEADQUARTERS

BOX 3590

Class / Case #	Sub	Vol.	Serial #	
0062 116395		1	547	ONLY

2/13/88957



RRP004Z75Z

00-116395-547

8/5/75 Request

IV - A - 2

UNITED STATES GOVERNMENT

Memorandum

- 1 - Mr. Sullivan
- 1 - Mr. Mohr
- 1 - Mr. Callahan

- Tolson _____
- Sullivan _____
- Mohr _____
- Bishop _____
- Brennan C.D. _____
- Callahan _____
- Casper _____
- Conrad _____
- Felt _____
- Gale _____
- Rosen _____
- Tavel _____
- Walters _____
- Soyars _____
- Tele. Room _____
- Holmes _____
- Gandy _____

TO : Mr. W. C. Sullivan

DATE: 12/11/70

FROM : C. D. Brennan

SECRET

- 1 - Mr. C.D. Brennan
- 1 - Mr. Wannall
- 1 - Mr. Day

SUBJECT: EXPANSION OF FOREIGN LIAISON

Foreign General

Pursuant to the Director's instructions, there is attached a letter to Dr. Kissinger informing him of developments in our expansion of our liaison abroad.

We point out that subsequent to his discussion with the Director on 11/10/70, Secretary of State Rogers telephoned the Director 11/20/70 and made arrangements for a meeting of Bureau representatives with Deputy Under Secretary of State William B. Macomber, Jr., on that date. At this meeting the details of the proposed expansion were discussed and confirmed by letter to Mr. Macomber dated 11/23/70. We note that on 12/1/70 State sent a cable to the proposed new posts which advised that our representatives would be maintaining a relationship with the policy (rather than police) agencies in the new countries and asking whether the new offices would present any difficulties. The letter points out that although the Director and Secretary Rogers agreed that no notification would be made to the Central Intelligence Agency (CIA), we were informed, 12/3/70, that Under Secretary of State John N. Irwin II had, in fact, informed CIA.

The letter indicates that State's typographical error resulted in several unfavorable responses but these have been overcome with the exception of intolerable restrictions insisted upon by Ambassador Ellsworth Bunker, Saigon, as result of which we have canceled our request to open there. We also inform Dr. Kissinger of the several instances (Helsinki and San Jose) in which we have agreed to changes in an effort to cooperate. We conclude by naming the new posts being opened and advising that our men will all be in place before Christmas.

ACTION:

Attached for approval is the letter discussed above.

Enclosure

GAD:bsf
(7)

Classified by 6283
Exempt from GDS, Category 3
Date of Declassification Indefinite

SECRET

DEC 14

NATIONAL SECURITY INFORMATION
Unauthorized Disclosure
Subject to Criminal Sanctions

SECRET

Foreign General

December 11, 1970

BY LIAISON

- 1 - Mr. Sullivan
- 1 - Mr. Mohr
- 1 - Mr. Callahan
- 1 - Mr. C.D. Brennan
- 1 - Mr. Wannall
- 1 - Mr. Day

Honorable Henry A. Kissinger
 Assistant to the President
 for National Security Affairs
 The White House
 Washington, D. C.

Dear Dr. Kissinger:

I feel that you should be informed of developments in our expansion of foreign liaison operations which have occurred since our discussion on November 10, 1970.

On November 20, 1970, Secretary of State William P. Rogers telephoned, stating he had discussed our expansion with the President and asking that I send a representative to work out the details with Deputy Under Secretary for Administration William B. Macomber, Jr. Mr. Rogers said he had some reservations concerning Helsinki, Finland, as an FBI liaison post there might be misinterpreted as being in connection with the SALT talks. Mr. Rogers also said he would do nothing about informing the Central Intelligence Agency as he felt that neither State nor FBI should do this in view of the President's participation in the matter, to which I agreed.

FBI representatives discussed the details of our expansion with Mr. Macomber and his staff on the same date and were informed that clearance for my proposals was granted. I confirmed this by letter to Mr. Macomber on November 23, 1970. On December 1, 1970, a Department of State telegram was dispatched to the Ambassadors in the countries where new liaison posts were to be established. This telegram informed the Ambassadors of the approved expansion and asked whether it would present any difficulties.

In a statement of the purpose of the new posts, the telegram said that my representatives would develop and maintain a relationship with policy agencies of the various countries although the Department of State had been informed that this relationship would be with police agencies. Several of the

NATIONAL SECURITY INFORMATION
 Unauthorized Disclosure
 Subject to Criminal Sanctions

- Tolson _____
- Sullivan _____
- Mohr _____
- Bishop _____
- Brennan, C.D. _____
- Callahan _____
- Casper _____
- Conrad _____
- Felt _____
- Gale _____
- Rosen _____
- Tavel _____
- Walters _____
- Soyars _____
- Tele. Room _____
- Holmes _____
- Gandy _____

GAD:mc
 (8)

Classified by 6283
 Exempt from GDS, Category B
 Date of Declassification Indefinite

SEE NOTE PAGE TWO

SECRET

Honorable Henry A. Kissinger

SECRET

Ambassadors, no doubt concerned at this apparent intrusion into their responsibilities, raised questions; and it was necessary for special clarification to be furnished to our Ambassador in Bolivia. Ambassador Ellsworth Bunker, Saigon, South Vietnam, attempted to impose intolerable restrictions with the result that I have canceled my request to open a liaison post there.

I have made every effort to be cooperative with the Department of State in this matter. When it appeared that the post in Helsinki, Finland, created a problem, I suggested Copenhagen, Denmark, as an alternative. Again, when the Ambassador in San Jose, Costa Rica, pointed out the "simply overwhelming" United States presence in that tiny country, I readily agreed to establish our Central American post in Managua, Nicaragua. On December 3, 1970, despite Secretary Rogers' statement concerning notification to the Central Intelligence Agency, I was informed that Under Secretary of State John M. Irwin II had, in fact, discussed our expansion with the Central Intelligence Agency.

In the absence of any additional problems being raised by the Department of State, new liaison posts are being opened in La Paz, Bolivia; Beirut, Lebanon; Caracas, Venezuela; Managua, Nicaragua; Tel Aviv, Israel; and Copenhagen, Denmark. The personnel for these posts have been selected, trained, and all will have arrived at their destinations by December 31, 1970. In addition to the new offices, I have further strengthened our operations by the addition of personnel to existing posts at Paris, France; Bonn, Germany; Buenos Aires, Argentina; and Rome, Italy. A reduction is being made in Mexico City, Mexico, in view of the transfer of the Central American territory, formerly handled from that office, to our post at Managua, Nicaragua.

Sincerely yours,

NOTE:

See memorandum C. D. Brennan to W. C. Sullivan, dated 12/11/70, captioned "Expansion of Foreign Liaison," prepared by GAD:bsf.

- 2 -

SECRET

8/5/75 Request

IV - A - 3

C O P Y

SECRET

10:54 AM

November 20, 1970

MEMORANDUM FOR MR. TOLSON
MR. SULLIVAN
MR. MOHR
MR. BISHOP
MR. C. D. BRENNAN
MR. CALLAHAN

Secretary of State William P. Rogers called. He stated he was calling, after a discussion with the President, about the Bureau's liaison offices abroad, and, of course, he thought it was a good idea and they (the State Department) are enthusiastic about it, but he had just one question which he thought could be handled on the phone due to his busy schedule. He said the only one he had any reservation about is Helsinki, Finland, the reason being, if word gets out, it could appear that it is in connection with the SALT talks or that we are trying to be provocative. He continued that if I thought it will be productive, he thought they were perfectly prepared to take the slight risk that is involved in open discussion about it, but if I thought it is not apt to be productive, he would prefer not to.

I told him I am perfectly willing to postpone it and not have it included in line with the recommendations we have made until after the SALT thing is over and if at that time it is felt desirable to have it there, it can be taken up again. Mr. Rogers suggested then why not go ahead on that basis as to the schedule I have proposed and not make a negative decision on Helsinki but hold it in abeyance as he thought if we could do this and it not get mixed up in SALT talks, it would be a good idea. I said it is a good listening post for information we might obtain, but on the other hand, if it would irritate the SALT talks, I am willing to postpone it.

Mr. Rogers said that was good and we would do that then; that he has spoken to Paul Macomber (William B. Macomber, Jr., Under Secretary for Administration), who is an old-timer and a Republican and sort of an Administrative Assistant, but he is the only one he has spoken to and the only one who knows about it, but he is willing to go ahead and put him in touch with anybody I would like. I told him I would arrange for an Assistant Director to get in touch with him and give the names of the people we want to put in these places so the Ambassadors in turn can be notified.

JEH:edm (10)

NATIONAL SECURITY INFORMATION
Unauthorized Disclosure
Subject to Criminal Sanctions

SECRET

Classified by 6283
Exempt from GDS, Category 3
Date of Declassification Indefinite

~~SECRET~~

November 20, 1970

Memorandum for Messrs. Tolson, Sullivan, Mohr, Bishop, C. C. Brennan, and Callahan

Mr. Rogers commented he thought this was a good development, and I said I thought it would help in getting additional information.

Mr. Rogers asked if Richard Holms, Director, Central Intelligence Agency (CIA), knew about it, and I told him he did not and I did not believe the President was desirous for him to know. I said that in September the President made the suggestion to me as he wanted better intelligence. Mr. Rogers said he, the President, mentioned it to him and it was his idea and nobody else's. I said when the President handed it to H. R. Haldeman he told him to take it up with him, Rogers, and only him, so I assume he did not notify the CIA and certainly we have not. Mr. Rogers said he would not do anything about it and will let the White House do it as he did not think State should or that we should. I said I thought it was up to the President.

Very truly yours,

John Edgar Hoover
Director

SECRET

- 2 -

SECRET

10:54 AM

November 20, 1970

MEMORANDUM FOR MR. TOLSON
MR. SULLIVAN
MR. MOHR
MR. BISHOP
MR. C. D. BRENNAN
MR. CALLAHAN

S/S. ADMINISTRATIVE

Secretary of State William P. Rogers called. He stated he was calling, after a discussion with the President, about the Bureau's liaison offices abroad, and, of course, he thought it was a good idea and they (the State Department) are enthusiastic about it, but he had just one question which he thought could be handled on the phone due to his busy schedule. He said the only one he had any reservation about is Helsinki, Finland, the reason being, if word gets out, it could appear that it is in connection with the SALT talks or that we are trying to be provocative. He continued that if I thought it will be productive, he thought they were perfectly prepared to take the slight risk that is involved in open discussion about it, but if I thought it is not apt to be productive, he would prefer not to.

I told him I am perfectly willing to postpone it and not have it included in line with the recommendations we have made until after the SALT thing is over and if at that time it is felt desirable to have it there, it can be taken up again. Mr. Rogers suggested then why not go ahead on that basis as to the schedule I have proposed and not make a negative decision on Helsinki but hold it in abeyance as he thought if we could do this and it not get mixed up in SALT talks, it would be a good idea. I said it is a good listening post for information we might obtain, but on the other hand, if it would irritate the SALT talks, I am willing to postpone it.

Mr. Rogers said that was good and we would do that then; that he has spoken to Paul Macomber (William B. Macomber, Jr., Under Secretary for Administration), who is an old-timer and a Republican and sort of an Administrative Assistant, but he is the only one he has spoken to and the only one who knows about it, but he is willing to go ahead and put him in touch with anybody I would like. I told him I would arrange for an Assistant Director to get in touch with him and give the names of the people we want to put in these places so the Ambassadors in turn can be notified.

JEH:edm (10)

EX-115

REC-5 15 NOV 25 1970

SECRET
Classified by 60283
Exempt from GDS, Category 3
Date of Declassification Indefinite

NATIONAL SECURITY INFORMATION
Unauthorized Disclosure
Subject to Criminal Sanctions

- Tolson
- Sullivan
- Mohr
- Bishop
- Brennan, C.D.
- Callahan
- Conrad
- Felt
- Gale
- Rosen
- Sullivan
- Tavel
- Trotter
- Tele. Room

364 edm

2 XEROX
NOV 27 1970

UNRECORDED COPY FILED IN 15-37430

SECRET

November 20, 1970

**Memorandum for Messrs. Tolson, Sullivan, Mohr, Bishop, C. D. Brennan,
and Callahan**

Mr. Rogers commented he thought this was a good development,
and I said I thought it would help in getting additional information.

Mr. Rogers asked if Richard Helms^{D.C.}, Director, Central Intelligence Agency (CIA), knew about it, and I told him he did not and I did not believe the President was desirous for him to know. I said that in September the President made the suggestion to me as he wanted better intelligence. Mr. Rogers said he, the President, mentioned it to him and it was his idea and nobody else's. I said when the President handed it to H. R. Haldeman^{D.C.} he told him to take it up with him, Rogers, and only him, so I assume he did not notify the CIA and certainly we have not. Mr. Rogers said he would not do anything about it and will let the White House do it as he did not think State should or that we should. I said I thought it was up to the President.

Very truly yours,

John Edgar Hoover
Director

- 2 -

SECRET

UNITED STATES GOVERNMENT

Memorandum

SECRET

TO : Mr. C. A. Tolson

DATE: 11/20/70

FROM : W. C. Sullivan

SUBJECT: EXPANSION OF FOREIGN LIAISON

Tolson	_____
Sullivan	_____
Mohr	_____
Bishop	_____
Brennan	_____
Callahan	_____
Casper	_____
Conrad	_____
Felt	_____
Gale	_____
Rosen	_____
Tavel	_____
Walters	_____
Soyars	_____
Tele. Room	_____
Holmes	_____
Gandy	_____

Foreign General

Walters

[Handwritten signature]

As instructed, I met this afternoon with Deputy Under Secretary of State for Administration William B. Macomber, Jr. Also present were Deputy Assistant Secretary for Organization and Management, Thomas Stern, Special Assistant J. Stewart Cottman, Jr., Deputy Assistant Secretary for Security, G. Marvin Gentile, and SA Graham Day, who accompanied me. Mr. Macomber and his aides stated that they had been instructed by Secretary Rogers to cooperate with us to the fullest and they indicated they would do everything in their power to assist us. I summarized for them our proposal to add five Agents to presently existing offices and to open six new offices (Beirut, Lebanon; Caracas, Venezuela; La Paz, Bolivia; Saigon, Vietnam; San Jose, Costa Rica; and Tel Aviv, Israel) with a complement of nine Agents. They were aware that we will not assign men to Helsinki, Finland, at this time. Mr. Stern said that he would take care of the necessary establishment of additional positions abroad and Mr. Cottman said that he would immediately inform the interested embassies of the fact that clearance has been granted for the assignment of additional FBI personnel abroad as requested.

It was obvious that if it were not for the approval of the President and Secretary Rogers, clearance would have been extremely difficult, and I detected a slight lack of enthusiasm on the part of Stern and Cottman. Macomber, their superior, was, however, most cordial and cooperative and Gentile has been a strong Bureau supporter for a number of years.

The problem is now definitely in the lap of the Department of State and we will follow this aggressively to be sure no time is lost in opening the new offices.

ACTION:

For information.

WCS:bsf

(6)

- 1 - Mr. Tolson
- 1 - Mr. Sullivan
- 1 - Mr. Mohr
- 1 - Mr. Callahan
- 1 - Mr. C.D. Brennan

*Let. of app
24; 600
12-9-70*

Classified by 0283
Exempt from GDS, Category 13
Date of Declassification Indefinite

COPY SENT TO MR. TOLSON
SECRET

PERS. REC. UNIT

NATIONAL SECURITY INFORMATION
Unauthorized Disclosure
Subject to Criminal Sanctions

[Handwritten signature]

UNITED STATES GOVERNMENT

Memorandum

SECRET

- Tolson _____
- Sullivan _____
- Mohr _____
- Bishop _____
- Brennan, C.D. _____
- Callahan _____
- Casper _____
- Conrad _____
- Felt _____
- Gale _____
- Rosen _____
- Tavel _____
- Walters _____
- Soyars _____
- Tele. Room _____
- Holmes _____
- Gandy _____

TO : Mr. C. D. Brennan *CD*

FROM : W. R. Wannall *WR*

SUBJECT: EXPANSION OF FOREIGN LIAISON

DATE: 11/23/70

As indicated in his memorandum to Mr. Tolson 11-20-70, Mr. Sullivan furnished State the details of our proposal for additional personnel abroad on that date. Mr. Sullivan was informed that the additional overseas positions would be cleared immediately, and State was told that we would proceed to order the transfers.

The Director had approved the opening of an office in Helsinki, Finland, but this is not being done because of the current U. S. - Soviet negotiations. The Helsinki office was recommended as a point from which to handle the Scandinavian countries (Denmark, Sweden, Finland, Norway). This coverage could also be handled from Copenhagen, Denmark, which is on the continent, and would therefore cause no special concern to the Soviets. In fact, Copenhagen would be an ideal site for an office as we already have excellent contacts there and the populace is basically friendly. We believe State would have no objection to this and if we are going to establish a foothold in Scandinavia, now is the time while we have top-level backing.

ACTION:

Attached for approval is a letter to Deputy Under Secretary of State Macomber formally confirming the request made by Mr. Sullivan and adding a request for a new office in Copenhagen, Denmark.

GAD:hc
(7)

Classified by 6283
Exempt from GDS Category 3
Date of Declassification Indefinite

25 DEC 3 1970

Enclosure

- 1-Mr. Sullivan
- 1-Mr. Mohr
- 1-Mr. C. D. Brennan
- 1-Mr. Callahan
- 1-Mr. Wannall
- 1-Mr. Day

SECRET

UNAUTHORIZED DISCLOSURE
Subject to Criminal Sanctions

I approve this reluctantly. It has been most difficult to get the project cleared. I don't want anymore additions nor changes else this whole thing may collapse. H

JAN 16 1971 PERS. REC. UNIT

COPY MADE FOR MR. TOLSON

SECRET

[Handwritten signature]

November 23, 1970

BY COURIER SERVICE

- 1-Mr. Sullivan
- 1-Mr. Mohr
- 1-Mr. C. D. Brennan
- 1-Mr. Callahan
- 1-Mr. Wannall
- 1-Mr. Day

Honorable William B. Macomber, Jr.
 Deputy Under Secretary for Administration
 Department of State
 Washington, D. C.

Dear Mr. Macomber:

Foreign General

Confirming discussion between you and your representatives and Assistant to the Director William C. Sullivan of this Bureau on November 20, 1970, the following is an outline of the proposed increase in FBI personnel overseas:

539 244-300

There are now 28 Agents and 32 clerical personnel assigned to our 11 liaison posts abroad. No change is presently proposed in 7 of these posts. In the 4 remaining we propose change as follows:

Office	Present Complement		Additions		Total
	Agents	Clerks	Agents	Clerks	
Paris	2	2	1	1	6
Bonn	2	3	1	1	7
Rome	1	2	1	0	4
Buenos Aires	1	1	2	2	6

We propose to establish 6 new offices with personnel complements as follows:

Office	Complement		Total
	Agents	Clerks	
Beirut, Lebanon	1	1	2
Caracas, Venezuela	2	2	4
La Paz, Bolivia	1	1	2
Saigon, Vietnam	1	1	2
San Jose, Costa Rica	2	2	4
Tel Aviv, Israel	2	2	4

BY COURIER SVC.
 7 E NOV 24
 COMM-FBI

- Tolson
- Sullivan
- Mohr
- Bishop
- Brennan, C.D.
- Callahan
- Casper
- Conrad
- Felt
- Gale
- Rosen
- Tavel
- Walters
- Soyars
- Tele. Room

GAD:hc
 (8)

[Handwritten signatures and initials]

Classified by 6283 SEE NOTE PAGE TWO.
 Exempt from GDS, Category 3
 Date of Declassification Indefinite

NATIONAL SECURITY INFORMATION
 Unauthorized Disclosure
 Subject to Criminal Sanctions

SECRET

Honorable William B. Macomber, Jr.

There are presently 60 FBI personnel assigned abroad. The above proposal contemplates assignment of 27 additional personnel for a total of 87.

In addition to the offices and personnel outlined above, I propose to open a new office at Copenhagen, Denmark, to be manned by two Special Agents and two clerks. This would be in lieu of the office at Helsinki, Finland, and it would cover the Scandinavian countries as is presently done by personnel stationed in London, England.

Personnel selected for all of the above assignments, with the exception of Copenhagen, are being ordered to report to their new stations promptly. It would be appreciated if you would advise me whether we may proceed to establish a new office at Copenhagen, Denmark.

Sincerely yours,

J. Edgar Hoover

NOTE:

See memorandum W. R. Wannall to Mr. C. D. Brennan 11/23/70 captioned "Expansion of Foreign Liaison," GAD:hc.

SECRET

SECRET

BY COURIER SERVICE

Date: November 27, 1970 1 - Mr. Wannall
 To: Presidential Appointments Staff 1 - Mr. Day
 Department of State 1 - Mr. DeBuck

Attention: Miss Betty L. Groves
 Chief, Title and Rank

From: John Edgar Hoover, Director

Subject: FBI PERSONNEL IN SAIGON, VIETNAM

Mr. Robert B. Hawley, who is currently assigned in the United States, is being designated Legal Attache at the United States Embassy in Saigon, Vietnam.

Mr. Hawley, who was born September 25, 1912, in Japan, has been employed by this Bureau since March 3, 1941. He attended the University of Michigan, Ann Arbor, Michigan, where he received a Bachelor of Arts degree. He also attended Fletcher School of Law and Diplomacy, Medford, Massachusetts, and received a Master of Arts degree. Mr. Hawley will be accompanied by his wife, Bonnie.

The foregoing is furnished for your official use and you may wish to advise the Embassy of the United States in Saigon of the above. It will not be necessary to have anyone meet Mr. Hawley and his wife upon arrival in Saigon.

1 - Foreign Liaison Desk (Detached)

HLD:bsf
 (7)

NOTE:

Mr. Hawley is under transfer to Saigon, Vietnam.

NATIONAL SECURITY INFORMATION

Unauthorized Disclosure
 Subject to Criminal Sanctions

SECRET

Classified by 6283

Exempt from GDS, Category 3

Date of Declassification Indefinite

MAIL ROOM TELETYPE UNIT

BY COURIER SVC.
 31 NOV 30
 COMM-FBI

- Tolson _____
- Sullivan _____
- Mohr _____
- Bishop _____
- Brennan, C.D. _____
- Callahan _____
- Casper _____
- Conrad _____
- Felt _____
- Gale _____
- Rosen _____
- Tavel _____
- Walters _____
- Soyars _____
- Tele. Room _____
- Holmes _____
- Gandy _____

UNITED STATES GOVERNMENT

Memorandum

SECRET

- Tolson _____
- Sullivan _____
- Mohr _____
- Bishop _____
- Brennan, C.D. _____
- Callahan _____
- Casper _____
- Conrad _____
- Felt _____
- Gale _____
- Rosen _____
- Tavel _____
- Walters _____
- Soyars _____
- Tele. Room _____
- Holmes _____
- Gandy _____

TO : Mr. C. D. Brennan *CB*

DATE: 12/8/70

FROM : W. R. Wannall *WRW*

O
Foreign GENERAL

SUBJECT: EXPANSION OF FOREIGN LIAISON

This summarizes the current status of our expansion of our foreign liaison. Following Mr. Sullivan's meeting with Deputy Under Secretary of State Macomber on 11/20/70, State, who had informed us that they would tell the interested embassies that clearance had been granted for assignment of additional FBI personnel abroad, forwarded cablegrams to the affected embassies. One cable went to the four embassies where we are adding to an existing office and another to the embassies where we propose to open new offices, with the exception of Copenhagen, Denmark, which had been the subject of our separate request 11/23/70. Both cables asked the Ambassadors to advise immediately of any difficulties foreseen. Responses from the countries where we now operate were prompt and favorable. Unfortunately, State, in its cable to the new countries referred to our intention to develop and maintain a cooperative relationship with the police and other investigative agencies of the countries covered and made a typographical error. The cable as forwarded indicated that we would be dealing with policy rather than police agencies. Nevertheless, favorable responses were received from most of the addressees. Exceptions were La Paz, Bolivia, and San Jose, Costa Rica.

REC-149

539244-351

La Paz expressed concern over the number of U. S. people there engaged in clandestine operations requiring cover and questioning what Bolivian policy agencies the FBI Agent would or could work with. Marvin Gentile, Deputy Assistant Secretary of State for Security, has advised that State has cabled the Ambassador explaining the typographical error and pointing out that our Legat will not be operating in a clandestine fashion, that he will not be operational, and that his assignment there has been approved at the top level. Gentile says we should proceed to open our office in La Paz without regard to the Ambassador's comments.

GAD:bsf *bsf*
(7)

- 1 - Mr. Sullivan
- 1 - Mr. Mohr
- 1 - Mr. Callahan
- 1 - Mr. C.D. Brennan
- 1 - Mr. Wannall
- 1 - Mr. Day *48*

Handwritten notes:
12/17/70
12/1/70
XEROX
JAN 20 1971

~~DEC 18 1970~~

CONTINUED - OVER

Classified by *6283*
Exempt from GDS, Category *3*
Date of Declassification Indefinite

SECRET

NATIONAL SECURITY INFORMATION
 Unauthorized Disclosure
 Subject to Criminal Sanctions

SECRET

Memorandum to Mr. C. D. Brennan
RE: EXPANSION OF FOREIGN LIAISON

Gentile telephoned 12/8/70 to advise that the U. S. Ambassador in San Jose had described the exceptionally large U. S. presence in this tiny country as "simply overwhelming" and reminded State that it is trying to sharply reduce the U. S. contingent there. The Ambassador recommended that if San Jose was considered essential, our office be limited to one man who would be part of a new "Office of Security" in the Embassy which would serve a number of U. S. agencies. Gentile said that the concept of an FBI office in Central America has definitely been approved but the Ambassador is correct in pointing out that State has insisted on reducing the U. S. delegation in San Jose. Gentile said State is most anxious to assist in establishing an FBI liaison post in Central America and asked whether an office in Managua, Nicaragua, San Salvador, El Salvador, or Panama City, Panama, would permit us to carry out our mission as effectively as an office in San Jose, Costa Rica. From our standpoint, we can do this from any point in Central America. As there is a strongly pro-U. S. government in Nicaragua, the President of which is personally known to SA James A. Miller, who would become Legat there, we could readily open in Managua rather than San Jose. This would require no additional training of personnel or major alteration in our plans. Our intention is to intensify our coverage of the seven Central American countries and this can be handled very effectively from Managua.

With respect to Copenhagen, action has been delayed within State, according to Gentile, because of the recent incident involving the attempted defection of a Lithuanian from a Soviet fishing vessel. The cable informing the Embassy in Copenhagen laid for three days on the desk of Deputy Under Secretary Macomber, who has been testifying before a Congressional committee concerning State's part in that matter. Gentile advised 12/8/70 that Macomber had just approved and signed the cable and that he anticipates no difficulty or delay in the opening of our office in Denmark.

ACTION:

If approved, we will inform State that we will open our office in Managua, Nicaragua, instead of San Jose, Costa Rica, utilizing the same personnel already approved.

Handwritten notes and signatures:
Hand of James A. Miller
Approved to Managua as Legat
Commodore H. Cammerata
Legat perlets 12/16/70
Cable to be handled
Separately per my agency
Robert M. Lang
to Managua
12/17 + etc.
5-10
10/10/70
2 SECRET
* 7

UNITED STATES GOVERNMENT

Memorandum

SECRET

Tolson	_____
Sullivan	_____
Mohr	_____
Bishop	_____
Brennan	_____
Callahan	_____
Casper	_____
Conrad	_____
Felt	_____
Gale	_____
Rosen	_____
Tavel	_____
Walters	_____
Soyars	_____
Tele. Room	_____
Holmes	_____
Gandy	_____

TO : Mr. C. D. Brennan *CD*

DATE: 12/9/70

FROM : W. R. Wannall *WRW*

SUBJECT: EXPANSION OF FOREIGN LIAISON *General*

Hyman
Wannall
Wannall

The attached cable from the U. S. Ambassador at San Jose refers to the establishment of a "four-man FBI office in San Jose." The Director inquired "Why did we ask for four persons to be in San Jose."

The office which we proposed in San Jose would actually be a regional office responsible for all of Central America. We have heretofore covered five countries on a road trip basis from Mexico, but the new office would have included Panama and British Honduras, areas not previously covered but where a number of leads have arisen recently. There is a crying need for quality intelligence relating to this area resulting from the situation in Panama and acts of terrorism and violence in Guatemala. Honduras and El Salvador have recently been at war. Bureau criminal work in Central America has consistently increased in recent years. The full time of one man has been occupied in handling leads in five countries. Addition of a second agent and location of the office within the territory should permit more prompt and thorough handling of our leads as well as the development of the high-level intelligence being sought. To handle the clerical and stenographic work for these two agents, we recommended two clerical employees or a total of four persons for the new office. By separate memorandum, 12/8/70, we recommended that the Central American office be established in Managua, Nicaragua, instead of San Jose because of the "overwhelming" U. S. delegation presently in Costa Rica.

With respect to the comments of U. S. Ambassador Bunker, Saigon, South Vietnam, the Director stated that the Ambassador's requirement is unsatisfactory but typical and instructed that the office be canceled. In this regard the Director is, of course, absolutely right in his comment concerning the high-handed remarks of Bunker. We are aware, however, that part of the difficulty here lies with the State Department cable which notified the embassies where we proposed to open new offices.

Enclosures *sent 12-11-70*
GAD:bsf

- | | |
|------------------|----------------------|
| 1 - Mr. Sullivan | 1 - Mr. Tavel |
| 1 - Mr. Mohr | 1 - Mr. C.D. Brennan |
| 1 - Mr. Callahan | 1 - Mr. Wannall |
| 1 - Mr. Conrad | 1 - Mr. Day |

Classified by *6283*
Exempt from GDS, Category *3*
Date of Declassification Indefinite

CONTINUED - OVER

SECRET

NATIONAL SECURITY INFORMATION
 Unauthorized Disclosure
 Subject to Criminal Sanctions

As discussed in my memorandum 12/8/70, a typographical error in this cable resulted in the Ambassadors being informed that our liaison representatives would develop and maintain a close cooperative relationship with the policy agencies of the countries which they would cover whereas State had been told that we would be developing this relationship with police agencies. It is surprising that more Ambassadors did not protest this apparent intrusion into their personal responsibilities. We have already pointed out this error to State, who acknowledged it and, in fact, State corrected this in a separate cable to La Paz because the Ambassador there had made specific reference to our contact with policy agencies. We feel we should go on written record as well regarding this error.

ACTION:

If approved:

(1) The Administrative Division will promptly cancel the transfers which have been issued to personnel destined for Saigon, South Vietnam (one agent, one clerk).

*Cancl. letters on Robert B. Hawley + Sandra J. Jackson
prepared 12/15/70 jae*

*G.R.
H*

(2) The attached letter will inform the Department of State that we are canceling our proposal to open an office in Saigon and will protest the misstatement of our function in the State cable which was sent to six Ambassadors.

*OSW
H*

*WCS
H*

*G.R.
H*

A

WCS

*WCS
12/13*

PERS. SEC. UNIT

SECRET

J. Edgar Hoover
Walters
Thurman
Walters

December 10, 1970

Foreign General

BY COURIER SERVICE

NATIONAL SECURITY INFORMATION
Unauthorized Disclosure
Subject to Criminal Sanctions

- 1 - Mr. Sullivan
- 1 - Mr. Mohr
- 1 - Mr. Callahan
- 1 - Mr. Conrad
- 1 - Mr. Felt
- 1 - Mr. Tavel
- 1 - Mr. C.D. Brennan
- 1 - Mr. Wannall
- 1 - Mr. Day

Honorable William B. Macomber, Jr.
Deputy Under Secretary for Administration
Department of State
Washington, D. C.

Dear Mr. Macomber:

I have reviewed the various responses forwarded by the United States Ambassadors in the embassies where the FBI proposed to establish new liaison posts and I am disturbed by the apparent misconception regarding the purpose of these posts. It would appear that this misconception arises directly from a typographical error appearing in the Department of State cable number 66641 informing those embassies that FBI liaison representatives are stationed abroad to develop and maintain a close cooperative relationship with the police and other investigative agencies of the countries which they visit. You were informed that such a relationship would be developed with the police and other investigative agencies, which is a quite different function.

539244-347

In view of the comments of the United States Ambassador in Saigon, I am herewith canceling my request to establish a liaison post there.

10 DEC 13 1970

I request that you take the necessary action to insure that the Ambassadors who were misinformed concerning the function of my liaison representatives are properly advised of the true nature of our activities abroad.

Sincerely yours,
J. Edgar Hoover

- Tolson _____
- Sullivan _____
- Mohr _____
- Bishop _____
- Brennan, C.D. _____
- Callahan _____
- Casper _____
- Conrad _____
- Felt _____
- Gale _____
- Rosen _____
- Tavel _____
- Walters _____
- Soyars _____
- Tele. Room _____
- Holmes _____
- Gandy _____

GAD:bsf (11)

~~ENCLOSURE~~

NOTE:

See memorandum W. R. Wannall to C. D. Brennan, dated 12/9/70, captioned "Expansion of Foreign Liaison," prepared by GAD:bsf

Classified by 6283

Exempt from GDS, Category

Date of Declassification Indefinite

SECRET

(21)

SECRET

BY COURIER SERVICE

Date: December 14, 1970

To: Presidential Appointments Staff
Department of State

1 - Mr. Wannall
1 - Mr. Day

Attention: Miss Betty L. Groves
Chief, Title and Rank

From: John Edgar Hoover, Director

Foreign General

Subject: FBI PERSONNEL IN SAIGON, VIETNAM

Reference is made to my letter dated November 27, 1970, and captioned as above which concerned the assignment of Mr. Robert B. Hawley to the United States Embassy at Saigon, Vietnam, as Legal Attache.

Plans to establish a Legal Attache Office in Saigon and to assign Mr. Hawley as Legal Attache have been canceled.

The foregoing is furnished for your official use and you may wish to advise the Embassy of the United States in Saigon of the above.

1 - Foreign Liaison Desk (Detached)

RAB:wmc
(6)

~~TO DEC 15 1970~~

NOTE:

See memorandum Wannall to C.D. Brennan, dated 12/8/70, captioned "Expansion of Foreign Liaison," which concerns cancellation of plans to open an office in Saigon.

539244-332

NATIONAL SECURITY INFORMATION
Unauthorized Disclosure
Subject to Criminal Sanctions

W
bf
Amr
Repro

- Tolson _____
- Sullivan _____
- Mohr _____
- Bishop _____
- Brennan, C.D. _____
- Callahan _____
- Casper _____
- Conrad _____
- Felt _____
- Gale _____
- Rosen _____
- Tavel _____
- Walters _____
- Soyars _____
- Tele. Room _____
- Holmes _____
- Gandy _____

*Cannot be located. Apparently referenced in error. Memorandum referenced is most likely Wannall to Brennan memorandum, 12/9/70, which is furnished.

Classified by 62873
Exempt from GDS Category 3
Date of Declassification Indefinite

BY COURIER SVC.
04 DEC 15
COMM-FBI

SECRET

UNITED STATES GOVERNMENT

Memorandum

TO : Mr. C. D. Brennan *Blow*

FROM : W. R. Wannall *Wannall*

SUBJECT: EXPANSION OF FOREIGN LIAISON

SECRET DATE: 12/17/70

[Handwritten signatures and initials]

- Tolson _____
- Sullivan _____
- Mohr _____
- Bishop _____
- Brennan, C.D. _____
- Callahan _____
- Casper _____
- Conrad _____
- Felt _____
- Gale _____
- Rosen _____
- Tavel _____
- Walters _____
- Soyars _____
- Tele. Room _____
- Holmes _____
- Gandy _____

We have now received State Department clearance for the last of the new liaison posts and are proceeding to establish communications channels so that operations may commence promptly.

State Department Deputy Assistant Secretary for Security Marvin Gentile advised, 12/17/70, that the U. S. Ambassador at Managua, Nicaragua, who had said he would clear the office with Nicaraguan President Somoza, had responded indicating our office had been fully accredited. He asked for details regarding space and services needed and State is informing him that these details will be discussed with him by the Legal Attache. As indicated in cable from Mexico, 12/16/70, new Legal Attache Miller is now in bed under doctor's orders suffering from red measles. He is expected to be released 12/23/70 and will drive to Managua in his personally owned automobile carrying necessary supplies to sustain operations pending receipt of additional supplies from the Bureau.

Prior clearance had already been granted for the other five new offices. The new Legal Attaches will all be in place on or before 12/21/70, except for Legat Miller.

ACTION:

For information. An SAC Letter is being prepared to notify the field of our new foreign liaison coverage.

GAD:bsf
(9)

- 1 - Mr. Sullivan
- 1 - Mr. Mohr
- 1 - Mr. Callahan
- 1 - Mr. Conrad
- 1 - Mr. Tavel
- 1 - Mr. C.D. Brennan
- 1 - Mr. Wannall
- 1 - Mr. Day

SECRET

Classified by 6283
 Exempt from GDS, Category 3
 Date of Declassification Indefinite HS XEROX

SENT DIRECTOR
 12-18-70

JAN 12 1971

NATIONAL SECURITY INFORMATION
 Unauthorized Disclosure
 Subject to Criminal Sanctions

Foreign

General

[Handwritten initials]

539244-232

U-149

95

[Handwritten signature]

[Handwritten initials]

[Handwritten initials]

UNITED STATES GOVERNMENT

SECRET

Memorandum

Tolson	_____
Sullivan	_____
Mohr	_____
Bishop	_____
Brennan, C.D.	_____
Callahan	_____
Casper	_____
Conrad	_____
Felt	_____
Gale	_____
Rosen	_____
Tavel	_____
Walters	_____
Soyars	_____
Tele. Room	_____
Holmes	_____
Gandy	_____

TO : Mr. Callahan

DATE: December 17, 1970

FROM : J. B. Adams

SUBJECT: FOREIGN ASSIGNMENTS
TOURS OF DUTY

W. J. Row
CLARK
CRANFORD
CHERRY

With respect to the establishment of the new Legat post at Managua, Nicaragua, inquiry was made of State Department to determine if this post was considered to be a hardship post. State Department advised that the average State Department officer is assigned there for only two years because of the extreme heat, humidity, and other environmental conditions. The State Department does not request employees to serve more than one tour of duty in Nicaragua. There is also a pay differential of ten percent.

The Director previously approved shortening the tours of duty of other Legat posts which were considered to be hardship assignments (La Paz, Bolivia, and Caracas, Venezuela).

RECOMMENDATION:

That the tour of duty for those employees to be assigned to Managua, Nicaragua, be established at two years.

- 1 - Mr. Clark
- 1 - Mr. Row
- 1 - Movement
- 1 - Special Coordination Unit

TJF:nn
(6)

67-53924

REC-131

6 JAN 20 1971

11 DEC 31 1970

Classified by 6283
Exempt from GDS, Category 3
Date of Declassification Indefinite

1 FEB 8 1971

XEROX
JAN 29 1971

SECRET

REPS. REC. UNIT

NATIONAL SECURITY INFORMATION
Unauthorized Disclosure
Subject to Criminal Sanctions

8/5/75 Request

LII - B

PART I - Section 1

PART II - Section 6, 7A, 7J, 8L

PART I - Section 14F

RETAIN

This document is prepared in response to your request and is not for dissemination outside your Committee. Its use is limited to official proceedings by your Committee and the content may not be disclosed to unauthorized personnel without the express approval of the FBI .

274-10/28

SECTION 1. CONDUCT AND ACTIVITIES OF EMPLOYEES

Regulations concerning the conduct and activities of employees are published in the Code of Federal Regulations (CFR), Title 28, Section 45.735. Their source is found generally in Departmental Order 350-65 dated 12-28-65 which provides that employees shall:

- (1) Conduct themselves in a manner that creates and maintains respect for the Department of Justice and the U. S. Government. In all their activities, personal and official, they should always be mindful of the high standards of behavior expected of them.
- (2) Not give or in any way appear to give favored treatment or advantage to any member of the public, including former employees, who appear before the Department on their own behalf or on behalf of a nongovernmental person.
- (3) Avoid any action which might result in, or create the appearance of--
 - (a) Using public office for private gain
 - (b) Giving preferential treatment to any person
 - (c) Impeding Government efficiency or economy
 - (d) Losing complete independence or impartiality
 - (e) Making a Government decision outside official channels; or
 - (f) Affecting adversely the confidence of the public in the integrity of the Government

Departmental Order 350-65 further provides that an employee shall not have a direct or indirect financial interest that conflicts, or appears to conflict, with his Government duties and responsibilities. Such a conflict exists whenever the performance of the duties of an employee has or appears to have a direct and predictable effect upon a financial interest of such employee or of his spouse, minor child, partner, person, or organization with which he is associated or is negotiating for future employment. A conflict of interest is deemed to exist even though there is no reason to suppose that the employee will in fact resolve the conflict to his own personal advantage rather than to that of the Government. The order also provides that no Department of Justice employee shall participate personally and substantially as a Government employee, through decision, approval, disapproval, recommendation, the rendering of advice, investigation or otherwise, in a judicial or other proceeding, application, request for a ruling or other determination, contract, claim, in which, to his knowledge, he, his spouse, minor child, partner, organization in which he is serving as officer, director, trustee, partner, or employee, or any person or organization with whom he is negotiating or has any arrangement concerning prospective employment, has a financial interest, unless authorized to do so by the Deputy Attorney General. This prohibition includes such financial interests as ownership of securities of corporations or other entities which may become involved in Bureau investigation. The prohibited actions include supervisory decisions and recommendations, as well as investigative activities. Any employee receiving an assignment involving any matters in which he has a direct or indirect financial interest as defined in the departmental order shall immediately advise his superior and shall be relieved of such assignment. Should there be a strong reason for requesting the Department's approval for the employee to participate in the assignment, the matter should be submitted to the Bureau for consideration regarding presentation to the Department. In any event the employee should not participate in such assignment until the Department's authorization has been received. The departmental order specifically exempts from the above prohibition the stock, bond, or policy holdings of an employee in a mutual fund, investment company, bank, or insurance company which owns an interest in an entity involved in the matter provided the fair value of the employee's holding does not exceed one percent of the value of the reported assets of the mutual fund, investment company, or bank.

SECTION 1. CONDUCT AND ACTIVITIES OF EMPLOYEES

In furtherance of the above, the Bureau expects its employees to so comport themselves that their activities both on and off duty will not discredit either themselves or the Bureau. Copies of Departmental Order 350-65 are furnished to employees during their indoctrination on entering the Bureau's service.

Failure by an employee to follow these regulations will result in appropriate disciplinary action including possible dismissal.

A. MISCONDUCT

There are actions the commission or omission of which, considered in light of the Bureau's work and its responsibilities to the American people, is prejudicial to good order and discipline. These are other actions which, either by commission or omission, are contrary to law.

1. Personal Misconduct

Employees should never cause themselves to be mentally or physically unfit for duty. They are not permitted to consume alcoholic beverages during working hours, including that time allotted for meal periods or any period of leave taken if the employee intends to return to work before the termination of working hours. They must not, at any time, engage in criminal, dishonest, immoral or disgraceful conduct or other conduct prejudicial to the Government.

2. Misuse of Government Property

All Government property, automobiles, supplies, equipment, telephones, and facilities are to be used solely for official purposes and are not to be converted to an employee's personal use. In this regard, however, the use of equipment such as cameras for training and practice during nonwork hours shall be considered "official purposes." Any loss, misplacement, theft or destruction of Government property issued to an employee must be reported to his superior immediately.

Special Agents attending school under the Government Employees' Training Act as an official assignment may avail themselves of stenographic and typing facilities in connection with their studies and preparation of assignments provided the request for such assistance is specifically approved in advance by the SAC or the ASAC. This authorization does not extend to employees attending school at their own expense or under Law Enforcement Assistance Administration grants.

Employees are expected to take proper care of any Bureau property issued to them or used by them. No Bureau property, other than that normally associated with maintenance or use of the vehicle, may be left unattended in a personally owned or Bureau automobile under any circumstances even though the outside doors of the car are locked. Personally owned weapons authorized to be carried on official business are to be treated in same manner as Bureau property.

Employees are responsible for complete security of credentials, identification cards and badges at all times. These items must be kept under the employee's control, should be immediately available, are to be displayed for official purposes only and are not to be photographed. The Bureau's name or the initials "FBI" shall not be indiscriminately or improperly used by any employee in either oral or written form. Only ASACs, SACs, Inspectors, Assistant Directors, Assistants to the Director, Associate Director and the Director are permitted to use personal cards for official business as needed. The cards should contain the following: name, official title, Federal Bureau of Investigation. The use thereon of the FBI seal in the upper left corner and the office address and telephone number is optional.

SECTION 1. CONDUCT AND ACTIVITIES OF EMPLOYEES

Agents are also permitted to use such cards; however, their contents are limited to name and office telephone number. Expenses incurred for printing business cards are a personal obligation and are to be handled as such by the employee concerned. Three copies of the current business card utilized by employees are to be forwarded to the Bureau for its records.

Employees are not to make copies for themselves of any reports or correspondence they prepare in the course of their official duties except copies of expense vouchers, Form CA-1 (Employee's notice of injury or occupational disease), nor should they make or maintain possession of copies of official Bureau documents if they have no justifiable need to know the information contained in them. On separation from the Bureau, every employee must return any official documents made or received while in the Bureau's service except for items such as those enumerated above and originals of letters of appointment, commendation, censure or promotion. (See also Bureau rule on disclosure of information set out in Section 1, B, 2, below and regulations set out in Part II, Section 4M, [4m,] of this manual on disclosures of classified information).

3. Illegal Activities

Illegal activities on the part of any employee, in addition to being unlawful, reflect on the integrity of the FBI and betray the trust and confidence placed in it by the American people. Furthermore, unlawful activities can disqualify him for employment by the Government of the United States. It is, therefore, expected that employees will obey not only the letter of the law but the spirit of the law as well whether they be engaged in transactions of a personal or official nature. With respect to investigative activities, this admonition particularly applies to entrapment or the use of any other improper, illegal, or unethical tactics in the procurement of evidence. In this regard, it should be especially noted that, in securing information concerning mail matter, the Bureau will not tolerate a violation of law (Title 18, USC, §§ 1702, 1703, 1708, and 1709). Furthermore, employees must not tamper with, interfere with, or open mail in violation of law nor aid, abet or condone the opening of mail illegally by any employee of the U. S. Postal Service.

As members of a Federal investigative agency, FBI employees must at all times zealously guard and defend the rights and liberties guaranteed to all individuals by the Constitution. Therefore, FBI employees must not engage in any investigative activity which could abridge in any way the rights guaranteed to a citizen of the United States by the Constitution and under no circumstances shall employees of the FBI engage in any conduct which may result in defaming the character, reputation, integrity, or dignity of any citizen or organization of citizens of the United States.

Employees must not install secret telephone systems or microphones without Bureau authority.

No brutality, physical violence, duress or intimidation of individuals by our employees will be countenanced nor will force be used greater than that necessary to effect arrest or for self-defense.

4. Unethical Conduct

a. Membership or Participation

Employees may not act as parole or probation officers. They should refrain from becoming a member, or remaining as a member, of any organization which appropriates funds to defend one of its members charged with a violation of Federal law.

Employees may not serve as officers of any law enforcement organization; however, it is permissible to serve on a committee of such organization.

SECTION 1. CONDUCT AND ACTIVITIES OF EMPLOYEES

Specific prior Bureau authority is necessary in order for an employee to serve as an officer of a civic or other type of organization. Such authority is also necessary before an employee can join an organization where Bureau employment is a prerequisite. It must also be obtained for participation as a judge, sponsor or speaker in any public contest, debate, forum or similar gathering in which the theme of the meeting involves a controversial topic.

[No employee shall serve as range master or as a range officer at a competitive firearms match unless the match is part of a training program in which the FBI is officially participating and the instructor's assignment in the match has been specifically approved by the Bureau in advance.]

In addition, prior Bureau approval is needed for an employee to attend, serve as an instructor, or assist in conducting seminars, classes, or similar gatherings where his FBI affiliation is known with the exception of attendance as a student at a college, law school, school of accounting or other recognized institution of learning. This rule applies to all nonduty time, including leave, and in any case in which a question arises as to the desirability of such participation.

Employees are forbidden to visit trials, hearings or court sessions in any court out of personal curiosity.

b. Gifts and Emoluments

Employees may not accept rewards or gratuities resulting from their FBI employment nor shall they accept fees from an outside source on account of public appearances, speeches, lectures, or publications, if such public appearance or the preparation of the speech, lecture, or publication was part of an employee's official duties. Also, no employee shall receive compensation or anything of monetary value for any consultation, lecture, teaching, discussion, writing, or appearance the subject matter of which is devoted substantially to the responsibilities, programs or operations of the Department, or which draws substantially on official data or ideas which have not become part of the body of public information. Further, in this regard, no employee shall engage, with or without compensation, in teaching, lecturing, or writing that is dependent on information obtained as a result of his Government employment except when that information has been made available to the general public or when the Attorney General gives written authorization for the use of nonpublic information on the basis that such use is in the public interest (see also Item c below).

Bureau officials or other employees who speak or otherwise represent the FBI at conferences, training sessions, banquets, meetings and similar affairs given by outside groups are in official duty status when making such appearances and are entitled to claim payment through the Bureau for travel, subsistence, or other reimbursable expenses incurred. Any payments offered by sponsoring groups to such officials or employees as reimbursement for such expenses should be declined (see also Item c below).

Employees should not solicit contributions from other employees for gifts to official superiors nor may an official superior accept gifts from other employees.

c. Monetary Matters and Financial Dealings

An employee who is an official superior may not borrow money from or give or receive endorsements of promissory notes of other employees working under him or of lesser rank.

SECTION 1. CONDUCT AND ACTIVITIES OF EMPLOYEES

All employees must meet their financial obligations and, in addition, are expected to abide by the laws of the U. S. and of the several states with respect to filing proper tax statements. Any controversy arising with taxing authorities must be brought to the attention of the Bureau immediately. Although employees will not be required to pay unjustified claims, these matters should be resolved with reasonable promptness. In this respect it should be noted that the U. S. Internal Revenue Service may attach salaries of Federal employees who refuse to pay delinquent taxes.

No employee shall use his Government employment (a) for a purpose that is or gives the appearance of being motivated by the desire of private gain for himself or any other person, or (b) to coerce, or give the appearance of coercing, a person to provide a financial benefit to the employee or any other person.

An employee shall not participate in any transaction concerning purchase or sale of corporate stocks or bonds or of commodities for speculative purposes as distinguished from bona fide investment purposes; nor shall any employee use, for the financial gain of himself or another person, or make any other improper use of, whether by direct action on his part or by counsel, recommendation, or suggestion to another person, information which comes to the employee by reason of his status as an employee and which has not become part of the body of public information. Further, no employee shall make investments (a) in enterprises which, it is reasonable to believe, will be involved in decisions to be made by him, (b) on the basis of information which comes to notice as the result of his employee status and which has not become part of the body of public information, or (c) which are reasonably likely to create any conflict in the proper discharge of his official duties.

Employees must have sufficient funds at all times for current travel. No employee shall accept free transportation for official or unofficial purposes when the offer of such transportation might reasonably be interpreted as an attempt to affect his impartiality. He shall not solicit or accept, for himself or any other person, directly or indirectly, any gift, favor, entertainment, loan, or any other thing of monetary value from a person who has or is seeking contractual or other business or financial relations with the Department, is engaged either as a principal or attorney in proceedings before the Department or in court proceedings in which the U. S. is an adverse party, or has interests that may be substantially affected by the performance or nonperformance of his official duties. This prohibition does not, however, prevent: (a) solicitation or acceptance of anything from a friend, parent, spouse, child, or other close relative when the circumstances make it clear that the motivation is a personal or family relationship; (b) acceptance of food and refreshments of nominal value on infrequent occasions in the ordinary course of a luncheon or dinner meeting or other meetings; (c) acceptance of loans from financial institutions on customary terms for normal and ordinary activities such as home mortgage loans; (d) receipt of genuine reimbursement, unless prohibited by law, for actual expenses for travel and such other necessary subsistence for which no Government reimbursement is made and provided the reimbursement is not excessive and employee is not traveling on official business under Bureau orders; (e) acceptance of an award for a meritorious public contribution or achievement.

PART I

SECTION 1. CONDUCT AND ACTIVITIES OF EMPLOYEES

Failure on the part of an employee without good reason and in proper and timely manner to honor debts acknowledged by him to be valid or reduced to judgment by a court or to make or adhere to satisfactory arrangements for settlement thereof may be cause for disciplinary action.

d. Administrative Matters

(1) Present Employees

Recommendations for the promotion of any employee shall come only from the official superior of the employee. This procedure shall be followed, too, concerning any recommendations tending to initiate, retard, or rescind any order or administrative action of the Bureau. Failure to abide by these regulations will result in severe administrative action as well as possible removal from the service.

No employee is to be advised of any pending, contemplated, or recommended personnel action (promotion, reassignment, transfer, commendation, incentive award, disciplinary action, and the like) until action thereon has been taken and he is officially notified. In this regard it should be understood by all employees that the matter of promotions, demotions, transfers, and any other similar official personnel action must be decided solely on the merits of the individual case. The welfare of the Bureau must take precedence over desires and convenience of the employee involved, particularly with respect to transfers of investigative personnel who are expected to be available for service wherever the needs of the Bureau may require their assignment. Any attempt, either directly or indirectly, to bring outside influence to bear on the Bureau to promote, rescind, or alter official actions in any manner is contrary to the above-stated policy.

Employees should not instruct, or be concerned with the instruction, of any person in preparation for examinations of the U. S. Civil Service Commission (per Executive Order dated 10-13-05, as amended 5-7-19).

(2) Former Employees

Under no circumstances should any Special Agent in Charge or other FBI personnel become involved in any matter directly or indirectly concerning a present or former employee who has been arrested or is otherwise in difficulty with a law enforcement agency; nor should any Bureau employee attempt to mitigate the action of any arresting officer, agency, or prosecuting officer, or in any way try to minimize publicity concerning such employee or former employee or incident. Any incidents of this nature regarding present or former employees should be reported immediately to the Bureau.

Employees must not vouch for any person or give testimonials, affidavits, or letters of recommendation for anyone without prior Bureau approval except that SACs or division heads may approve letters of recommendation prepared by employees in their offices

SECTION 1. AUTHORITY - TRAINING - SUBMISSION OF INFORMATION

- (5) Applicants must have the following general qualifications:
- (a) Must be not less than 25, nor more than 50 years of age at time of beginning of session
 - (b) Must have at least a high school diploma or an equivalency certificate
 - (c) Must have at least 5 years of substantially continuous law enforcement experience
 - (d) Must be in excellent physical condition, certified for exertion and regular participation in firearms, physical training, and defensive tactics. Certification must be made as result of physical examination by medical doctor of candidate's choice and at candidate's expense. SF-88 must be submitted as a condition precedent to invitation.
 - (e) Candidate's weight must be within desirable limits for his height and frame (FD-300).
 - (f) Candidate must be of outstanding character and reputation, having demonstrated unimpeachable moral conduct and integrity.
 - (g) Candidate must be career law enforcement officer and agree to remain in law enforcement for a minimum of three years after graduation from the NA.
- c. Listing agencies and applicants for a designated session
- (1) The office indices must be checked, Special Agents who deal directly with the department consulted, and any other additional sources necessary must be checked for information concerning the law enforcement agency recommended for representation at the NA. The communication to the Bureau recommending the agency must show that this check has been made. If there is any information in the office files or otherwise known by the office revealing any difficulty with the agency or unfavorably reporting upon the integrity and efficiency of the agency, this information must be set out in the communication to the Bureau, even though it has been furnished previously.
 - (2) At the time National Academy applications are received by field offices a 1-Dead file should be prepared. When applicant is to be considered for a specific National Academy class, SAC, ASAC, or Field Supervisor will personally, formally interview each applicant. At that time the person conducting the interview should review the National Academy application, verify completeness of candidate's answers and clarify any ambiguities during the interview. Interview form (FD-319) must be completed and submitted to the Bureau, together with application form. Applicant's fingerprints are to be taken and forwarded to Bureau with interview and application forms via FD-456. Appropriate leads to auxiliary offices should be set forth on FD-456. "Authority to Release Information" (FD-406) must be signed by the applicant at the time of his initial interview and should be maintained in the field office file.
 - (3) Deleted
 - (4) National Academy investigations should be instituted no later than 60 days prior to the session for which a candidate is recommended. Unless advised to the contrary by the Bureau, the field office will institute investigation 10 days from the date of the cover letter (FD-456) with a 21-day deadline for submitting completed results by airtel summary. No other communications to the Bureau are required unless investigation is discontinued or for some other express reason.
- d. Cost
- [Incidental personal expenses must be handled by the officer or his department. There is no cost for training or equipment. Room, board, laundry and dry cleaning services are provided to all students without charge. Round trip air coach fare is furnished to qualified municipal, county, and state law enforcement officers from the United States.]

SECTION 1. AUTHORITY - TRAINING - SUBMISSION OF INFORMATION

- e. Length of course
The course is [11] weeks in length.
- f. Rule for attendance
Trainees must attend classes promptly and regularly.
- g. Investigation of applicants
- (1) Ordered by the Bureau
Investigation not to be initiated until applicant meets Bureau weight requirements. These investigations must be conducted with the same degree of care, completeness, and penetrative inquiry as would be afforded an investigation of a Special Agent applicant.
 - (2) All derogatory information must be set out in detail.
 - (3) Deleted
 - (4) Deleted
 - (5) Not less than 90 days prior to commencement of session, SAC is required to specifically recommend and adequately justify .. most worthy agency and candidate whom he desires to have attend. Include results of indices checks on candidate and nominating department.
 - (6) When candidate has been previously completely investigated but has not attended NA for reasons not precluding future attendance, such candidate will not be accepted for attendance if investigation is more than six months old, until investigation is brought up to date. Where investigation is less than six months old but more than 90 days old, field must make current office indices check, credit and arrest checks, and report results specifically in summary letter recommending candidate's appointment. Credit status must be obtained based on FD-406 signed by individual during initial interview.
 - (7) Results of investigation are to be submitted by airtel summary and investigative notes must be maintained in the 1-A Exhibit Envelope in the case file for ready reference purposes.
 - (8) If, during investigation of applicant, matters arise reflecting unfavorably upon law enforcement agency by which he is employed, bring this information to Bureau's attention with specific reference to the NA applicant. Such matters include complaints charging civil rights violations by members of the department, charges of graft or corruption, or uncooperative attitude by executive head or other members of the agency.
- h. Invitations to attend National Academy will be made by letter from Bureau headquarters. SAC and Agents assigned to his office are not to promise an applicant that he will attend a certain session of National Academy. SACs and Agents are to be extremely careful in relations with local authorities in order that no one can infer he will be attending next session.

Upon receipt of a copy of letter of invitation, the SAC must cause an acceptance to be forwarded to Bureau without delay. If delay will occur or for some reason invitation will be declined, SAC shall notify the Bureau immediately furnishing details as to situation.

One week prior to the commencement of each National Academy session, the SAC must forward an airtel to the Bureau, Attention: Training Division, certifying that each of his prospective NA applicants scheduled to attend that session is knowledgeable regarding FBI firearms range safety rules and has a reasonable proficiency with weapons used in our training.

SECTION 1. CONDUCT AND ACTIVITIES OF EMPLOYEES

concerning individuals who are not present or former employees of the FBI. However, employees preparing such letters should state therein that any recommendation is based on the personal knowledge of the writer and should not be construed as an official endorsement or recommendation of the FBI. All other letters should be sent to the Bureau for approval. (See Part I, Section 16, Subsection O, for detailed instructions concerning inquiries, including those from duly accredited investigators.)

e. Investigative Operations

Employees should not conduct joint investigations with other Bureau personnel without official permission; when such joint operation is justified, required (as in certain civil rights cases), or desirable (as, for example, in sensitive or security-type interviews), the appropriate supervisor may give permission for Agents of his squad to work together. If the circumstances require Agents from different squads to work jointly, approval must be obtained from each squad supervisor whose personnel are involved. In a resident agency, such permission must be secured from the senior resident Agent. When employees receive such permission, they should show the joint investigation on their #3 cards and daily reports (when such daily reports are required) by showing the name of the other Agent or Agents and the file number of the case. Approval of #3 cards and daily reports by the supervisors and senior resident Agent shall signify that such permission was granted by them.

An Agent, whether assigned to a resident agency or the field office headquarters city is not to visit his home during official working hours without specific supervisory approval. Any such visit and reasons therefor must be clearly shown on his #3 card and daily report when prepared.

Employees must not participate indiscriminately in matters with local law enforcement officers where no FBI jurisdiction exists. Further, they must tactfully decline to witness signed statements obtained by local law enforcement officers where no FBI jurisdiction is involved. In addition, no one other than persons officially connected with an investigation or whose services are needed, should be permitted to accompany our personnel on an investigation. In this regard, prior [SAC] authority is necessary for members of law enforcement agencies to accompany Agents during the course of security-type investigations.

f. Outside Employment

(1) In addition to Bureau Employment.

Employees shall not engage in other work, employment, occupation, profession, business, or partnership without receiving prior Bureau approval. This rule applies whether the outside employment is self-employment or employment by a third party. No Special Agent is to act as a salesman in the commercial sense. Any case of doubt should be referred to the Bureau for decision (See Part I, Section 16G, of this manual for further details). Furthermore, no employee, even though having Bureau approval to engage in part-time outside employment in a sales capacity, may solicit

SECTION 1. CONDUCT AND ACTIVITIES OF EMPLOYEES

business on Bureau premises at any time, whether during the workday or on his own time before or after working hours or during lunch or rest periods. In no case may Bureau premises be used for storage or display of merchandise.

- (2) Releases to Accept Other Full-time Employment
- Because of the Bureau's need for all satisfactory, trained employees, it is not possible to grant releases to employees desiring to accept employment in another Federal agency. Employees should be invited to discuss any problem in this regard with their supervisor, SAC, or division head. An employee should promptly apprise his supervisor of any plans to seek other employment. If the employee has applied for Federal or other employment, he should be advised that he will not be considered for favorable personnel action such as grade promotion (within-grade increase not affected), while on record as seeking other employment. Advise the Bureau, by letter to the attention of the Administrative Division, of the results of the interview and every 60 days thereafter regarding this matter.

It should be ascertained from the employee if he has taken a Civil Service Test and if he is on the Civil Service Register.

[g. Active Participation in Military Reserve or National Guard Units (Ready Reserve Status)

According to Department of Defense directive 1200.7, heads of Federal agencies should:

- (1) Make determinations identifying key agency positions and key personnel occupying such positions.
- (2) Take the necessary action to assure that agency key employees holding key positions are not permitted to hold conflicting mobilization assignments with military Ready Reserve. If employees are permitted to hold conflicting mobilization assignments, the agency's emergency operating capabilities may be seriously eroded, which is contrary to the purpose and intent of preparedness planning.

Due to the key Federal employee status of Special Agents and certain clerical personnel, a request is made of the appropriate branch of military, when such a position is reached, and when applicable, that the key employee be reassigned from an active or ready reserve to the Standby Reserve, or discharged from Reserve or National Guard obligation. Due to availability requirements of Bureau Special Agents and in order to permit adequate contingency planning in the event of an emergency which might necessitate the mobilization of the Ready Reserve Unit, Bureau policy precludes any Special Agent or other designated key Federal employee from enlisting, reenlisting, or reactivating into an active or Ready Reserve Unit without prior Bureau approval.]

5. Political Activities

In general, Bureau employees are prohibited from engaging in any form of political activity except the right to vote. They should avoid any undertakings which may have any tinge of a political nature or which could be construed to indicate the FBI favors any political party. If any doubt exists, prior Bureau approval must be obtained. No advertisements supporting any candidate for public office or for any unauthorized purpose may be placed on official cars or Government property.

SECTION 1. CONDUCT AND ACTIVITIES OF EMPLOYEES

Under the Subversive Activities Control Act of 1950, it is unlawful for: (a) any member of the Communist Party of the United States of America to hold any nonelective office or employment under the U. S. or, in seeking, accepting, or holding any nonelective office or employment under the U. S., to conceal or fail to disclose the fact that he is a member of such organization; (b) any officer or employee of the U. S. to contribute funds, or services to the Communist Party, USA, or to advise, counsel, or urge any person known to him to be a member of such organization to perform or omit to perform any act if such act or omission would violate any provision of the Subversive Activities Control Act of 1950; (c) any Federal officer or employee to disclose classified security information to an individual he knows or has reason to believe is a member of the Communist Party, USA, is an offense punishable by fine of not more than \$10,000, imprisonment for not more than 10 years, or both. Upon conviction of such offense, the officer or employee becomes thereafter ineligible to hold any office or place of honor, profit or trust created by the Constitution or laws of the U. S. (See also Bureau rule on disclosure of information set out in Section 1, B, 2, below, and regulations set out in Part II, Section 4M, 4Q, of this manual on disclosure of classified security information).

SECTION 6. PUBLICATIONS, PRESS, AND PUBLIC CONTACTS

[A. PRESS POLICY

1. Confidential Nature of FBI Operations

See Part I, Section 1, page 9, paragraph B of Manual of Rules and Regulations.

2. Title 28, Section 50.2 of the Code of Federal Regulations concerning release of information by personnel of the Department of Justice relating to criminal and civil proceedings states:

"(a) General. (1) The availability to news media of information in criminal and civil cases is a matter which has become increasingly a subject of concern in the administration of justice. The purpose of this statement is to formulate specific guidelines for the release of such information by personnel of the Department of Justice.

"(2) While the release of information for the purpose of influencing a trial is, of course, always improper, there are valid reasons for making available to the public information about the administration of the law. The task of striking a fair balance between the protection of individuals accused of crime or involved in civil proceedings with the Government and public understandings of the problems of controlling crime and administering government depends largely on the exercise of sound judgment by those responsible for administering the law and by representatives of the press and other media.

"(3) Inasmuch as the Department of Justice has generally fulfilled its responsibilities with awareness and understanding of the competing needs in this area, this statement, to a considerable extent, reflects and formalizes the standards to which representatives of the Department have adhered in the past. Nonetheless, it will be helpful in ensuring uniformity of practice to set forth the following guidelines for all personnel of the Department of Justice.

"(4) Because of the difficulty and importance of the questions they raise, it is felt that some portions of the matters covered by this statement, such as the authorization to make available Federal conviction records and a description of items seized at the time of arrest, should be the subject of continuing review and consideration by the Department on the basis of experience and suggestions from those within and outside the Department.

"(b) Guidelines to criminal actions. (1) These guidelines shall apply to the release of information to news media from the time a person is the subject of a criminal investigation until any proceeding resulting from such as investigation has been terminated by trial or otherwise.

"(2) At no time shall personnel of the Department of Justice furnish any statement or information for the purpose of influencing the outcome of a defendant's trial, nor shall personnel of the Department furnish any statement or information, which could reasonably be expected to be disseminated by means of public communication, if such a statement or information may reasonably be expected to influence the outcome of a pending or future trial.

"(3) Personnel of the Department of Justice, subject to specific limitations imposed by law or court rule or order, may make public the following information:

SECTION 6. PUBLICATIONS, PRESS, AND PUBLIC CONTACTS

"(i) The defendant's name, age, residence, employment, marital status, and similar background information.

"(ii) The substance or text of the charge, such as a complaint, indictment, or information.

"(iii) The identity of the investigating and/or arresting agency and the length or scope of an investigation.

"(iv) The circumstances immediately surrounding an arrest, including the time and place of arrest, resistance, pursuit, possession and use of weapons, and a description of physical items seized at the time of arrest.

"Disclosures should include only incontrovertible, factual matters, and should not include subjective observations. In addition, where background information or information relating to the circumstances of an arrest or investigation would be highly prejudicial or where the release thereof would serve no law enforcement function, such information should not be made public.

"(4) Personnel of the Department shall not volunteer for publication any information concerning a defendant's prior criminal record, but information drawn from Federal conviction records may be made available in response to a specific request.

"(5) Because of the particular danger of prejudice resulting from statements in the period approaching and during trial, they ought strenuously to be avoided during that period. Any such statement or release shall be made only on the infrequent occasion when circumstances absolutely demand a disclosure of information and shall include only information which is clearly not prejudicial.

"(6) The release of certain types of information generally tends to create dangers of prejudice without serving a significant law enforcement function. Therefore, personnel of the Department should refrain from making available the following:

"(i) Observations about a defendant's character.

"(ii) Statements, admissions, confessions, or alibis attributable to a defendant, or the refusal or failure of the accused to make a statement.

"(iii) Reference to investigative procedures such as fingerprints, polygraph examinations, ballistic tests, or laboratory tests, or to the refusal by the defendant to submit to such tests or examinations.

"(iv) Statements concerning the identity, testimony, or credibility of prospective witnesses.

"(v) Statements concerning evidence or argument in the case, whether or not it is anticipated that such evidence or argument will be used at trial.

"(vi) Any opinion as to the accused's guilt, or the possibility of a plea of guilty to the offense charged, or the possibility of a plea to a lesser offense.

"(7) Personnel of the Department of Justice should take no action to encourage or assist news media in photographing or televising a defendant or accused person being held or transported in Federal custody. Departmental representatives should not make available photographs of a defendant unless a law enforcement function is served thereby.

SECTION 6. PUBLICATIONS, PRESS, AND PUBLIC CONTACTS

"(8) This statement of policy is not intended to restrict the release of information concerning a defendant who is a fugitive from justice.

"(9) Since the purpose of this statement is to set forth generally applicable guidelines, there will, of course, be situations in which it will limit the release of information which would not be prejudicial under the particular circumstances. If a representative of the Department believes that in the interest of the fair administration of justice and the law enforcement process information beyond these guidelines should be released, in a particular case, he shall request the permission of the Attorney General or the Deputy Attorney General to do so.

"(c) Guidelines to civil actions. Personnel of the Department of Justice associated with a civil action shall not during its investigation or litigation make or participate in making an extrajudicial statement, other than a quotation from or reference to public records, which a reasonable person would expect to be disseminated by means of public communication if there is a reasonable likelihood that such dissemination will interfere with a fair trial and which relates to:

"(1) Evidence regarding the occurrence or transaction involved.

"(2) The character, credibility, or criminal records of a party, witness, or prospective witness.

"(3) The performance or results of any examinations or tests or the refusal or failure of a party to submit to such.

"(4) An opinion as to the merits of the claims or defenses of a party, except as required by law or administrative rule.

"(5) Any other matter reasonably likely to interfere with a fair trial of the action."

3. News Releases

Fairness, accuracy, and sensitivity to the rights of defendants, as well as to the public's right to know, must prevail in all dealings with the news media. Favoritism should be shown toward no newsman or no news medium.

Information concerning the FBI, including information regarding arrests and other developments in cases investigated by the FBI, is disclosed to news media, including newspapers, news magazines, news services, and radio and television networks or stations, (a) as news releases or announcements, initiated by the FBI, and (b) as responses to inquiries emanating from newsmen.

Each field office should maintain a control file containing all news releases issued by the office since the last inspection.

a. "One-Office" news releases

The vast majority of news releases made by field offices are issued to announce arrests in FBI cases. The provisions of Section 50.2 clearly apply to all of these. If an SAC feels that an exception to those provisions should be made in any individual case, he should make his views known to the Assistant Directors of (a) the substantive division involved and (b) the External Affairs Division. Exceptions to the instructions provided in Section 50.2 can be approved only by the Attorney General or the Deputy Attorney General, not by any official of the FBI.

SECTION 6. PUBLICATIONS, PRESS, AND PUBLIC CONTACTS

All news releases made by field offices should be issued over the name of the SAC. They should be issued to all interested news media in the field office territory as simultaneously as possible; and they should provide as full an account of the facts as can be disclosed within the provisions of Section 50.2. In news releases announcing arrests or other developments attributable to the joint efforts of the FBI and other law enforcement agencies, appropriate recognition should, of course, be given to those other agencies.

SACs may authorize other experienced Special Agents, including Resident Agents, in their field offices to read or deliver news releases issued over the SAC's name to news media after the SAC has approved those news releases. However, those Special Agents should not expand upon the information in the news releases; and they should answer any inquiry or request for additional information by courteously telling the newsman involved that his inquiry or request will be brought to the attention of the SAC as quickly as possible for his consideration and action. The reason for the policy of referring all such matters to the SAC is to assure both uniformity and accuracy of any supplemental information that is provided to news media.

SACs also may authorize other experienced Special Agents to record news releases in compliance with requests of radio and television stations. However, only SACs or ASACs should make live or filmed television appearances involving the reading of news releases.

SACs have the option of accepting or declining such time-consuming requests made by radio and television stations. If declined, however, the declinations should be tactfully worded and explained so as to avoid any impression of partiality. If a request is accepted, the radio and/or television station involved should understand that the SAC or the Special Agent designated by the SAC will merely read the text of the news release and will not answer questions.

On occasion, SACs also issue news releases or make announcements dealing with administrative matters such as transfers of the SAC or ASAC of the field office or presentation of service awards to personnel of the field office. On such occasions, photographs and biographical sketches of the personnel involved may be made available to the news media. However, requests to interview these employees about their official duties and experiences should tactfully be declined.

SECTION 6. PUBLICATIONS, PRESS, AND PUBLIC CONTACTS

So as to minimize the opportunities for criminal elements to harass Special Agents and their families, neither photographs nor biographical sketches of Special Agents should be made available to news media in connection with news releases, announcements, or inquiries pertaining to FBI investigations. The sole exception is in the case of employees who are killed in line of duty, in which instances the release of photographs and biographical data should be coordinated with the Administrative Division and the External Affairs Division.

b. "Multi-Office" news releases

News releases announcing arrests or other important developments in wide-ranging investigations often require close coordination and simultaneous release to the press by two or more field offices. The External Affairs Division should be consulted before any such news release is made, and consideration should be given to the question of whether a national news release is merited.

c. National news releases

As a general rule, national news releases announcing arrests or other investigative developments are issued only in exceptional cases involving (1) prominent persons, such as well-known business and civic leaders, entertainers, athletes, or officials of local, county, state, or Federal Government; (2) persons of national notoriety, such as members of the "Ten Most Wanted Fugitives"; (3) persons arrested for crimes that have attracted nationwide interest, such as prevailed in the 1950 robbery of Brink's Inc., at Boston, Massachusetts, and the 1964 murder of three young civil rights workers in Neshoba County, Mississippi; and (4) persons whose crimes have international ramifications, such as espionage agents or fugitives who have fled abroad. The heads of headquarters and field divisions should assure that the essential facts of all such cases, including anticipated developments therein, are promptly brought to the attention of the External Affairs Division on a continuing basis.

National news releases generally will be issued in Washington, D. C. However, copies will be furnished to all interested field offices so that the SACs of those offices can make them available to local news media within minutes of their release in Washington.

SACs should not expand upon the contents of national news releases without approval of both the substantive division involved and the External Affairs Division.

SECTION 6. PUBLICATIONS, PRESS, AND PUBLIC CONTACTS

4. News Media Inquiries

There are two categories of news media inquiries. The first involves routine inquiries received at the field office regarding either investigative or administrative matters. These should be answered by the SAC or ASAC within the guidelines indicated above.

In responding to such inquiries, SACs and ASACs should be courteous, factual, and as helpful as possible. They should, however, avoid answering hypothetical questions or questions that would require them to express personal opinions on matters of intense local or national controversy.

The second category involves inquiries from the news media in emergency situations. Often these are received by Special Agents at the scenes of arrests, gun battles, or other fast-moving developments in investigations.

Unless undercover assignments or similar overriding circumstances dictate otherwise, Special Agents who are approached by newsmen at the scenes of fast-moving developments in FBI cases should (a) identify themselves as "a Special Agent of the FBI," (b) furnish the name of the field office to which they are assigned, and (c) state the general nature of the investigative operations, such as "We are here to serve an arrest (or a search) warrant." Requests for additional information should be answered by courteously referring the newsman to the field office or to the temporary field headquarters if such a temporary field headquarters has been established in the area.

Only SACs or ASACs should participate in question-and-answer interviews with representatives of any news medium at the scenes of fast-moving developments in FBI cases. In emergency situations, however, Special Agents can relay reporters' questions to the SAC by telephone or radio; and the SAC's responses thereto can be furnished to the reporters in the SAC's name by a Special Agent. In other than such emergency situations, Special Agents should courteously refer newsmen to the SAC or ASAC for answers to their questions; and Special Agents' investigative responsibilities attendant to such fast-moving developments must take precedence over questions or inquiries of newsmen.

No FBI employee should knowingly furnish an erroneous, deceptive, or misleading answer to a news media inquiry. In the overwhelming majority of cases, an unequivocal and definitive answer can be given reporters' questions regarding whether the FBI is, or is not, investigating a specific criminal act, as well as the reason why we have or have not instituted investigation. However, in kidnap-for-ransom cases and related crimes involving a threat against human life, neither the fact that the crime has occurred, nor the fact that the FBI is investigating it, should be disclosed or confirmed without the approval of the substantive investigative division and the External Affairs Division.

Due to the sensitivity of many banking-type institutions to publicity concerning the amount of loot obtained in robberies, burglaries, and larcenies of financial institutions, such information should not be disclosed to news media without the concurrence of the General Investigative Division and the External Affairs Division.

SECTION 6. PUBLICATIONS, PRESS, AND PUBLIC CONTACTS

Under no circumstances should any employee ask or suggest that a newsman withhold information from the public without the concurrence of the substantive investigative division and the External Affairs Division.

5. Fugitive Publicity

News releases and other public disclosures designed to solicit public cooperation in the apprehension of FBI fugitives may contain more facts about the fugitive's criminal background than are permissible in news releases and announcements regarding arrests.

In publicity regarding FBI fugitives, extreme care should be taken to avoid statements that brand a fugitive as guilty of a crime for which he has not been convicted. Arrest numbers or other data that identify a photograph as having been made in connection with a past arrest or imprisonment should not appear in photographs of fugitives that are furnished to news media.

Field offices should coordinate all fugitive publicity with the Special Investigative Division and the External Affairs Division; and they should not hesitate to consult the External Affairs Division regarding questions or problems that arise in any area of news media relations.

6. Liaison With News Media

SACs who consider it necessary or advisable to do so may use one or more experienced Special Agents to assist in facilitating prompt and effective liaison with the news media. Such Agents will not be spokesmen for their field offices. They may furnish information to news media in the SAC's name after it has been approved by the SAC. They also may assist in preparing news releases, as well as responses to news media inquiries. These Agents should devote no more time to such news media liaison duties than is absolutely necessary.

It is the intent of these guidelines to facilitate a more open stance and, thereby, a mutually beneficial relationship between FBI and news media representatives. SACs, as well as other employees acting for them in news media relations, should be as responsive as practical and possible to inquiries and requests made by newsmen. The term "No comment" should be avoided except when its use is absolutely necessary. If an SAC does not know the answer to a newsman's question, he should have no hesitancy in stating, "I don't know," and/or, depending upon the nature of the inquiry, telling the newsman that he will contact him (the newsman) as soon as he has information that can be furnished to him.

SACs should avail themselves of every opportunity to meet and become well acquainted with leading citizens throughout their field divisions, including representatives of all important news media. They should seek to cultivate a personal, as well as an official, relationship with these individuals to the fullest extent that the demands of other duties make possible.]

SECTION 6. PUBLICATIONS, PRESS, AND PUBLIC CONTACTS

B. FBI LAW ENFORCEMENT BULLETIN

This publication is issued the first of each month by the Bureau for the benefit of law enforcement agencies.

1. Contents

- a. Foreword by the Director
- b. [Fugitive notices and interesting or unusual fingerprint patterns
- c. Articles and features designed to inform law enforcement officers of new, but proven, programs and techniques to enhance their professional capabilities
- d. Items alerting law enforcement officers to dangerous weapons or techniques utilized by the criminal element]

2. Distribution

Limited to law enforcement officers and others engaged in or having a legitimate interest in law enforcement work

3. Filing and indexing

- a. In a 66 classification file, bound on the side, and fully indexed. Informative matter to be indexed under subject matter. For uniformity, the Bureau is to forward by routing slip to all divisions each month an indexing list of the basic and pertinent items to be indexed. Index cards are to be prepared by each office. Any additional items not listed but considered to be worthy of indexing by a particular office should also be indexed. The indexing lists are to be destroyed after the field office inspection by FBIHQ.
- b. This file may be destroyed when it is over five years old. Retain index cards.
- c. Current copy should be placed in bookcase, available to all Agents.
- d. Deleted

4. [Suggestions and submissions

- a. Each field office is required to submit three suggestions for byline articles from each state within its territory. Prior to submitting suggestions, proposed authors may be approached to determine their willingness to prepare an article and to identify the scope of their topic. However, proposed authors should not be asked to prepare a manuscript until the Bureau notifies the field office that the suggestion has been accepted and the article is requested. In contacts with any proposed or potential authors, absolutely no representations should be made which would obligate the FBI to any publishing commitments since many factors determine which articles received are ultimately published.
- b. In suggesting featured articles, consideration should mainly be given to manuscripts concerning proven programs and techniques of law enforcement which may be of significant value to other agencies. Suggestions should be concerned with training, research, or operational matters. Avoid items of a "newsletter" nature and matters which have a limited scope of interest in the profession.
- c. Each field office should be alert to exceptional photographs which could be recommended for use as a cover for the magazine. The Bureau wishes to project on the Bulletin's cover the best image of law enforcement. Attention-getting photographs showing officers giving aid to helpless citizens, protecting the weak, comforting the injured, or apprehending the guilty are examples of those that should be recommended when they come to the attention of field offices.
- d. Transmit all material for the magazine to the Bureau under the caption:

FBI Law Enforcement Bulletin
Research Section (External Affairs Division)]

SECTION 6. PUBLICATIONS, PRESS, AND PUBLIC CONTACTS

C. SPEECHES

1. The speech program is the personal responsibility of the SAC, and the SAC or ASAC should handle principal commitments. If neither available, these can be handled by an experienced and well-informed Agent approved for the commitment by the SAC or ASAC. Good judgment should dictate when a manuscript should be submitted to FBIHQ for approval in advance of a speaking engagement, particularly in regard to radio and television appearances.
2. It is not necessary to advise FBIHQ of each speaking engagement. Each office will maintain for a minimum of one year and one regular office inspection a control file in connection with acceptances and declinations of speech invitations. Each year on January 10th and on July 10th. each office will submit to FBIHQ a statistical report of speaking commitments handled. This will be divided into engagements by the SAC, the ASAC, and other Agent Supervisors; and will be further subdivided into speeches as well as radio, television, and Career Day appearances by these three groups. [In addition, identify the 10 most important speeches given during the 6-month period covered by the report and indicate who gave them.]
3. Each office should maintain a speech material file for the use of speakers. This should include Law Enforcement Bulletin items, interesting case material, magazine articles, research literature, newspaper clippings pertaining to law enforcement matters of interest, and items of value in connection with public appearances of Bureau representatives. In addition to being maintained in current status, this speech material should be indexed as to subject matter in the office files.

D. INTERESTING CASE WRITE-UPS

1. Write-ups of interesting cases may be:
 - a. Requested by the Bureau
 - b. Voluntarily submitted by the office of origin
 - c. Suggested by other offices
2. They are prepared concerning cases of:
 - a. Major importance
 - b. Public interest
 - c. Unusual and effective investigative techniques
 - d. Novel investigations of human interest
3. They are prepared:
 - a. Double spaced
 - b. Bureau file number to appear in upper left corner of first page
 - c. Title includes names and aliases of convicted subjects
 - d. Accurately
 - e. After a review of the entire file
 - f. In chronological or logical order, with all dates definite
 - g. Showing the actual time which is to be served under sentence
 - h. To include as many pertinent photographs as possible to make the write-up interesting. The photographs should not necessarily be of subjects alone but should be of paraphernalia used by the criminal, photographs of unusual loot obtained, scenes of various locales, etc. If photographs submitted do not belong to the FBI, it is necessary to inform the Bureau of their source and whether the owner of the photographs has any objection to their being reproduced in publications.
 - i. Each portion of the write-up should be documented as to the identity of the report or other communication from which facts were taken. The documentation should be set off by parentheses and follow immediately the portion of the write-up to which it pertains.

SECTION 6. PUBLICATIONS, PRESS, AND PUBLIC CONTACTS

4. Do not:
 - a. Identify law enforcement officers by name but by title and NA affiliation
 - b. Show aliases of subjects of Dependents Assistance Act of 1950
 - c. Show aliases of victims of WSTA cases
 - d. Use complicated sentence structure
 - e. Use technical references to statutes
 - f. Express personal opinions
 - g. Reveal identity of confidential informants
 - h. Use Bureau expressions like "the subject" and "the Bureau"
 - i. Prepare interesting case write-ups on juveniles, sex offenders, and parole violators but submit these by letter
 - j. Use adjectives excessively
5. Transmittal
Set forth all data necessary for Bureau's consideration at the beginning of write-up and then follow with interesting case data. Transmit by routing slip, Attention: External Affairs Division.
6. Dissemination
[Field Offices will be advised by routing slip when new write-ups are prepared. If copies are desired, an appropriate letter should be submitted to the Bureau, Attention: External Affairs Division, setting forth the specific use for which the write-up is intended. In instances where write-ups, either those previously prepared or those to be published in the future, may be released outside the Bureau, it will be necessary to first obtain Bureau approval.]
7. Interesting case control file
A copy of all communications concerning the dissemination of write-ups outside the Bureau is to be placed in the Interesting Case Control file. These communications should contain the identity of the person to whom the write-up is being made available, as well as the purpose for which it is to be used.]

E. CIRCULAR LETTERS, TRADE AND BUSINESS PUBLICATIONS

1. Circular letters must be approved in advance by the Bureau and sent in by the office initiating the request.
2. SACs may approve the use of a circular letter directed to banking-type institutions within their own divisions to expedite circularization of known serial numbers of money included in the loot taken in a bank robbery, bank burglary, or bank larceny. On a highly selective basis, on approval of the SAC, leads may be set out to contiguous offices to circularize banking-type institutions in those divisions, and the Bureau should be notified that this action is being taken unless advised to the contrary. Communications setting out such leads must include sufficient facts to enable the Bureau to properly evaluate and justify the additional circularization. In all other cases prior Bureau approval must be obtained in accordance with existing rules governing circular letters. In all instances the circular letter must include the following:
 - a. A brief concise statement concerning the bank robbery, bank burglary, or bank larceny and the fact that included in the loot or money taken was money, the serial numbers of which are known
 - b. List of known serial numbers according to denomination, series year if known, alphabetical order, and numerical sequence
 - c. A statement that the matter is to be treated confidentially
 - d. A cautionary statement that no bank employee should take any action which would tend to jeopardize his or her life or safety
 - e. The address and the telephone number of the field office with a statement that any person should contact the field office by calling collect

SECTION 6. PUBLICATIONS, PRESS, AND PUBLIC CONTACTS

3. Auxiliary offices are to advise the office of origin by letter of the results obtained through a circular letter. Office of origin should summarize the results in its next report.
4. One copy of the circular letter is to be filed. A list of addressees is to be attached. Upon the receipt of a reply, the addressee's name is to be checked to indicate this fact. Replies which are entirely negative should not be filed unless there is reason for doing so. Only negative replies are to be destroyed after handling in accordance with item 3 above. Sub-A files may be used when the number of replies to be filed is large.
5. A 66 file may be opened to retain copies of circular letters distributed in order to facilitate the handling of incoming inquiries and replies. Only one copy of each circular letter is to be filed therein. If the 66 file is maintained, the material therein is to be destroyed after it is a year old if it is no longer needed.
6. Circular letters and other information to be distributed or released to the public must be so worded as to be unobjectionable to any race, [color, religion, sex, or national origin.]
7. Trade publications may, with advance Bureau approval, be used to publicize information concerning fugitives known to be active in particular trades, businesses, or professions. The field office where the publication is located should check its indices concerning the publication, as well as the person or persons who will have to be contacted, before seeking Bureau approval, and sufficient identifying data should be furnished so that an appropriate Bureau indices check may be made.

[F. RADIO [AND TELEVISION] BROADCASTS

Radio [and television] broadcasts without advance Bureau approval may be made in hot-pursuit fugitive cases. Care must be exercised in broadcasting a license number believed used by fugitive as it may be disposed of to an innocent third person.

G. FIELD OFFICE LISTS

1. Law enforcement officials

On March 1 of each year all field offices shall forward to the Bureau a communication pertaining to a list of law enforcement officials and agencies whose cooperation might be helpful. One of the two following procedures should be used:

- a. (1) On March 1 of each year all field offices shall forward to the Bureau in duplicate, and with a space left between the officials of each Department, the list described above. Indicate by an asterisk any change which was not previously called to the Bureau's attention.
 - (a) Chiefs of police
 - (b) Sheriffs
 - (c) State police or highway patrol commanders and ranking officers in command of districts
 - (d) U. S. Marshals and deputies
 - (e) Ranking Federal law enforcement officers
 - (f) Wardens of penal institutions
 - (g) District attorneys or county prosecutors
 - (h) Railway police (if desirable)
 - (i) Officers receiving law enforcement bulletins
 - (j) Any other officials who receive identification orders
- (2) Changes in the list are to be reported in duplicate to the Bureau as they occur.

SECTION 6. PUBLICATIONS, PRESS, AND PUBLIC CONTACTS

(3) Letters advising the Bureau of changes are to be set up as indicated:

Page No.	City	Deleted	Added	Remarks
4	Center City, Iowa zip code	John M. Doe, Sheriff Wayne County	R. Roe, Sheriff Wayne County	
7	Jonesville, Iowa zip code	Richard Brown Chief of Police		Deceased successor not named
3	Brownsville, Iowa zip code	George Smith Constable	George Smythe	To show correct spelling

- b. As an alternative, offices which believe it will save time and material may make any necessary changes as they occur in this list by typing the appropriate change on a strip of paper which will be taped over the item to be corrected. [The date of the revision will be typed on a strip of paper and will be taped under the page number of the amended page.] The page bearing the correction may then be reproduced on Xerox equipment and the new copy inserted in place of the corrected. Copies of the amended pages may then be furnished to the Bureau and interested employees in the offices. In this procedure, it is necessary to appropriately flag each individual change so that it may be readily identified without the necessity of a name-by-name review. Offices using this procedure must make the customary annual review of the list and submit a letter to the Bureau on March 1 of each year advising that the list the Bureau has is accurate and current.

SECTION 6. PUBLICATIONS, PRESS, AND PUBLIC CONTACTS

2. Identification orders, wanted flyers, and check circulars
Each field office must maintain a mailing list composed of individuals and organizations to which identification orders, wanted flyers, and check circulars are to be sent. Each field office must review annually its mailing list in order to see that no data is sent to firms which have ceased business or have merged with other organizations. A survey should be conducted by Agents each year by every office, at time field office mailing list is purged, to determine whether additional names of individuals and businesses should be added to field office mailing list.
- a. Addressograph plates are to be prepared at Bureau upon receipt of field request. (Bureau will prepare, on its own initiative, Addressograph plates for new FBINA graduates.) Title of position is used rather than name of incumbent.
- b. Decide what organizations, individuals, or concerns are to appear on list.
- (1) Quality of assistance addressee is in a position to give
- (2) Cooperation which has been afforded
- (3) Following must appear on list:
- | | |
|--|----------------------------|
| Bureau of Alcohol, Tobacco
and Firearms | Missions Providing Lodging |
| Cooperative Credit Bureaus | Postal Service Inspectors |
| Duly Constituted Law Enforcement Officers | Postmasters |
| FBINA Graduates | Salvation Army |
| Hotels | Secret Service |
| Immigration and Naturalization Service | [U. S. Customs Service] |
| | U. S. Marshals |
- (4) Following may appear on list:
- | | |
|--|-------------------------------|
| Automobile Clubs | Navy Shore Patrol |
| Banks | Oil Company Special Agents |
| Car Rental Agencies | Parole and Probation Officers |
| County Attorneys | Plant Quarantine Officers |
| County Coroners | Protective Associations |
| Credit Companies | Race Tracks |
| Detective Agencies | Savings and Loan Associations |
| Enlistment Officers, U. S. Air Force, Army, Navy, Marine Corps | Service Recruiting Officers |
| Employment Service | State Employment Offices |
| Fire Departments | State Hospitals for Insane |
| Forest Service | Steamship Companies |
| Gunsmiths | Telegraph Companies |
| Insurance Companies | U. S. Attorneys |
| Movie Studios | U. S. Magistrates |
- c. Identification orders, wanted flyers, and check circulars are to be furnished newspapers and periodicals only upon their specific request. Should a compelling reason exist for distribution of an identification order, a wanted flyer, or a check circular, such as possible employment of a fugitive by a newspaper or periodical, secure Bureau approval for such distribution.
- d. Give consideration to desirability of circularizing motels.
- e. Veterans Administration (VA) installations should be circularized on identification order fugitives who are veterans. Office of origin has responsibility for instructing other offices to initiate distribution to VA installations in such cases.

SECTION 6. PUBLICATIONS, PRESS, AND PUBLIC CONTACTS

H. INFORMATION TO BE FURNISHED TO THE BUREAU

1. Which does not have a nationwide circulation or interest
 - a. Relating to law enforcement concerning
 - (1) Scientific apparatus
 - (2) Equipment
 - (3) Personnel
 - (4) Methods
 - (5) Economics
 - b. Newspaper clippings, other than items bearing the date line of a national wire service, should be submitted when they concern
 - (1) The FBI, derogatory and complimentary. If possible, show author.
 - (2) Outstanding abuses of parole and probation
 - (3) Outstanding instances of juvenile crime
 - (4) Bad local crime conditions
 - (5) Scientific crime detection experts
 - (6) Bureau police schools only when there is some unusual feature about the publicity. Examples: items setting forth comments made by police officers as to the value of police schools; comments on the caliber of schools in which FBI participates; incidents in which a police officer credits instruction he received in a police school as enabling him to capture a fugitive, solve a case, or otherwise perform his work more efficiently. (File in individual pertinent school files clippings relative to each police school in which field participates.)
 - (7) Police training in colleges and universities
 - (8) Aggravated sex offenders
 - (9) Matters appearing in the press concerning the names of prominent persons who are mentioned in connection with Bureau cases. These matters also include wire service stories mentioning directly or indirectly persons of prominence in pending investigations being handled in your division. Forward such matters immediately and if there is any question as to what action should be taken ask for specific instructions.
 - (10) Items of interest by nationally syndicated columnists need not be submitted if it is apparent that such items will come to the Bureau's attention through its review of Washington, D. C., newspapers. Columns of interest by writers syndicated regionally should, of course, be submitted.
2. Method of preparation for transmittal
 - a. Mount the clipping on form FD-350 within the borders shown.
 - b. Do not fold the clipping except in the case of a very large picture or in the case of a single word in a headline too long to fit in the allotted space. Make certain the clipping is placed evenly on the paper and does not hang over its edges. If necessary, a second page may be used and the only requirement is that a margin at least 1 1/2 inches deep should be left at the top of the page.
 - c. The large block on the right side of FD-350 has space for the insertion of the names of more than one newspaper. The names of newspapers clipped may be overprinted in this space. Placing the page number on the line in front of the name of the newspaper will serve to designate which paper the clipping is from. The page number may be written in longhand. Only the page number on which the article begins should be shown. If overprinting is not used, required information other than page number should be typed.
 - d. Show whether the matter mentioned is being investigated.
 - e. Insert staples horizontally at the top and bottom and vertically at the sides of all clippings. Use only a sufficient number of staples to hold the clipping securely to the paper.
 - f. Do not mutilate or mark clipping in any manner by underlining or circling words or by drawing arrows to direct attention.
 - g. No cover letter needed when submitting clippings unless clarification is required for a particular clipping. This may be handled by routing slip, letter, or airtel accompanying clipping in question.

SECTION 6. PUBLICATIONS, PRESS, AND PUBLIC CONTACTS

- h. If an item to be submitted appears on more than one page of the newspaper, the words "Continued on page...", the subheadline on the continued page, and the words "Continued from page..." should not be mounted.
 - i. Mounted clippings should read from top to bottom, column by column, from left to right.
 - j. All clippings must be complete.
 - k. Only one copy of a clipping need be submitted except that two copies of all items pertaining to actual or possible civil rights violations should be forwarded.
 - l. Include clippings with other mail being sent to Bureau on the day that the clippings appear in the local paper. Forward clippings from resident agencies the day they arrive at headquarters city.
3. Resident Agents must be alert for material appearing in the local press.
4. Submission of publications of security interest to the Bureau
- a. General principle governing submissions

The Bureau desires to receive publications of security interest at [FBIHQ] for purposes of information, research, and intelligence. Consequently, it is requested that evidentiary copies of publications be retained in the field and only nonevidentiary copies be forwarded to the Bureau by routing slip.
 - b. Manner of handling and forwarding nonevidentiary copies of publications
 - (1) Nonevidentiary copies of newspapers, magazines, journals, periodicals, news bulletins, and books, obtained regularly (by subscription or repeated purchase) and forwarded to the Bureau, need not be identified as to source. They should be submitted via ordinary mail by routing slip (marked for the attention of [Section IS-3, Intelligence Division]) unless transmittal by cover letter has been specifically requested. Routing slips may be used to notify the Bureau of routine administrative matters, such as temporary suspension of a publication (e.g., during summer months, lack of funds), temporary delay in obtaining or receiving particular issues of a publication, or other information which will keep the Bureau informed relative to the status of these publications. To avoid confusion, nonevidentiary copies which have been marked for identification (source, Agent, date, and place of acquisition) should be further annotated: "Not Evidence."

Letters should be used in connection with initiating action or ceasing action to obtain publications desired by the Bureau; to call to the attention of the Bureau specific items of information connected with these publications; and in those instances in which good judgment dictates that certain circumstances or information should be recorded in letter form.

- (2) Each SAC and each legal attache must keep the Bureau, attention [Section IS-3, Intelligence Division], informed on a current basis regarding publications (including books) of potential interest that are not included in the current list of publications which is supplied periodically to the field and to the legal attaches. These publications would include those published by subjects of security or counterintelligence investigations and publications which may otherwise have a security or counterintelligence significance.
- (3) Each SAC and each legal attache should insure that the handling of publications for which his office is responsible is being given adequate supervision at all times. Subscriptions to these publications should be followed closely to insure that the publications are received at the Bureau on a current basis. The Bureau should be advised of the expiration date of the subscription to each publication in sufficient time to enable the Bureau to determine the necessity for renewal.

SECTION 6. PUBLICATIONS, PRESS, AND PUBLIC CONTACTS

- c. Purchase of individual publications at Bureau request
When the Bureau requests a field office to purchase and forward one or more copies of publications of security interest, it is desired, unless otherwise specifically stated, that nonevidentiary copies be forwarded. With respect to these specific Bureau requests for the purchase of individual copies of publications, the requested nonevidentiary copies should be forwarded to the Bureau by routing slip via ordinary mail.
- d. Obtaining and retaining evidentiary copies of publications in the field
When the submitting office determines, or is advised by the Bureau, that a certain issue of a publication (which has already been forwarded to the Bureau) is deemed to be of sufficient importance to warrant the obtaining of an evidentiary copy of that issue, a copy thereof should be obtained through live informants or by having an Agent purchase a copy at a public outlet for that publication, if confidentially feasible. The evidentiary copy, bearing complete identifying data, should be retained as evidence in the field office, and the Bureau should be so advised by letter, setting forth complete identifying data concerning the evidentiary copy, together with the caption and file number of the file in which the evidentiary copy is retained.
- e. Transmittal of evidentiary copies of publications to the Bureau
Instances in which the field will transmit evidentiary copies of publications to the Bureau will be limited almost exclusively to the submission of copies of foreign language publications for translation of certain material for use as evidence. In these instances, it is required that:
- (1) Each copy submitted bear complete identifying data
 - (2) The material be forwarded in sealed envelopes labeled "Evidence"
 - (3) The material be forwarded via registered mail
 - (4) The cover letter of transmittal be marked for the attention of the FBI Laboratory; state clearly that it is contemplated that the publications (and translations thereof) will be used as evidence; identify clearly the enclosed publications as to title, place of publication, and date of issue; show the method of transmittal of the evidence to the Bureau; and indicate the desired disposition of the evidence.
- f. Calling attention of Bureau to publications of security interest
When a field office obtains an evidentiary copy of a publication which it desires to call to the Bureau's attention, a letter should be addressed to the Bureau to that end. Title, author, publisher, and the general nature should be very briefly set forth, together with the identifying data proper to the evidentiary copy. The letter should be informative, not requiring an answer. A nonevidentiary duplicate copy of that publication should be enclosed with the letter, if readily available. If a nonevidentiary copy is not readily available, that fact should be stated in the letter. If the Bureau desires to obtain a nonevidentiary duplicate copy of the publication for review, efforts will be made to obtain it through the appropriate field office. If not obtained, the office possessing the evidentiary copy will be requested to forward to the Bureau a Photostat thereof.

SECTION 6. PUBLICATIONS, PRESS, AND PUBLIC CONTACTS

I. VISITS TO FIELD OFFICES

1. Non-Bureau governmental officials
 - a. Do not discuss Bureau policies, plans, or relationships. Courteously advise the visitor that inquiries concerning such matters are to be made at the Bureau at Washington.
 - b. Advise the Bureau of the visit, identity of the visitor, purpose, matters discussed, courtesies extended, and observations of interest to the Bureau.
2. Departmental officials
 - a. Be courteous.
 - b. Do not offer office space, clerical and stenographic assistance, or chauffeuring in Bureau automobiles.
 - c. Do not furnish information unless prior notification has been received that the official would contact the field office for information. If no notification received, before furnishing information clearance must be obtained from the Bureau.
 - d. Advise the Bureau in case of doubt.

J. MISCELLANEOUS

- [1. [Firearms, defensive tactics,] and disarming demonstrations
Are to be confined to law enforcement groups.
2. Credentials
Are to be exhibited to all persons interviewed in such manner that the person to whom shown has an opportunity to observe and understand the connection of the Agent with the FBI.
3. Law enforcement officials
 - a. Contact with
 - (1) Contact must be maintained with law enforcement officials for the purpose of securing information of violations of Federal laws within the jurisdiction of the Bureau.
 - (2) Agents are to call on police executives when in their cities unless such visits would be so frequent as to be embarrassing.
 - (3) Local law enforcement agencies should be advised by letter of the disposition of prosecutive action taken in Federal court in cases

SECTION 6. PUBLICATIONS, PRESS, AND PUBLIC CONTACTS

referred to Bureau by local law enforcement agencies or where Bureau fugitives are taken into custody by local law enforcement officers. They should also be advised of violations of local laws coming to the attention of the FBI.

b. Visits to Washington

When the field requests special courtesies be afforded certain individuals, including law enforcement officers, coming to Washington, D. C., the communication so advising the Bureau shall contain biographical data and a brief summary of information in the field office files concerning the visitor.

When law enforcement executives are contemplating a visit to the Bureau at Washington, D. C., ask them to call at the office of the [Assistant Director of External Affairs Division, Room 5634,] Justice Building.

c. Letters of commendation, congratulations, appreciation, and condolence

When letters of commendation, congratulations, appreciation, or condolence from the Director are recommended by the field, such recommendations should be submitted promptly. They should include the specific facts on which the recommendation is based, full identifying data and address of the citizen, and the result of a search of the field office indices concerning the citizen. [Form FD-468 may be used.] In connection with the election of officers of police associations at conventions covering more than one field division territory, the field division in whose territory the convention was physically held is responsible for submitting any recommendations for letters of congratulations. The office submitting such request should summarize briefly the relations with these officers, incorporating any derogatory data which might preclude such letters. Inasmuch as the recommending office is not likely to possess all data, pertinent other field divisions should submit a brief, supplemental summary concerning officers recommended for letters who reside in their territory.

4. Inquiries concerning status of Bureau cases

When a state official has expressed interest in the prosecutive status of a Bureau case, for a legitimate reason, such as deferment of state prosecution pending the outcome of the Federal case, insure that such official is kept appropriately advised, including the final outcome of the matter.

5. U. S. Cabinet officers, Senators, and Congressmen

If an SAC receives an inquiry from a Cabinet officer or U. S. Senator or Congressman concerning an official matter, it should be brought to the Bureau's attention immediately.

K. SOURCES OF INFORMATION

Definition

An individual, organization, or concern willingly furnishing information to employees frequently enough to justify making a record where the source need not be protected. If occasionally the source must be protected, this may be done. If sources must be constantly concealed, they become informants or confidential sources and must be handled as such.

1. Index

Index card (3 by 5 inches) must be made up to contain:

- a. Names
- b. Addresses
- c. Organization or concern
- d. Type of information furnished
- e. Date of development

SECTION 6. PUBLICATIONS, PRESS, AND PUBLIC CONTACTS

Included in the index may be individuals in Government, business, or industry. Do not include law enforcement officers unless they are unusually cooperative or furnish special types of information. Set up the index alphabetically, geographically by states and towns; alphabetically in the subdivisions; and alphabetically by AEA facility, or by type of information.

Maintain the index where it is available to all Agents. An index may be maintained in resident agencies having approved office space which can be securely locked and having locked cabinets in which records can be kept. Source of information cards may be kept by resident Agents not having approved office space but working out of their homes whenever the SAC feels it is practicable to do so and the cards will be securely retained in a locked, steel file cabinet. Cards shall be kept as in the field office. The cards shall pertain only to the territory covered; under such circumstances there shall be no duplicate cards in the field office. Cards are to be deleted when obsolete or when it is determined a source is deceased.

Index sources of information in the general office index; do not remove such index cards at the time obsolete cards are deleted from the special source of information index except when it has been determined that source is deceased, at which time general index card can be destroyed immediately. Under all other conditions the general index cards shall be retained for 20 years subsequent to the removal of cards from the special source of information index.

2. Files

Do not make up files or write memoranda for the preparation of sources of information.

3. Security and extremist sources of information

Every six months a letter of justification (FD-401) should be submitted to the Bureau requesting continuation of payments to security and extremist sources of information. Follow instructions set out in section [130I,] item 2b, volume IV, of the Manual of Instructions. If the security or extremist source of information is not being paid on Bureau authorization and is being used regularly, the Agent handling the source of information must dictate a memorandum to the SAC for the file containing the same certification as to stability and reliability as required by payment letters.

4. Gifts should not be given to sources since such actions might be misconstrued.

L. [PUBLIC CONTACTS

1. Public contacts are defined as persons who, because of their positions, can and do render extraordinary service or provide unusual and highly valuable assistance to the FBI.
2. Immediately upon assuming the duties of SAC, such SAC should visit leading officials located in the field division.]

SECTION 6. PUBLICATIONS, PRESS, AND PUBLIC CONTACTS

3. Persons to be contacted shortly after the arrival of the SAC include:

- a. Federal judges
- b. U. S. Attorneys
- c. Only outstanding state judges
- d. Governors
- e. Leading state and county prosecutors
- f. State attorneys general
- g. Officers of the National Association of County and Prosecuting Attorneys
- h. Executive secretary of state chamber of commerce
- i. In the principal cities:
 - (1) Mayors
 - (2) Chiefs of police
 - (3) Officials of newspapers, including publishers, managing editors, city editors of leading newspapers, heads of newspaper wire services
 - (4) Managers or owners of leading and most important radio and television stations
 - (5) Heads of outstanding or more important civic clubs, such as Kiwanis, Rotary, Lions
 - (6) Executive secretary or director of chambers of commerce
 - (7) Heads of Federal intelligence agencies
 - (8) Outstanding leaders of Government and business
 - (9) Heads of larger universities
 - (10) Outstanding religious leaders of any faith, such as the Bishop of a diocese of any faith or the leading Rabbi
 - (11) Top representatives of airlines
 - (12) Managers of leading airports
 - (13) Top representatives of railroads
 - (14) Managers of leading railroad stations
 - (15) Top representatives of telephone companies
 - (16) Top representatives of Western Union
 - (17) Managers of the most outstanding and important hotels
 - (18) Heads of better business bureaus
 - (19) Heads of leading banks
 - (20) Influential minority leaders

M. NEWS MEDIA CONTACTS

As indicated in subsection L, paragraph 3i, (3), above, officials of leading newspapers including minority-oriented newspapers, must be contacted by SACs. Smaller newspapers and other news media are not to be neglected, however, and, throughout his tenure in a field office, the SAC must insure that his press contacts are continuously effective. The number of contacts made by him and representatives of his office and the material furnished news media will be considered in appraising the maximum effectiveness of this program.

SECTION 6. PUBLICATIONS, PRESS, AND PUBLIC CONTACTS

[N. BUREAU-WIDE INFORMATION PROGRAM REGARDING MATTERS OF NATIONAL INTEREST
This program is coordinated by the External Affairs Division and is devoted primarily to supplying SACs facts regarding current happenings, including both administrative and investigative developments, that are topics of nationwide press coverage and public interest.

All such communications to SACs bear the caption "BUREAU-WIDE INFORMATION PROGRAM" and are in the form of either teletypes or airtels, dependent upon the exigencies of the situation.

The purpose of this program is to assure that each SAC possesses the key facts concerning important happenings anywhere within the FBI that command widespread public interest. Information furnished to SACs under this program should prove helpful to them, as well as to other FBI personnel, in answering questions, correcting misunderstandings, and dispelling false rumors that may exist either within or without the ranks of the FBI. In some instances, however, the information may be of such a nature that it cannot be disclosed in whole or in part to outsiders. In fact, occasionally it is necessary to restrict discussion and disclosure of the information even within FBIHQ and field offices. Guidelines furnished on each communication should be strictly followed.

FBIHQ and field office personnel should promptly bring to the attention of the External Affairs Division all current items and developments that they feel merit consideration for inclusion under this program.]

SECTION 7. PAYMENTS -- PROPERTY

[A. [TRAVEL EXPENSES - TRANSPORTATION ALLOWANCES

[Travel Expense - Expenses for travel include cost of transportation:
 [per diem, mileage allowance for use of personally owned car, auto and taxi
 [hire, bus rental, and blue slip items incurred by employee; and purchase
 [of gas and oil for Bureau cars.

[Transportation Allowance - Travel is to be performed by most expeditious
 [and economical mode. All travel to be by coach airline accommodations
 [unless circumstances make this impractical or disadvantageous to the
 [Government. Travel by train or boat in most instances is prohibited.
 [When travel performed by automobile, train, boat, etc., travel voucher
 [must clearly show mode of transportation was necessary or advantageous
 [to Bureau. Excess cost resulting from personal desires to use a particular
 [mode will be borne by employee. Use of privately owned automobile authorized
 [on transfers or otherwise if in best interest of Bureau.]

1. Transportation request (GTR)

Employees may obtain tickets for transportation by common carrier by means of a transportation request form, SF-1169, which is designed for the use of persons entitled to transportation at Government expense. A sufficient supply of books, each of which contains 10 requests, and of receipts for GTRs, form FD-254, to meet current requirements must be maintained in each office.

a. Issuance

- (1) The SAC is authorized to issue books of GTRs to Agents for their use and to issue individual GTRs for the use of clerical personnel traveling on official business for the Bureau and others who are entitled to transportation at Government expense. In the absence of the SAC the employee designated to act for him may issue books and individual transportation requests. In these instances the name of the SAC, followed by the initials of the person acting for him, is to be shown on the receipts.
- (2) FD-254 must be executed when book of requests is issued and promptly forwarded to Bureau. Receipt must reflect the numbers of the requests in the book, date, and name and title of individual to whom issued, and be signed by him. Name of person to whom book issued must also be shown on inside cover of book.
- (3) Additional books may not be issued to an employee who has seven or more requests in his possession.
- (4) The Agent to whom a book of GTRs has been issued is then the issuing officer with respect to each individual GTR in the book, and each request in his book must be signed by him in the space provided for the signature of the issuing officer. He may issue GTRs for the use of himself, his dependent, another Agent, or other person traveling on official business for the Bureau.
- (5) When an Agent is separated from the service, any GTRs in his possession should be picked up and retained in the field office for reissue. When a book is reissued, a new FD-254 must be executed and promptly forwarded to the Bureau.
- (6) When an SAC is transferred, his successor must execute a receipt for the requests on hand and send it to the Bureau.
- (7) An employee in travel status may secure additional requests from the SAC in the division in which he is.

b. Use of GTR

- (1) Regulations concerning GTRs are based on orders and rulings by the Comptroller General.
- (2) GTRs to be used for official travel only. Under no circumstances can they be utilized for personal travel. In event personal travel is made in conjunction with official trip, GTR may be issued for official travel only and excess paid in cash by traveler.

PART II

SECTION 7. PAYMENTS - PROPERTY

- (3) GTR forms may be used for transportation of dependents in connection with official transfers. They should be issued only in amount of authorized travel. The names and ages of dependent children should be shown on reverse side of both original and memorandum copies of GTR.
- (4) [Employees must use cash to procure passenger transportation services including excess baggage charges costing less than \$15 unless special circumstances exist which would preclude the use of cash. GTRs are to be used for transportation services costing \$15 or more; however, they are not to be issued (1) for purchase of group of one-way or books of round-trip tickets; or (2) for toll roads, toll bridges, taxicabs, airport limousines, intercity transit, or so-called "Drive-Ur-Self" or for-hire automobile services.]
- (5) GTRs are to be issued to the carrier. They may be issued to travel agencies only for travel within foreign countries (except Canada and Mexico) or between foreign countries, at charges not exceeding those otherwise payable to the carriers used.
- (6) First-class air travel not to be used without prior approval from SAC or Assistant Director unless no other air accommodations are available and there is not sufficient time to obtain such approval. In all instances in which first-class air transportation is used, justification for such use must accompany the voucher claiming reimbursement. Lowest first-class accommodations authorized for rail travel when the elapsed time of the rail journey exceeds four hours. Coach accommodations allowed when elapsed time of the journey is four hours or less. Justification must accompany voucher claims for reimbursement for first-class rail transportation when elapsed time is four hours or less.
- (7) Round-trip tickets should be purchased when positively known or reasonably anticipated that such tickets will be required or used.
- (8) GTR form designed to permit the joint procurement from rail carriers of transportation and pullman accommodations. Where not possible or practical to issue GTRs in this manner, separate GTR may be issued for pullman accommodations. An example of necessity for separate GTRs is a situation in which lowest first-class pullman accommodations are not available when round-trip accommodations obtained. In this instance GTR for round-trip pullman should not be issued and traveler should not issue GTR for return pullman until shortly before return in order to attempt to obtain lowest first-class accommodations.
- (9) When a GTR is issued to procure pullman accommodations only, it should be drawn on the rail carrier that will issue the pullman tickets.
- (10) Many airlines do not permit free stopovers. Each stopover to be made en route for official business must be indicated on GTR. If not indicated on GTR, carrier may not provide stopover, or if stopover is made carrier could demand the difference in cash from the traveler or bill the Bureau for the excess cost. If stopover is made due to official business, and because of circumstances beyond control of employee it was not possible to determine such at time the GTR was issued, the Bureau will pay for any increased cost. Attach to expense voucher covering the travel complete justification for the stopover. If stopover is made for personal reasons, any excess cost incurred must be borne by the traveler.

PART II

SECTION 7. PAYMENTS - PROPERTY

c. Instructions for completion of GTR form

- (1) When an Agent is obtaining transportation for himself only, or himself and others, he signs the GTR as traveler and as issuing officer. The name and official capacity of the other traveler(s) should be shown on the reverse of the memorandum GTR. If the Agent issues a GTR from his book for the travel of his dependents or another Agent, he signs as issuing officer and one of the dependents or other Agent signs as the traveler. A GTR to be issued for purchasing transportation for the use of a clerical employee should be signed by the SAC as issuing officer and the clerk should sign as the traveler.
- (2) The GTR form is self-explanatory and all appropriate blanks should be filled in by traveler. Horizontal lines should be drawn through spaces not used. If space on the front of GTR is not sufficient for insertion of necessary information, use reverse side of form.
- (3) Employees performing official air travel are to pay in cash for excess baggage charges when the total amount does not exceed \$15 plus tax. Reimbursement for such expense is to be made on the regular travel voucher. When excess baggage charges exceed the \$15-plus-tax limit, a GTR may be issued. When a GTR is issued to an airline which operates under the pieces concept for baggage allowance, entries on the GTR should be made in accordance with the following:
 - (a) Where the extra or oversized baggage is to be transported between points, the entire service for which is furnished by the carrier honoring the transportation request, enter in the space on the transportation request following the words "transport not over" the number of pieces of extra or oversized baggage. Also, the abbreviation "lbs." should be deleted and word "pieces" inserted in lieu thereof.
 - (b) Where the extra or oversized baggage is to be transported between points, the service for which is furnished by more than one carrier and the excess baggage allowance concept is different as to the carriers involved, enter in the space on the transportation request following the words "transport not over" the words "see reverse." On the reverse of the transportation request in the space reserved to further identify services required, enter the number of pieces of extra or oversized baggage, the points between which it will move, and the carrier(s) that will furnish the service.
- (4) When GTR is used for charter service, class of service must be identified by charter or contract movement number that covers details of movement.
- (5) Specific information as to respective carriers and types of services authorized must be shown in detail in "via" space or on reverse side of form.
- (6) GTR should be drawn to carrier expected to honor it for services. Under exceptional conditions or due to unforeseen circumstances, GTR may be honored for service by another carrier, subject to charges applicable (1) to class and type of transportation authorized on GTR or (2) to lower class or lesser amount of service, if such actually furnished. In such situations the honoring initial carrier shall require traveler to record in space on reverse side of GTR the name of honoring carrier, service actually received, reason for change, and sign and date the statement. Traveler must also make same endorsement on memorandum card copy of GTR if possible, and, if not, attach written notification of such change to next voucher.

SECTION 7. PAYMENTS - PROPERTY

- (7) When single GTR presented for rail transportation and pullman accommodations, both rail and pullman tickets will be issued by ticket agents, subject to the following exceptions and qualifications. When agent at point where travel begins is unable to assign space because (1) pullman accommodations are not to begin at initial point of rail travel and advance reservations cannot be obtained, (2) pullman is authorized from initial point of rail travel, but the space assignment at such point has been exhausted, or (3) round-trip pullman is authorized and accommodations cannot be obtained in advance for the return trip, such ticket agent will issue a pullman ticket (or tickets) endorsed to show the type and quantity of accommodations and points between which such are authorized in accordance with transportation request issuance. In these situations there is no guarantee that the authorized accommodations will be available; thus, it is incumbent that travelers holding such tickets immediately attempt to obtain actual space assignments upon arrival at points where such are to be furnished. When the accommodations or transportation service supplied is of a different character or a lesser value than that authorized by the tickets, the traveler shall submit a written report of the facts and circumstances to the Bureau, with the voucher covering the travel, identifying the transportation request used to procure transportation involved, and submitting any unused tickets or transportation coupons in his possession.
- (8) When ticket agents are supplied with railroad tickets but not supplied with pullman tickets, rail tickets will be issued and the traveler will be furnished with an "Accommodation Authority Form" covering the accommodations authorized by the GTR. Such "Accommodation Authority Form" will be honored by pullman conductors.
- (9) When ticket agent is not on duty, necessitating that rail and pullman tickets be obtained at nearest available point en route, rail and pullman conductors will honor GTR to first station en route where rail and pullman tickets can be obtained, endorse on back of the request over their signatures points between which GTR was honored without tickets, and secure signature of the traveler to such endorsement. The ticket agent at such en route station, in exchange for the GTR, will issue rail and pullman tickets from the initial points of service as authorized on GTR. When GTR is presented on train for pullman accommodations only, the GTR will be honored by pullman conductor. When requests are presented at a station not supplied with proper ticket forms, at a nonagency station, or at a station at which ticket office not open for sale of tickets, bus driver will honor GTR to destination or arrange for its exchange for a ticket at some intermediate point. When request is exchanged at an intermediate ticket office, it should be endorsed to show clearly that transportation was furnished from point of origin of travel and not from intermediate point at which GTR was exchanged for ticket.
- (10) In any instance in which accommodations furnished are different or lesser type than originally specified on GTR, traveler is required to record in space on reverse side of GTR the actual services furnished and sign the statement. A complete explanation should be furnished to Bureau with voucher covering the actual travel in order that appropriate refunds may be obtained. This explanation may be set forth in a letter or on a report of change in passenger transportation service form, SF-1173, a supply of which may be obtained from the Bureau.
- (11) Under no circumstances should traveler apply for refunds or credits for unfurnished service or unused tickets or portions thereof issued in exchange for GTRs. All unused tickets must be forwarded to Bureau with appropriate voucher, together with reason for nonuse. If no voucher is necessary, unused tickets must be forwarded to Bureau by letter or SF-1173 (see preceding paragraph).

SECTION 7. PAYMENTS - PROPERTY

- (12) Airline accommodations
Reserved space must be canceled as soon as employee learns that such space will not be used. Air carriers' tariffs governing most of major scheduled airlines in continental U. S. (excluding Alaska) specify circumstances under which penalty charges are to be paid by carriers when they fail to furnish accommodations for confirmed reserved space. All payments received from airline carriers for failure to provide confirmed reserved space in case of official Government travel must be by check made payable to Treasurer of the United States. Carrier must be furnished a receipt to acknowledge payment, and check and a copy of acknowledgment are to be forwarded to Bureau for appropriate handling.
- (13) When canceling reservations with other carriers, notify them at earliest date to preclude any possible assessment of cancellation charges.
- (14) If a GTR is lost or stolen, employee accountable must advise Bureau immediately of circumstances surrounding loss and furnish number or numbers of GTRs. If lost or stolen request has been filled out, employee should also advise designated carrier not to honor request should it be presented. If lost or stolen GTRs are subsequently recovered, they should be marked canceled and forwarded to Bureau; under no circumstances should they be used.

2. Expense accounts

- a. An employee claims reimbursement for expenses incurred by submitting a travel voucher form, SF-1012 and SF-1012a (continuation sheet), to reach Bureau by fifth day of month following that in which expenses were incurred. However, regular monthly expense vouchers (SF-1012) in the amount of \$100 or less and not incidental to an official transfer may be paid through office imprest fund. Prepare original and two copies; original and one copy are forwarded to Bureau, and one copy is placed in field administrative file of employee. Official payroll name of employee and his social security number must be shown in space designated as "payee's name." Personnel submitting vouchers are permitted either to dictate them or prepare them in legible rough-draft form for typing by stenographers or typists during regular workday.
- b. Original only must be signed by employee and approving official. Official name must be shown; initials alone are insufficient. SAC is responsible for accuracy of each item. Cash purchases in excess of \$15 must be supported by receipts. Original of receipt must be obtained or an explanation submitted showing that original was retained by vendor in which case a copy may be submitted. Copies of GTRs, receipts (cash purchases in excess of \$15), pullman stubs, copies of telegrams (in excess of \$15), and other documents supporting claims must be placed in an envelope, bearing name of employee, month, and year for which account is submitted, and stapled to reverse side of original SF-1012.
- c. SF-1012 must be prepared in accordance with [Federal] travel regulations, copies of which are in each office. It must specifically show:
- (1) Speedometer readings
 - (2) Official nature of streetcar fares, number, date, and amount
 - (3) Official nature of telephone calls, number, date, and amount
 - (4) Date and time of arrival and departure where overnight lodging is required. When an overnight trip is not required and several points are visited, voucher need only show date and time of arrival and departure from farthest point where duty was performed. Other points are to be shown on voucher but times of arrival and departure need not be. Date and time of arrival and departure must also be shown for all points where daily per diem rate is different.
 - (5) Date of arrival at last-mentioned place of uncompleted duty to be carried forward to subsequent voucher.
 - (6) Travel authority number 271-62 dated 6-1-62
 - (7) When a transfer is involved, place words "transfer letter" (or abbreviation) directly above Order #271-62 and date of transfer letter directly above date of order. This information must appear on household vouchers and vouchers covering transportation of dependents as well as personal expense voucher.

SECTION 7. PAYMENTS - PROPERTY

- (8) Domicile (city and state) at right of official headquarters
 - (9) In "Mailing Address" space, headquarters office to which check is to be sent. Names of resident agency cities should not be used. Where, because of a pending transfer or other factor, there is a question as to which office should be shown as mailing address, list office to which employee is going unless there will be a delay of more than twenty days in leaving office to which assigned at time voucher is prepared.
 - (10) Mode of transportation used for all portions of trip
- d. Specifically, SF-1012 is not to show:
- (1) That travel was made in answer to a subpoena
 - (2) Explanation of expenditure of a confidential nature
- Expenditures of a confidential nature must be explained on FD-37 (blue slip) which is attached to the travel voucher and forwarded to Bureau. Include on FD-37 the date and place, amount, payee, case, circumstances and purpose, signature and title of claimant, and approval of SAC. The beginning and ending dates of periods covered by payments to informants must be shown. Examples of blue slip expenditures: meals and lodging for informants, newspaper ads, space for physical surveillance. Blue slip items for payments to informants must be claimed on confidential vouchers submitted by the SAC or ASAC.

All vouchers containing confidential blue slips and any other matters relating to confidential funds must be sent by registered mail with the inner envelope addressed to the Assistant Director, Computer Systems Division, attention Data Processing Section. No other mail is to be included in the outer or inner envelope transmitting this material to the Bureau. Receipt Card FD-441 should be inserted between inner and outer envelopes.

[A log should be maintained to reflect the mail registry number under which each confidential voucher is sent. This log should be kept until reimbursement has been made for each voucher under the specific registry number.]

- e. Receipts for expenditures should be marked "Paid" and initialed by an employee of the firm. They should be in the name of the person submitting the voucher or explanation provided if other names are used.
- f. Expense voucher will not be approved for payment until memorandum copies of transportation requests issued during the voucher period are on file at the Bureau.
- g. All GTRs issued during one month are to be submitted to reach the Bureau no later than the fifth day of the following month. They may be listed on the traveler's expense voucher covering the month of issue and the memorandum copies of the GTRs forwarded to the Bureau with the voucher.
- h. If a GTR is issued during one month and travel is to be performed during the following month, and there have been no reimbursable expenses incurred which warrant the submission of an SF-1012 expense voucher, the memorandum copy of the GTR is to be forwarded to the Bureau by letter, furnishing anticipated date of travel and stating that actual travel will be shown in the next expense voucher submitted.
- i. If GTR is issued in June for travel in July, voucher or letter showing issuance of GTR should reach Bureau no later than July 5; voucher in this instance should state that travel is to be made in July. The subsequent voucher showing actual travel should indicate that memorandum copy of GTR was forwarded with the June expense voucher.
- j. The use of all tickets purchased with GTRs must be accounted for. Even if no reimbursable expenses are incurred, an itinerary of the travel for which GTRs are issued must be furnished.
- k. GTRs used for dependents should be accounted for on expense voucher submitted by employee.
- l. Alterations or corrections in expense vouchers must be initialed by the payee.

SECTION 7. PAYMENTS - PROPERTY

m. Per diem

- (1) For official travel in the continental United States (the 48 contiguous states and District of Columbia) when lodging away from the duty station is required, the per diem rate is fixed partly on basis for average cost for lodging plus a set rate of \$12 for meals and miscellaneous subsistence expenses. The total amount for the average cost of lodging plus \$12 rate rounded to next whole dollar will be employee's per diem rate for period covered by voucher provided total does not exceed maximum rate of \$25. If total exceeds \$25, the per diem rate will be \$25. Paid receipts for lodging to be submitted with appropriate expense voucher. Where no lodging is required, the per diem rate will be \$12 per day.
- (a) Per diem in lieu of subsistence for periods an employee is away from his headquarters on official business at places outside the continental United States may be claimed at following rates (only one half of maximum per diem rate for a particular area may be claimed for travel of less than 24 hours when a night's lodging is not required):
- (b) Alaska
- I. Prudhoe Bay - \$82
 - II. Barrow - \$75
 - III. Deadhorse - \$64
 - IV. Galena, Kotzebue, Nome - \$52
 - V. College, Eielson AFB, Fairbanks, Ft. Wainwright - \$49
 - VI. Anchorage, Elmendorf AFB, Ft. Richardson, Kodiak, Spruce Cape - \$43
 - VII. Bethel, King Salmon - \$42
 - VIII. Juneau - \$41
 - IX. Annette, Delta Junction, Ft. Greely, Ketchikan, Petersburg, Sitka - Mt. Edgecumbe, Skagway, Wrangell - \$38
 - X. Adak - \$8.30
 - XI. Other - \$40
- (c) Canada
- I. Frobisher Bay, Baffin I. - \$58
 - II. Yellowknife - \$55
 - III. Other - [\$40]
- (d) Canal Zone - \$35
- (e) Hawaii
- I. Oahu - \$37
 - II. Other - \$33
- (f) Mexico
- I. Acapulco
 - 12/16 - 4/14 - \$50
 - 4/15 - 12/15 - \$38
 - II. Other - \$30
- (g) Puerto Rico
- I. Aguadilla (incl. Naval Station Roosevelt Roads West Annex (Formerly Ramey AFB)) - \$38
 - II. Bayamon
 - 12/16 - 5/15 - \$50
 - 5/16 - 12/15 - \$37
 - III. Culebra - \$27
 - IV. Ft. Buchanan
 - 12/16 - 5/15 - \$50
 - 5/16 - 12/15 - \$37
 - V. Mayaguez - \$38
 - VI. Ponce (incl. Ft. Allen NCS) - \$38
 - VII. Sabana Seca
 - 12/16 - 5/15 - \$50
 - 5/16 - 12/15 - \$37
 - VIII. San Juan (incl. San Juan NSA)
 - 12/16 - 5/15 - \$50
 - 5/16 - 12/15 - \$37
 - IX. Other - \$36

SECTION 7. PAYMENTS - PROPERTY

- (h) Virgin Islands
 - 12/1 - 4/30 -[\$49]
 - 5/1 - 11/30 -[\$38]
- (i) Maximum per diem rates for all areas are prescribed by Secretary of Defense and the Department of State. The areas and rates in items (a) through (h) are the ones most applicable to travel of Bureau employees. The maximum per diem rates for areas not listed in items (a) through (h) are furnished to the affected offices.
- (2) Each voucher wherein a claim is made for per diem for less than 24 hours must contain a certification to the effect that extra expenses were incurred. In addition, each per diem claim computed at the maximum rate for a particular area outside the continental United States must be supported by a certification that cost for a night's lodging was incurred.
- (3) SACs are responsible for attaching a letter to all vouchers wherein a claim for per diem in excess of 20 days at one temporary duty station is made. This letter should advise the case load at the temporary duty station and contain recommendations of the SAC as to whether additional Agents should be assigned to the resident agency covering area of temporary duty station. If per diem attributable to Bureau-ordered special, satisfactory merely to attach notation on voucher to that effect identifying the special.
- n. An advance of funds not to exceed \$750 may be applied for when a special assignment will exceed 21 days through the use of SF-1038 showing dates of assignment, where check is to be mailed, and approval of SAC or immediate supervising official.
- o. Reimbursement for use of personally owned automobile is at rate of 12 cents per mile. Bureau authorization required for use of personally owned automobile on official business for period in excess of 10 consecutive days and for any official travel outside the division except official travel to Washington, D. C., for in-service training, lecturing, conferences, etc., and return. When such authorization has been received, certification of that fact and date thereof on travel voucher claiming reimbursement must be made. SAC or, in his absence, ASAC may approve use of personally owned automobile on official business within his division for period of 10 days or less and for travel to Washington, D. C., as described above. In these instances letter of justification in duplicate must accompany expense voucher claiming reimbursement. Letter should be prepared by claimant; must be approved by SAC or, in his absence, ASAC. If travel is on consecutive days and extends into new travel voucher period, reference is to be made on latter to letter of justification accompanying prior voucher.
- p. When traveling by air, any necessary excess baggage should be shipped by "accompanying airfreight" wherever feasible. Complete justification for any charges for excess baggage carried with the traveler or shipped by airfreight must be included on the travel voucher showing such charges.
- q. Fees incurred for parking meters while using a privately owned automobile on official business are reimbursable. Vouchers must indicate date, number, and amount of each, and that privately owned automobile was used on official business.
- r. Fees incurred for parking meters while using a Bureau automobile are reimbursable. Vouchers must indicate date, number, and amount of each.
- s. When a privately owned automobile is used for personal reasons to conduct official business, payment on a mileage basis plus related per diem is limited to the constructive cost of common carrier transportation and related per diem as prescribed in chapter 1,

SECTION 7. PAYMENTS - PROPERTY

part 4, paragraph 1-4.3 of the Federal Travel Regulations. When a privately owned automobile is used to perform travel pursuant to an official transfer, mileage and related expenses will be paid according to the rates prescribed by chapter 2, part 2, paragraph 2-2.3b of the Federal Travel Regulations.

- t. Claims for taxicab fares exceeding[\$10,]including tip, for travel between employee's home or office and a common carrier terminal must be justified to show a more economical mode of travel could not have been used.

3. Transfer allowances and benefits

- a. Pursuant to the provisions of Public Law 89-516, the Federal Travel Regulations, and Bureau regulations, a summary of the additional allowances and benefits provided when an employee has been officially transferred follows. For complete information concerning these allowances and benefits, see the Federal Travel Regulations.

- b. Written agreement

No allowance shall be paid to or on behalf of an employee or his family in connection with a transfer until the employee signs a written agreement, 3-34b, to remain in the service of the Government for one year following the effective date of the transfer. The effective date of a transfer is the date the employee reports for duty at the new official station. If agreement is violated for personal reasons within the control of the employee, all expenses paid to him or on his behalf are to be refunded to the Government.

- c. Per diem allowance in lieu of subsistence expenses

The employee, as well as his immediate family, is entitled to a per diem allowance for travel in connection with a transfer. Where spouse and/or children are traveling with employee, per diem will be computed for employee on basis of what the average "single" rate for the rooms for lodging would have been plus \$12 per day rate prescribed for meals and miscellaneous subsistence expenses not to exceed the maximum per diem rate of \$25. The per diem rate for the spouse when accompanied by employee will be three fourths of the rate of the employee. When not accompanied by employee, spouse receives same rate as employee. Other members of employee's family, age twelve and over, receive three fourths of the per diem rate of the employee; children under twelve years of age, one half of the per diem rate of the employee.

- d. Travel for purpose of locating housing

Regulations provide for payment of travel and transportation expenses for employee and spouse for one round-trip between localities of the old and new duty stations for the purpose of seeking permanent residence when circumstances warrant. Such allowances are not applicable if one of the transfer points is outside the contiguous 48 states. Duration of such trips, including travel time, must be held to the absolute minimum and under no circumstances be allowed in excess of six calendar days. Prior Bureau approval must be obtained. Form 3-34b must be forwarded to Bureau with the employee's request and justification for the trip. SAC's observations and recommendations must accompany this request.

- e. Temporary quarters allowances for employee and family

A subsistence allowance for employee and his immediate family while occupying temporary quarters prior to obtaining permanent housing incidental to a transfer is allowed where justified. Allowances for temporary quarters are limited to 30 days. Temporary quarters claim must begin not later than 30 days from time employee reports for duty at new station or if not begun during this period then not later than 30 days from date family vacated residence at old station. An additional period of time not to exceed 30 days may be allowed for temporary quarters when employee is transferred

SECTION 7. PAYMENTS - PROPERTY

either to or from Hawaii, Alaska, territories and possessions, Commonwealth of Puerto Rico, and Canal Zone. Reimbursements for expenses are limited to actual costs incurred for meals and lodging (including tips), laundry, cleaning, and pressing of clothes. Expenses shall not exceed following prescribed rates. Daily rate for employee is \$18, \$12, and \$9 for first, second, and third ten-day period, respectively. Daily rate for employee's immediate family is \$12, \$8, and \$6 for first, second, and third ten-day period, respectively. Temporary quarters allowances will not be granted if employee or spouse has performed travel for purpose of locating housing without special approval in advance by Bureau. Such allowances will not be granted if employee has otherwise had adequate opportunity to locate housing. All vouchers must contain a statement by the SAC that the claim for temporary quarters is reasonable and should be processed for payment.

f. Allowances for miscellaneous expenses

These allowances are related to expenses common to discontinuing residence at one location and establishing a residence at a new location in connection with transfers. Allowances in the following amounts will be paid without being supported by receipts or itemized statements indicating the nature of the expense:

- (1) \$100 or the equivalent of one week's basic compensation, whichever is the lesser amount, for an employee without an immediate family
- (2) \$200 or the equivalent of two weeks' basic compensation, whichever is the lesser amount, for an employee with an immediate family

Claims under this category which are greater than allowable unsupported amounts must be supported by signed receipts for the entire amount (not just the excess over the allowable unsupported amounts). Allowable expenses are set forth in [chapter 2, part 3, paragraph 2-3.1b of the Federal Travel Regulations.]

g. Allowances for expenses incurred with real estate transactions and unexpired leases [are set forth in chapter 2, part 6 of the Federal Travel Regulations.]

Employees may be reimbursed for certain costs paid by them incidental to sale of old residence or purchase of a new one or settlement of an unexpired lease. To be eligible for reimbursement for allowed expenses, settlement dates for sale and/or purchase or lease termination transactions are not later than one (initial) year after effective date of transfer. Upon employee's written request, this time limitation for completion of the residence transaction may be extended for an additional period of time not to exceed one year regardless of reasons therefor, so long as the residence transaction relates to the employee's transfer. Under no circumstances can the period of extension exceed one year. [Chapter 2, part 6, of the Federal Travel Regulations] lists those expenses which are and which are not reimbursable. Losses suffered through sale of a residence or termination of a lease are not reimbursable. Maximum amount that can be paid for sale of old residence cannot exceed ten percent of sale price or \$5,000 whichever is lesser, and for purchase of a new home, expenses cannot exceed five percent of purchase price or \$2,500 whichever is lesser. Use Bureau form FD-408 to record reimbursable expenses and submit this form with appropriate voucher. FD-408 must be approved by the SAC of the office in the territory where the residence was sold or purchased.

SECTION 7. PAYMENTS - PROPERTY

- h. All vouchers relative to transfer allowances or benefits are to be submitted as soon as possible. Separate vouchers are to be submitted for real estate claims, temporary quarters, and transportation and storage of household goods. Deadlines for submission of vouchers are:
- (1) Travel expenses on transfer - by fifth of month following month in which travel was performed
 - (2) Expenses for temporary quarters - by fifth of month following month in which temporary quarters were terminated
 - (3) Expenses in connection with real estate transactions and unexpired leases - by fifth of month following month in which settlement was made
 - (4) Expenses for transportation and storage of household goods - by fifth of month following month in which payment was made
 - (5) Allowance for miscellaneous expenses - by fifth of month following month in which permanent residence is established
- i. Expense vouchers covering allowances in connection with real estate transactions, unexpired leases, miscellaneous expenses, and temporary quarters will not be applied to an advance of funds which was granted to cover expenses for transportation and storage of household goods.
- [j. Advance of funds

An employee who has been officially transferred may request an advance of funds from the Bureau for (1) per diem, mileage and related cost when travel on transfer is by privately owned automobile, and (2) subsistence expenses while occupying temporary quarters. Use Standard Form (SF) 1038 to request funds desired. Only one application to be submitted. Attached to SF 1038, memorandum of information covering (1) the number of travel days for which per diem is payable, (2) identification of members of immediate family traveling in the privately owned automobile, and (3) mileage for direct travel between authorized points. For temporary quarters memorandum must show number of people occupying temporary quarters and total days involved. Temporary quarters advances limited to thirty days. Employee's vouchers claiming reimbursement of per diem, mileage and temporary quarters will be used to offset advance of funds granted for these purposes.]



- J. AUTHORITY TO APPROVE LIMITED EXPENDITURES FOR INVESTIGATIVE OPERATIONS
In those instances where it is essential to the successful conduct of an important investigation, SACs are authorized to expend up to \$500 from the confidential fund without prior Bureau Headquarters approval. These expenditures must be highly selective and essential to the investigative operation.

SECTION 7. PAYMENTS - PROPERTY

Instances in which such expenditures may be appropriate include but are not necessarily limited to the following situations:

1. Rental of surveillance plants and support equipment on a temporary basis.
2. Necessary expenditures by Agents working in an undercover or covert capacity.
3. Rental of special automotive equipment for surveillance purposes. (Only when available Bureau equipment is not satisfactory and the case is of major importance.)
4. Other items necessary to the conduct of an investigation not available through normal supply or acquisition channels.

A full accounting must be maintained for such expenditures and at the time that reimbursement is requested from Bureau Headquarters for confidential funds expended, appropriate FD-37 (blue slip) must be executed for each such expenditure.]

PART II

L. RESEARCH MONOGRAPHS

1. Research monographs are prepared on security, criminal, intelligence, and general topics for use of Bureau officials and investigative personnel and to keep interested outside Government officials and agencies informed of Bureau's achievements in discharging its responsibilities.
2. Monographs are to be maintained in field office libraries [and legal attache space,] and afforded the usual security precautions.
3. Monographs are to be made readily available to Agents for use in the field offices, and no impediments are to be placed in the way of their use and application by Agents. However, an appropriate charge-out system must be maintained, even for temporary use.
4. All Agents handling a particular type or types of investigative matters should be routed a copy of the appropriate monograph - security, intelligence, criminal, or general - [which is of interest to them.]
5. The circulation of monographs in the field offices and resident agencies should be handled expeditiously. Monographs should not be held in any resident agency for more than 45 days.
6. [All offices shall maintain a minimum of one copy of each monograph for reference purposes. Destruction of unneeded copies is authorized provided record of destruction is maintained. Legal attaches are authorized to destroy monograph copies when necessary due to space limitations.]
7. Suggestions for the preparation of practical and timely monographs should be submitted to FBIHQ.

PART I

F. RECOGNITION AND AWARDS

The guidelines and procedures set forth hereinafter are consistent with instructions of the Civil Service Commission (CSC) and the policies and guidelines of the Department of Justice as set forth in Memorandum No. 601, Supplement 1, dated 11-24-69.

1. Quality within-grade salary increases

Quality salary increases are to recognize and to reward on a continuing basis employees at all levels who display continuing high quality performance. They are intended to motivate employees to perform continuously at their full capacity and to make salaries relate more closely to the nature of the assignment and the competence with which they are performed. Quality increases may be given to all employees of the Bureau who are presently paid under the Classification Act of 1949, as amended, on a per annum basis, except those already at the top of their grade. This excludes Wage Board employees and those whose salaries are fixed under the Executive Pay Act. Annually employees are advised of the number granted.

a. Authority

The Director of the FBI has been authorized pursuant to section O.137 of Order 271-62 by the Attorney General to grant quality increases in salary to applicable employees at intervals of not less than 52 weeks, within the limits of available funds.

b. Basis and documentation

In order to consider an employee for a quality salary increase, a written recommendation must be submitted with justification in detail based on the following:

- (1) Employee has performed the most important functions of his position in a manner which substantially exceeds normal requirements. Set forth brief description of major job duties critical to success of the total job.

SECTION 4. SERVICES AVAILABLE TO EMPLOYEES

- (2) His work has been highly effective. Include where possible specific examples.
- (3) This exceptional high level of effectiveness has been sustained over a period of time no less than six months and will continue indefinitely. Primary consideration is to be given for quality salary increases at the time annual performance ratings are submitted when high level performance must have been sustained over the entire rating year.
- (4) When viewed as a whole employee's performance merits a faster than normal salary advancement.
- (5) A quality increase is more suitable recognition than a cash award for superior performance under the incentive awards program.
- (6) Other than for a special act or achievement, employee should not have received an award for performance.
- (7) Employee must have served a minimum of 12 months in the same position within the Bureau.

c. Relationship to regular within-grade increases

Quality increases are in addition to regular within-grade increases for "acceptable level of competence." An employee who receives a quality increase does not thereby start a new waiting period for his regular within-grade increase. If, however, such quality increase places employee in step 4 or step 7 of his grade, he must then complete the additional waiting period of 52 weeks required by law toward step 5 or step 8.

d. Relationship to Outstanding annual performance ratings,

An employee who meets the standards for an Outstanding annual performance rating would generally meet the standards for a quality increase. However, other circumstances (e.g., a recent quality increase, cash or honorary award, or application of other policy, regulations, or law) may make a quality increase inappropriate at the time. This does not limit quality increases only to those who receive Outstanding annual ratings. The standards for quality increases were purposely made less demanding and more flexible for recognizing and encouraging especially effective job performance of employees who are unable to meet all of the qualifications for an Outstanding rating but who "perform functions of their position" in a sustained superior manner and give promise of continuing at this level.

e. Relationship between quality salary increases and incentive awards

Quality increases are intended to complement incentive awards rather than replace them. Cash awards will continue to be granted when (1) employee would enjoy the benefits of a quality increase for an insufficient length of time or (2) employee's contribution is so great that a lump sum payment is more fitting. On the other hand, incentive awards will be the only choice (1) where achievements are nonrecurring, (2) in special work situations of limited duration, (3) for recognition of group achievement, and (4) where employees are not subject to the Classification Act.

2. Incentive awards

Incentive awards are designed to improve Government, and particularly FBI, operations and to recognize employees as an integral part of supervision and management. Specifically, awards under this program are designed to (a) encourage employees to participate in improving the efficiency and economy of Bureau operations, (b) recognize and reward employees, individually or in groups, for their suggestions, inventions, superior accomplishments, or other personal efforts which contribute to efficiency, economy, or other improvement in operations, and (c) to recognize and reward employees individually or in groups who perform special acts or services in the public interest in connection with, or related to, their official employment. Awards granted for other than suggestions are to be called special achievement awards. This is a lump sum cash award granted in recognition of either an employee's sustained performance which exceeds normal job requirements for a period of at least six months; or specific acts or services in the public interest connected with, or related to, their official employment.

SECTION 14. SERVICES AVAILABLE TO EMPLOYEES

a. Authority

The Director of the FBI is authorized to give final approval for its incentive awards up to and including \$1,000. Awards in excess of \$1,000 will be referred to the Department for approval. It is the Bureau's policy to afford normal management review and control processes to identify program or operational areas where superior work results warrant award consideration.]

3. [Suggestion awards]

- a. Employees are encouraged to submit to the Director ideas to improve the efficiency and economy of the Bureau's operations. A form, FD-252, is available for use in submitting suggestions although they may be submitted in any manner desired. An original and two copies of each suggestion are to be submitted. If the suggestion concerns a form, ten copies of the proposed form are to be submitted. Suggestions are to be submitted without delay to the Director.

[Suggestions] which deal with maintenance and repairs, [employee services or benefits, buildings and grounds, routine safety practices,] items of supply which [can] be procured through simple requisition, or proposals which offer no specific means to improve operations [will not be entered into the suggestion award system unless it can be shown they contribute to economy, efficiency, or increased effectiveness of operations. While these ideas are welcome, they are properly part of the normal employee-management communications and should be promptly routed to the appropriate official concerned.] Similarly, ideas to improve working conditions which could and should have been corrected through normal or customary action by the employee or supervisor are not suggestions within the scope of the suggestion program. Suggestions such as these and suggestions submitted which are trivial in nature or which would obviously cost more to process than any saving they could achieve will not be evaluated under the suggestion program but will be returned to the appropriate supervisor for oral acknowledgment.

- b. A suggestion made by an employee, but not adopted when made, shall remain active for period of two years. Adoption of suggestion within two-year period after it is submitted will entitle original suggester to reconsideration for appropriate award. Suggestion becomes void if not adopted within two years.
- c. If two or more employees independently submit identical suggestions simultaneously, any award granted will be divided among employees making the suggestion.
- d. No employee's annual salary rate shall be affected by any award granted under this program.
- e. Federal withholding tax will be deducted from all awards prior to payment.

[f.] Determining amount of awards (In interest of uniformity, this determination will be made by the Bureau and division heads should not recommend a specific amount.)

(1) Where tangible benefits are involved

Cash awards of this type result from suggestions, inventions, or other performance involving monetary savings of [\$250] or more. Such awards are based on the estimated savings for the first year employee's contribution is in operation and may range from [\$25 to \$1,000 with the approval of the Director, to \$5,000 with the approval of the Department, or in excess of \$5,000 to a maximum of \$25,000 with the approval of the CSC.] The following table is used in determining the amount of award.

SECTION 14. SERVICES AVAILABLE TO EMPLOYEES

(a) Table - award scale for tangible savings

<u>Savings</u>	<u>Amount of award</u>
[\$250 - \$1,000	\$25 for the first \$250 in benefits and \$5 for each additional \$50 or fraction thereof
\$1,001 - \$10,000	\$100 for the first \$1,000 in benefits and \$5 for each additional \$100 or fraction thereof
\$10,001 - \$20,000	\$550 for the first \$10,000 in benefits and \$5 for each additional \$200 or fraction thereof.
\$20,001 - \$100,000	\$800 for the first \$20,000 in benefits and \$5 for each additional \$1,000 or fraction thereof
\$100,001 - or more	\$1,200 for the first \$100,000 in benefits and \$5 for each additional \$5,000 or fraction thereof]

(2) Where intangible benefits are involved

Such awards may vary from[\$25]to \$5,000,[subject to the same approval as set forth under tangible benefits,]and apply to all types of performance other than that involving monetary savings. Awards as high as \$25,000 may be granted with the approval of the CSC. The amount of an award for intangible benefits is determined by the value of the employee's contribution and its application to the Bureau's work. The minimum award of[\$25]will not be granted unless the contribution compares favorably with those receiving the minimum award for tangible benefits. In instances involving personal danger or risk,[the degree of such personal danger or risk will be considered, along with the value of the employee's contribution, in determining the amount of the award. The table set out below in item 4d is used in determining the amount of such awards.]

[g.] Group awards

Contributions made by a group of two or more employees, with all members of the group contributing, including supervisors, may be rewarded by a group cash award to be shared equally among the group or with each member being rewarded in proportion to his contribution. The total of such a group award will normally be the amount authorized for that type award if made to one individual. Any exceptions recommended should be fully documented with an explanation as to why the general rule should not be followed. Groups may also receive honorary awards if the facts so justify.

[4. Special achievement awards

a. Basis

For sustained high level performance, major duties of the position must be performed for a period of at least six months in a manner clearly exceeding normal requirements, or performed in a highly satisfactory manner for such a period characterized by abnormal work load, temporary shortage of personnel, or other unusual circumstances. Awards for sustained high level performance should not have been granted within the six months preceding the date of nomination. When other awards can be justified, awards based on superior performance should not be granted on a repetitive basis.

SECTION 14. SERVICES AVAILABLE TO EMPLOYEES

b. Scale for sustained above-average performance

General Schedule (GS) Grade	Special achievement award plus rating above satisfactory	
	Alone	
1 - 4	\$100	\$150
5 - 8	\$150	\$200
9 - 11	\$200	\$250
12 - 13	\$250	\$300
14 - 18	\$300	\$350

c. Criteria for awards to employees for specific acts or service are:

- (1) Performance which has involved overcoming unusual difficulties
- (2) Creative efforts that make important contributions to science or research, or otherwise increased efficiency or improved service
- (3) Performance of assigned duties with special effort or special innovation that results in significant economies or other highly desirable benefits
- (4) Performance of assigned tasks so that one or more important job requirements are significantly exceeded
- (5) Exemplary or courageous handling of an emergency situation related to official employment

d. Scale for one-time achievements or nonrecurring performance

Value of benefit	Extent of application			
	Limited	Extended	Broad	General
Moderate	\$ 25 - 50	\$ 50 - 100	\$ 100 - 200	\$ 200 - 400
Substantial	\$ 50 - 100	\$100 - 200	\$ 200 - 400	\$ 400 - 1000
High	\$100 - 200	\$200 - 400	\$ 400 - 1000	\$1000 - 2500
Exceptional	\$200 - 400	\$400 - 1000	\$1000 - 2500	\$2500 - 5000

For purposes of uniform administration, intangible awards for nonrecurring achievements will be as follows: clerks in GS-4 and less - \$100; other non-Agent employees - \$150; and Agent personnel - \$200.

5. Noncash awards

a. Honorary awards - may be granted under this plan in recognition of:

(1) meritorious personal or group contributions or achievements; (2) special acts in the public interest; (3) distinguished or exceptional service to this Bureau; or (4) length of service. Ten years or more of satisfactory service to this Bureau shall be considered sufficient to justify an honorary award based on length of service. However, Federal length of service pins are also available. Honorary recognition of employee contributions may be independent of or in addition to cash awards and may take the form of emblems, pins, keys, scrolls, certificates, or other similar recognition, such as commendation or appreciation letters.

b. Service awards

- (1) Service award keys are presented to Bureau employees upon completion of 10, 20, 25, and 30 years of active service in the Bureau. Employees serving 35 years of active service are presented with specially prepared scrolls. After completing 40 years of service, a special plaque is presented. Special awards are

PART I

SECTION 14. SERVICES AVAILABLE TO EMPLOYEES

also given on the 45th and 50th anniversaries. Effective on and after 7-1-71 employees voluntarily retiring after 30 years or more in the FBI may request a Thirty-Year Plaque. [Effective 6-5-72 this benefit was extended to provide appropriate plaques, on request, for employees with 20 or more years service.] Such requests must be made on a timely basis.

- (2) In computing the service time of employees for service award matters, leave without pay in excess of three months is deducted. The first 90 days of leave without pay in each single instance is disregarded. Military leave without pay, as well as any period of separation from the Bureau's rolls, is deducted.
- (3) If an employee loses his service award key, a duplicate key may be ordered by contacting the Personnel Section of the Administrative Division. It will be necessary for the employee to pay for the cost of a duplicate service award key. The answers to any questions concerning service award matters can be obtained by contacting the Personnel Section.
- (4) In all cases in which a Bureau employee is to receive a service award on his 20th or subsequent anniversary, the SAC should make a personal presentation of such service award if it is not possible for the Director to make such presentation personally on the anniversary date. The Director's personal interest in these awards should be specifically told to the employee at the time of the presentation, together with the fact that he would desire to make such presentation personally if the occasion permitted. During the course of an inspection, the inspector, as the Director's personal representative, is to present service award letters.
- (5) Federal length of service awards
Federal length of service emblems will be granted certain employees upon completion of 15 and 30 years' total Government service. To qualify, employee must (1) have completed at least ten years of civilian and/or military service, exclusive of FBI service; and (2) have completed at least one year of service with the FBI. Such emblems will be granted only upon specific request of an employee and such requests should be accompanied by a listing of Government service employee considers qualifying.

c. Commendations

Recommendations for letters of commendation from the Director should be made only when recommending official is convinced that certain elements of an employee's performance rise above normal reasonable expectations sufficient to warrant special recognition. In all cases facts, not conclusions, which can stand on their own merits as justification must be submitted. Submission should not exceed two pages in length and if submitted with recommendation for incentive award (FD-255), memorandum recommending commendation may serve as transmittal memorandum for incentive award recommendation. Forward in duplicate, retaining one copy in field office personnel file, none for individual personnel files.

d. Awards to private citizens

Agency heads are authorized to recognize private citizens who have made contributions to the agency's mission or who have contributed to improvements of the operating efficiency and economy of our Government.

6. Forms for recommending incentive awards

a. Suggestions

May be submitted on regular suggestion form, FD-252. (See item 3a, above, for number of copies.)

SECTION 14. SERVICES AVAILABLE TO EMPLOYEES

- b. All other types of performance
Except for quality-salary increase recommendations, which are submitted incident to annual performance ratings, submit on FD-255 forwarding to the Bureau original and one copy for each employee named, retaining one copy in field office personnel file, none for individual personnel files. Length should be confined to two pages or less.
7. How to recommend awards
 - a. Use proper form (FD-252 if suggestion or FD-255 for other performance).
 - b. Carefully follow instructions on forms.
 - c. Submit information to Bureau in clear, concise language.
 - d. Where award is based on sustained, above-average performance, summarize highlights in FD-255 in two or three paragraphs, submitting only sufficient information to clearly show the superior nature of employee's performance.
 - e. Be specific. Give facts, not conclusions. Use factual examples when pertinent.
 - f. Clerical and Agent supervisors may submit FD-255 to their divisional heads recommending awards for employees under their supervision in which case the divisional head may then submit the form to the Bureau with a brief cover letter stating he concurs in the recommendation of the supervisor. Divisional heads may also submit form FD-255 as a letter to the Director in which case no cover letter is necessary.
8. Recognition of awards
Incentive awards granted employees are to be mentioned in performance ratings and must be considered in qualifying and selecting employees for promotion. Such consideration is specifically required in the Government Employees' Incentive Awards Act.
9. Presentation of awards
Award letters must be presented by SAC or division head when not personally presented by the Director. Should SAC or division head be unavailable, person acting in his behalf may make presentation. During the course of an inspection, the inspector, as the Director's personal representative, is to present incentive award letters and quality salary increase letters.
10. Stimulating employee participation
All Bureau employees must be kept fully advised of this program and encouraged to participate on a continuing basis. Information should include the various types of awards and eligibility requirements. This program is an essential subject for discussion at least once yearly before groups of employees attending conferences, schools, etc. The efforts of supervisors in successfully motivating the interest and participation of their employees in this program will be given proper recognition. Employee participation will be a factor in determining employee's suitability for advancement. Appropriate inquiries will be made during inspections concerning the extent to which the program is being used. All recommendations pertaining to recognition and awards must be given prompt attention.

8/5/75 Request

IV - A - 1

274-10/28

SECRET

- 1 - Mr
- 1 - Mr
- 1 - Mr
- 1 - Mr
- 1 - Mr

- Mr. Tolson _____
- Mr. Sullivan _____
- Mr. Mohr _____
- Mr. Bishop _____
- Mr. Brennan, C.D. _____
- Mr. Callahan _____
- Mr. Casper _____
- Mr. Conrad _____
- Mr. Felt _____
- Mr. Gale _____
- Mr. Rosen _____
- Mr. Tavel _____
- Mr. Walters _____
- Mr. Soyars _____
- Tele. Room _____
- Miss Holmes _____
- Miss Gandy _____

September 23, 1970

O
Foreign General
BY LIAISON

Honorable H. R. Haldeman
Assistant to the President
The White House
Washington, D. C.

Dear Mr. Haldeman:

By letter dated September 21, 1970, addressed to the President, I outlined the manner in which this Bureau might expand its coverage abroad in an effort to produce intelligence information of a high quality.

After giving further consideration to this matter, I would like to advise you that it is my feeling that the opening of an FBI liaison office in Beirut, Lebanon, would place us in an area where we might be able to develop intelligence data relating particularly to the Middle East situation. Accordingly, with the President's approval, I will establish a liaison office in Beirut.

Sincerely yours,

WRW:ams
(8)

ams

REC-153

67-539244-297

Re B

NOTE: See cover memorandum Sullivan to Mr. Tolson 9/22/70, 970
"Expansion of FBI Foreign Intelligence Collection Efforts." WCS:csh 46

Classified "Secret" to protect sensitive Bureau operations abroad.

NATIONAL SECURITY INFORMATION

- Tolson _____
- Mohr _____
- Bishop _____
- Brennan, C.D. _____
- Callahan _____
- Casper _____
- Conrad _____
- Felt _____
- Gale _____
- Rosen _____
- Tavel _____
- Walters _____
- Soyars _____
- Tele. Room _____
- Holmes _____
- Gandy _____

Unauthorized Disclosure
Subject to Criminal Sanctions

SECRET
Group 1

Classified by 6283
Exempt from GDS Category 3
Date of Declassification Indefinite

Excluded from automatic
downgrading and
declassification

19 SEP 24 1970

PERS. REC. UNIT

MAIL ROOM TELETYPE UNIT

UNITED STATES GOVERNMENT

Memorandum

- Tolson _____
- Sullivan _____
- Mohr _____
- Bishop _____
- Brennan, C.D.
- Callahan _____
- Casper _____
- Conrad _____
- Felt _____
- Gale _____
- Rosen _____
- Tavel _____
- Walters _____
- Soyars _____
- Tele. Room _____
- Holmes _____
- Gandy _____

TO : Mr. W. C. Sullivan *SW*

SECRET DATE: 9-22-70

FROM : C. D. Brennan

SUBJECT: EXPANSION OF FBI FOREIGN *COVERAGE*
INTELLIGENCE COLLECTION EFFORTS

Based on my memorandum 9-21-70, the Director approved instructing all Legats to expand their current coverage and to advise of their plans and recommendations for accomplishing this. We have prepared a cablegram to all Legats, informing them of our proposal for expansion, advising them of the President's need for more intelligence information of a high quality and instructing them to increase their coverage in order to secure this. We ask for cable response within 24 hours with plans and recommendations for accomplishing our objectives.

ACTION:

Attached for approval is the cablegram to all Legats discussed above.

Enclosure - Sent 9-23-70

- 1 - Mr. W. C. Sullivan *wpl*
- 1 - Mr. J. P. Mohr
- 1 - Mr. T. E. Bishop
- 1 - Mr. N. P. Callahan
- 1 - Mr. W. M. Felt
- 1 - Mr. C. D. Brennan
- 1 - Mr. D. E. Moore
- 1 - Mr. W. R. Wannall
- 1 - Mr. G. A. Day
- 1 - Foreign Liaison Desk

GAD:plm
(11)

"O.K. Expedite in every way. Begin selection now for such assignments so Tolson may pass upon them. H"

5 JUN 23 1971

occc
WEL
OK. Expedite in every way. Begin selection now for such assignments so Tolson may pass upon them.

539244-27

OCT 8 1970

COPI REMOVED BY SRD TOLSON

SECRET

Classified by 6289
Exempt from GDS, Category 3
Date of Declassification Indefinite

PLER. REC.

5-3

SECRET

- 1 - W. C. Sullivan
- 1 - J. P. Mohr
- 1 - Mr. T. E. Bishop
- 1 - Mr. N. P. Callahan
- 1 - Mr. W. M. Felt

23
9-22-70

CODE

CABLEGRAM

URGENT

TO ALL LEGATS

- 1 - Mr. C. D. Brennan
- 1 - Mr. D. E. Moore
- 1 - Mr. W. R. Wannall
- 1 - Mr. G. A. Day
- 1 - Foreign Liaison Desk

FROM DIRECTOR FBI

EXPANSION OF FBI FOREIGN INTELLIGENCE COLLECTION EFFORTS.

AS, RESULT OF DISCUSSION WITH THE PRESIDENT, I AM INSTRUCTING EACH LEGAT TO CONSIDER AND MAKE IMMEDIATE PLANS FOR THE COLLECTION OF POLITICAL INTELLIGENCE ABROAD. IN AN EFFORT TO SATISFY THE PRESIDENT'S NEED FOR MORE INTELLIGENCE INFORMATION OF A HIGH QUALITY, I PROPOSE TO ADD ONE AGENT TO PARIS, BONN, AND ROME, AND TWO AGENTS TO BUENOS AIRES, AS WELL AS OPENING NEW OFFICES IN TEL AVIV, SAIGON, CARACAS, SAN JOSE, LA PAZ, AND HELSINKI. PARIS SHOULD STEP UP ITS COVERAGE IN BELGIUM AND FRANCE. BONN SHOULD TAKE OVER COVERAGE IN AUSTRIA AND CONTINUE HANDLING NETHERLANDS. ROME WILL RE-ESTABLISH MEDITERRANEAN ROAD TRIP COVERING TURKEY AND CYPRUS. BUENOS AIRES WILL ADD PARAGUAY TO ITS TERRITORY AND SHOULD MAKE PLANS FOR COVERAGE OF CHILE, POSSIBLY THROUGH ARGENTINIAN SOURCES. TEL AVIV WILL

BE EXPECTED TO SERVE AS LISTENING POST FOR MIDDLE EAST EXCEPT TURKEY. SAIGON WILL HANDLE VIETNAM WHILE HONG KONG WILL CONTINUE SOUTHEAST ASIA ROAD TRIP. CARACAS WILL HANDLE ECUADOR,

GAD:plm
(12)

NATIONAL SECURITY INFORMATION
Unauthorized Disclosure
Subject to Criminal Sanctions

- Tolson _____
- Sullivan _____
- Mohr _____
- Bishop _____
- Brennan, C.D. _____
- Callahan _____
- Casper _____
- Conrad _____
- Felt _____
- Gale _____
- Rosen _____
- Tavel _____
- Walters _____
- Soyars _____
- Tele. Room _____
- Holmes _____
- Gandy _____

REMOVED BY SMD

VIA TELETYPE
ENCIPHERED
SEE NOTE PAGE TWO
Classified by 6283
Exempt from GDS, Category 3
Date of Declassification Indefinite

SECRET

CABLEGRAM TO ALL LEGATS
RE: EXPANSION OF FBI FOREIGN INTELLIGENCE
COLLECTION EFFORTS

COLOMBIA, GUYANA, SURINAM, FRENCH GUIANA, PANAMA, AND ISLANDS
ADJACENT TO VENEZUELA. SAN JOSE WILL COVER ALL CENTRAL AMERICA
EXCEPT PANAMA, LA PAZ WILL PLAN COVERAGE OF PERU, AND HELSINKI
WILL COVER ALL SCANDANAVIAN COUNTRIES.

EACH LEGAT SHOULD CONSIDER EFFECT OF ABOVE PROPOSALS ON
HIS OWN TERRITORY AND RESPONSIBILITIES AND SUCAB WITHIN TWENTY-FOUR
HOURS WITH COMMENTS AND PLANS FOR SECURING THE INFORMATION THE
PRESIDENT DESIRES. IT IS FULLY RECOGNIZED FOREIGN INTELLIGENCE
COLLECTION IS WITHIN CENTRAL INTELLIGENCE AGENCY JURISDICTION,
BUT THE CRITICAL INTERNATIONAL SITUATION DEMANDS THAT THE
PRESIDENT HAVE PROMPT, ACCURATE, AND INFORMATIVE INTELLIGENCE
UPON WHICH TO BASE DECISIONS AFFECTING SECURITY OF THIS COUNTRY.
SITUATION VARIES FROM ONE COUNTRY TO ANOTHER, AND LEGAT IN
SWITZERLAND, FOR EXAMPLE, MAY NOT BE ABLE TO ESTABLISH THE
SAME DEPTH OF COVERAGE POSSIBLE IN MEXICO. NEVERTHELESS, EACH
LEGAT IS EXPECTED TO CONTRIBUTE TO OUR EFFORTS IN THIS NEW FIELD.
THERE IS TO BE NO DISCUSSION OF ABOVE MATTERS OUTSIDE YOUR OFFICE
NOTE: UNDER ANY CIRCUMSTANCES WITHOUT SPECIFIC APPROVAL.

See memorandum C. D. Brennan to W. C. Sullivan dated 9-22-70,
captioned as above, prepared by GAD:plm

UNITED STATES GOVERNMENT

Memorandum

SECRET

Tolson	_____
Sullivan	_____
Mohr	_____
Bishop	_____
Brennan, C.D.	_____
Callahan	_____
Casper	_____
Conrad	_____
Felt	_____
Gale	_____
Rosen	_____
Tavel	_____
Walters	_____
Soyars	_____
Tele. Room	_____
Holmes	_____
Gandy	_____

TO : MR. TOLSON

DATE: 9/25/70

FROM : W. C. Sullivan *WCS*

cc Mr. Sullivan
Mr. Mohr
Mr. Brennan

SUBJECT: EXPANSION OF FBI FOREIGN COVERAGE

GENERAL

Walters
Felt

Late yesterday I received a call from Major General Alexander Haig, Advisor to the President on Foreign Affairs, in the office of Dr. Henry Kissinger. He said that he was with the President at the time the conversation took place with the Director, relative to opening some new FBI liaison offices and adding men to some of those already in existence. He said he thought it was an excellent idea and just wanted to pass on to the Bureau his own reaction. He said Dr. Kissinger certainly shares this same viewpoint.

General Haig went on to explain that this country needs more high-quality intelligence and a greater knowledge, in depth, of what is going on in the troubled areas of the world. He inquired where some of our new offices might be. I did not want to be definitive on the matter, but pointed out that the Director was giving consideration to opening some offices where, as he indicated, there was trouble, and where it was important for the United States to have high-quality information relative thereto. I said the Director was therefore considering countries like Israel, Venezuela, Lebanon, Finland, Bolivia, and the addition of some men in other offices, such as Buenos Aires.

General Haig said this is good, and he added that he thought it especially important for us to open offices in Israel, Lebanon and Finland. He said that he will be out of the country for awhile and I wished him a safe trip and this terminated the conversation.

ACTION -
For the information of the Director.

539244-311
10 OCT 13 1970 46

WCS:CSH (4)

WCS

Classified by 6283
Exempt from GDS, Category 3
Date of Declassification Indefinite

~~OCT 8 1970~~

5 JUN 71

SECRET

NAT. INT. SEC.
RECORDS UNIT
Walters

REMOVED BY SRD
11 OCT 21 1971

NATIONAL SECURITY INFORMATION
Unauthorized Disclosure
Subject to Criminal Sanctions

SECRET

C O P Y

4:22 PM

October 15, 1970

MEMORANDUM FOR MR. TOLSON
MR. SULLIVAN
MR. MOHR
MR. C. D. BRENNAN
MR. CALLAHAN
MR. BISHOP

While talking to Honorable H.R. Haldeman, Assistant to the President, I mentioned that we have never heard anything from that expansion of our foreign service--the matter that had been turned over to him. Mr. Haldeman said he knew and that is one he is still working on and has to get nailed down.

I told him I would imagine he will have difficulty on that and Mr. Haldeman said he already has. I said knowing the State Department, they have always had a suspicion, which is not true, that in these places where we have our men stationed that we are looking over their shoulder, which we do not do. I said I have instructed our people never to get involved in office politics and never to have too close contact socially with the Embassy personnel. I said I think they have some suspicion that we are kind of a watchdog on their carryings on in the Embassy, which is unfounded, and I think the expansion probably gives them a little more fear along that line. Mr. Haldeman said he will see what he can do, and I said that if I can be of any further help, to let me know.

Very truly yours,

John Edgar Hoover
Director

NATIONAL SECURITY INFORMATION

Unauthorized Disclosure

Subject to Criminal Sanctions

Classified by 6283
Exempt from GDS, Category 3
Date of Declassification Indefinite

JEH:edm (10)

SECRET

SECRET

4:22 PM

October 15, 1970

Foreign General

MEMORANDUM FOR MR. TOLSON
MR. SULLIVAN
MR. MOHR
MR. C. D. BRENNAN
MR. CALLAHAN
MR. BISHOP

While talking to Honorable H. R. Haldeman, Assistant to the President, I mentioned that we have never heard anything from that expansion of our foreign service -- the matter that had been turned over to him. Mr. Haldeman said he knew and that is one he is still working on and has to get nailed down.

I told him I would imagine he will have difficulty on that and Mr. Haldeman said he already has. I said knowing the State Department, they have always had a suspicion, which is not true, that in those places where we have our men stationed that we are looking over their shoulder, which we do not do. I said I have instructed our people never to get involved in office politics and never to have too close contact socially with the Embassy personnel. I said I think they have some suspicion that we are kind of a watchdog on their carryings on in the Embassy, which is unfounded, and I think the expansion probably gives them a little more fear along that line. Mr. Haldeman said he will see what he can do, and I said that if I can be of any further help, to let me know.

Very truly yours,
J. E. H.

REC-131

John Edgar Hoover
Director

97539244-318
10 OCT 20 1970

NATIONAL SECURITY INFORMATION
Unauthorized Disclosure
Subject to Criminal Sanctions

- Tolson _____
- Sullivan _____
- Mohr _____
- Bishop _____
- Brennan, C.D. _____
- Callahan _____
- Casper _____
- Conrad _____
- Felt _____
- Gale _____
- Rosen _____
- Tavel _____
- Walters _____
- Soyars _____
- Tele. Room _____
- Holmes _____
- Gandy _____

JEH:edm (10)

307 28 110

140

SECRET

Classified by 6283
Exempt from GDS, Category 3
Date of Declassification Indefinite
TIME 4:30
DATE 10-16-70
BY 613

MAIL ROOM TELETYPE UNIT

Foreign General

November 16, 1970

SECRET

MEMORANDUM FOR MR. TOLSON
MR. SULLIVAN
MR. C. D. BRENNAN

On November 10, 1970, Dr. Henry A. Kissinger, accompanied by General Faig, called at my office. Dr. Kissinger wanted to express his personal appreciation for the very valuable material which the Bureau had been supplying to him for the last two years. He stated that without it, it would have been very doubtful that he could have effectively performed his functions as he has been able to do.

Dr. Kissinger stated that the President had inquired of him as to what the status was as to the expansion of our foreign intelligence coverage.

I told Dr. Kissinger that in September the President had suggested to me that we should expand our foreign intelligence operations in order to obtain better quality of intelligence coverage in foreign areas and that I had in September, following the President's request, personally presented a letter to the President upon this proposed expansion and that, subsequently, on September 23, 1970, I had written a letter to Mr. Haldeman adding Beirut, Lebanon, as one of the new offices to be opened where a Legal Attache would be stationed.

I informed Dr. Kissinger that the President in my presence had handed to Mr. Haldeman my letter of September 21st and had instructed Mr. Haldeman to take it up direct with the Secretary of State and not down the line. The President was most insistent at that time that the expansion be effected promptly.

I told Dr. Kissinger that I had heard nothing further about this matter until three weeks ago when in conference with the Attorney General I mentioned to him the fact that so far as I knew, no action had been taken upon the President's instructions as to the expansion of our foreign intelligence. I advised Dr. Kissinger that the Attorney General indicated that there had been some complications and that he, the Attorney General, was going to confer with Mr. Haldeman shortly about this situation. I advised Dr. Kissinger

NATIONAL SECURITY INFORMATION
Unauthorized Disclosure
Subject to Criminal Sanctions

- Tolson _____
- Sullivan _____
- Mohr _____
- Bishop _____
- Brennan, C.D. _____
- Callahan _____
- Casper _____
- Conrad _____
- Felt _____
- Gale _____
- Rosen _____
- Tavel _____
- Walters _____
- Soyars _____
- Tele. Room _____
- Holmes _____

JEH:EDM (7)

REMOVED BY SRD

SECRET

SENT FROM D. O.
 Classified by 6283/111
 Exempt from GDS, Category 3
 Date of Declassification Indefinite
 BY _____

SECRET

Memorandum for Messrs. Tolson, Sullivan, C. D. Brennan

November 16, 1970

that I had heard nothing further from the Attorney General nor Mr. Haldeman and that the situation is the same as it was on September 21st when I submitted my recommendations to the President.

I gave to Dr. Kissinger a copy of my letter which I personally presented to the President under date of September 21, 1970, together with a copy of my letter of September 23rd to Mr. Haldeman, in order to complete Dr. Kissinger's file.

Dr. Kissinger indicated that he would take this matter up very promptly with the President as it was the desire of the President that such implementation be promptly effected and that the delay since September should not have taken place.

Until I receive word from either Dr. Kissinger or Mr. Haldeman as to what the status is in this matter, we will take no action toward implementing our foreign intelligence coverage.

Very truly yours,

J. E. H.

John Edgar Hoover
Director

SECRET

Police UNIT

SECRET

February 9, 1971

Assistant Attorney General
for Administration

Director, FBI

LEGAL ATTACHES
EXPANSION OF FOREIGN COVERAGE
EMPLOYEES AND NEW OFFICES

Foreign General

At the specific request of the President and with the approval of the Department of State, this Bureau has increased the number of employees stationed abroad to a total of 88. There is attached a tabulation setting forth the revised number of employees by countries.

The Office of Management and Budget should be advised of these figures with the information that the expansion was made at the specific request of the President and with the verbal approval of the Secretary of State William P. Rogers. The requested expansion was confirmed by letter dated November 23, 1970, to Honorable William B. Macomber, Jr., Deputy Under Secretary for Administration, Department of State, and a copy of this letter is attached in response to a verbal request from Mr. John J. Kaminski, Director, Office of Budget and Accounts, Department of Justice. However, subsequent to the transmission of this letter, it was decided not to open a Legal Attache office in Viet Nam, the proposed assignment for Costa Rica was changed to Nicaragua, and the staff at Mexico was reduced by one employee.

NATIONAL SECURITY INFORMATION
Unauthorized Disclosure
Subject to Criminal Sanctions

REC-135

539244-359

1071 72

MAILED 12
FEB - 9 1971
COMM-FBI

[Handwritten signatures and initials]

ENCLOSURE

Enclosures (2)

WCJ:dls

(11)

Classified by 6283
Exempt from GDS, Category 3
Date of Declassification Indefinite

FEB 10 1971

SECRET

- Tolson _____
- Sullivan _____
- Mohr _____
- Bishop _____
- Brennan, C.D. _____
- Callahan _____
- Casper _____
- Conrad _____
- Dalbey _____
- Felt _____
- Gale _____
- Rosen _____
- Tavel _____
- Walters _____
- Soyars _____
- Tele. Room _____
- Holmes _____

SECRET

FBI Personnel Stationed Abroad

<u>Country</u>	<u>Total Employees</u>
Argentina	6
Bolivia	2
Canada	5
Denmark	4
France	6
Germany	7
Hong Kong	4
Israel	4
Italy	4
Japan	4
Lebanon	2
Mexico	23
Nicaragua	4
Spain	2
Switzerland	2
United Kingdom	5
Venezuela	<u>4</u>
Total	88

SECRET

2/9/71

67-539244-359

ENCLOSURE

8/5/75
request

III - G

GUIDE TO INDEXING

RULES PERTAINING TO THE GENERAL INDEX

RETAIN

274-10128

62-116395-547

43
27
encl

TJM:lhb 8/18/75

The Attorney General U.S. SENATE SELECT COMMITTEE
ON INTELLIGENCE ACTIVIS (SSC)

Re 8/5/75 superseding req for specified FBI materials, which req was rec'd on that date from the SSC. Enclsd is memo for forwarding to the Committee which responds to reqs identifd in abov communicatn as Roman numeral III., Part D., Item 8., & Roman numeral IV., Part A., Items 1. through 4. Also enclsd for ur records is cc of above memo prepared for the Committee.

274-10128

GUIDE TO INDEXING

These instructions are to serve only as a very general guide in the selection of indexing and good judgment should be used in their application.

The original complainants and writers of outside source mail are indexed except when they are furnishing information in line of duty or in official capacity because of their status as law enforcement or Government officials.

Although, as indicated in Bureau Bulletin #53-15, 6/25/53, it is unnecessary to read beyond the synopsis of investigative reports in any criminal classifications, if you find indication of subversive information you should read the details.

If names are indexed in the synopsis, read the details to bring up localities and indentifying data.

Additional indexing will be done when indicated by green pencil by Supervisor.

(1) TRAINING SCHOOLS AND NATIONAL ACADEMY MATTERS

Training of Bureau Personnel
Circle subject (the school)

National Academy
Circle subject (applicant or the department)
Index applicant if placed in department file

Police Training Schools
Circle subject
Index officers if regarding commendation or criticism

Special Files Pertaining to Training Program
Circle subject
Index writer of outside source mail
Index titles of films
Index outside lecturers or instructors

(2) NEUTRALITY MATTERS

Circle subject (firm, individual, or organization)
Index relatives of subjects
Index members of organizations or firms involved
Index names of foreigners and foreign firms with which subjects are dealing
Index results of mail covers
Index results of technical surveillances
Index writer of outside source mail
Index original complainant
Index informants who are identified as members

(3) OVERTHROW OR DESTRUCTION OF GOVERNMENT

Circle subject (individual or organization)
Index relatives of subject
Index subversive organizations when information is given
Index subversive individuals
Index results of mail covers
Index results of technical surveillances
Index writer of outside source mail
Index original complainant
Index temporary (T) informants who are indentified as members or former members of the Communist Party or any subversive organization

(4) FEDERAL FIREARMS ACT; NATIONAL FIREARMS ACT

Circle subject
Index writer of outside source mail
Index original complainant
(It is unnecessary to read or index Investigative Reports beyond the synopsis in this classification)

(5) INCOME TAX - The Bureau does not have investigative jurisdiction over Income Tax Matters and main files would not be opened unless the Bureau made a special investigation.

Circle subject (Income Tax - General)
Index violators
Index writer of outside source mail
Index original complainant

(6) INTERSTATE TRANSPORTATION OF STRIKE BREAKERS

Circle subject (individual, union, company or organization)
Index strike breakers
Index suspects
Index writer of outside source mail
Index original complainant
(It is unnecessary to read and index Investigative Reports beyond the synopsis in this classification)

(7) KIDNAPING

Circle subject
Circle victim if carried in caption
Circle persons passing, possessing or disposing of any ransom money or other property delivered as ransom
Index suspects
Index writer of outside source mail
Index original complainant
(It is unnecessary to read and index Investigative Reports beyond the synopsis in this classification)

(8) MIGRATORY BOMB ACT

Circle subjects

Index suspects

Index writer of outside source mail

Index original complainant

(It is unnecessary to read and index Investigative Reports beyond the synopsis in this classification)

(9) EXTORTION

Circle subject

Circle victim if carried in caption

Circle persons passing, possessing or disposing of any extortion money

Index suspects

Index writer of outside source mail

Index original complainant

(It is unnecessary to read and index Investigative Reports beyond the synopsis in this classification)

(10) RED CROSS ACT

Circle subject (individual, company, or organization)

Index suspects

Index writer of outside source mail

Index original complainant

(It is unnecessary to read and index Investigative Reports beyond the synopsis in this classification)

(11) TAX (OTHER THAN INCOME) - The Bureau does not have investigative jurisdiction over Tax Matters and main files would not be opened unless the Bureau made a special investigation.

Circle subject (°Tax Other than Income)

Index violators

Index suspects

Index writer of outside source mail

Index original complainant

(12) NARCOTICS ACT - The Bureau does not have investigative jurisdiction over the Narcotics Act and main files would not be opened unless the Bureau made a special investigation.

Circle subject (°Narcotics Act)

Index violators

Index suspects

Index writer of outside source mail

Index original complainant

(14) (S) SEDITION (SED.)

- Circle subject (individual or organization)
- Index relatives of subject
- Index any organization printing seditious leaflets
- Index results of mail covers
- Index results of technical surveillances
- Index subversive individuals
- Index temporary (T) informants who are identified as members or former members of the Communist Party or any other subversive organization
- Index writer of outside source mail
- Index original complainant

(15) (C) THEFT FROM INTERSTATE SHIPMENT (T.F.I.S.)

- Circle subject
- If the subject is unknown, circle the carrier
- If the subject is unknown and the carrier is not given, circle the consignee and the consignor
- If the subject is known, it is unnecessary to circle or cross index the carrier, consignee or consignor
- If the subject is unknown, underscore all identifying data, such as information as to type of case (theft of cigarettes, liquor, clothing, etc.,) date activity took place, location (city and state), and any other information that would aid in identifying the case
- Circle the victim if carried in caption in cases involving thefts from passengers traveling interstate
- Index suspects
- Index fences
- Index writer of outside source mail
- Index original complainant
- (Do not index results of technical surveillances
(It is unnecessary to read or index Investigative Reports beyond the synopsis in this classification)

(17) (C) VETERANS ADMINISTRATION MATTERS (V.A.M.)

- Circle subject
- Index suspects
- Index writer of outside source mail
- Index original complainant
(It is unnecessary to read or index Investigative Reports beyond the synopsis in this classification)

(18) (C) MAY ACT

- Circle subject (Prostitute, procurer or manager)
- Index soldiers and civilians involved
- Index suspects
- Index writer of outside source mail
- Index original complainant
- (Do not index results of mail covers. Index individual on whom mail cover is placed.
(It is unnecessary to read or index Investigative Reports beyond the synopsis in this classification)

(C) - CRIMINAL
(S) - SUBVERSIVE

BOORUM & PEASE "NGEAR" ©

(21) (C) FOOD AND DRUG ACT - The Bureau does not have investigative Jurisdiction over the Food and Drug Act and main files would not be opened unless the Bureau made a special investigation.

Circle subject (°Food and Drug Act)
Index violators
Index suspects
Index name of food or drug involved
Index writer of outside source mail
Index original complainant

(23) (C) PROHIBITION - The Prohibition Amendment has been repealed but Classification 23 is still used for violations of the Alcohol Tax Laws. Since the Bureau does not have investigative jurisdiction over violations of the Alcohol Tax Laws, main files would not be opened unless the Bureau made a special investigation.

Circle the subject (°Prohibition)
Index suspects
Index violators
Index writer of outside source mail
Index original complainant

(25) (S) SELECTIVE SERVICE ACT (S.S.A.)

Circle subject (individuals, members of boards, or companies)
(Underline Selective Service Number when sending the mail to General Index
Index suspects
Index writer of outside source mail
Index original complainant
(It is unnecessary to read or index Investigative Reports beyond the synopsis in this classification)

(26) (C) INTERSTATE TRANSPORTATION OF STOLEN MOTOR VEHICLE - OR AIRCRAFT (I.T.S.M.V.) (I.T.S.A.)

Circle subject
If subject is unknown or if an alias of unknown subject is not given, circle make of vehicle and underline identification number (if identification number is not given, underline motor number or serial number or any identifying number)
Circle aircraft on the keyword "Airplane"
If the subject is unknown and the motor or serial number of vehicle is not given, circle license and underline the license number
If the subject is unknown and the make of the vehicle and identification number, motor number, serial number or license number is not given, circle the owner
Index suspects
Index vehicles which have been stolen if placing mail in a
Index original complainant
(Do not index results of technical surveillances
(It is unnecessary to read or index Investigative Reports beyond the synopsis in this classification)

(27) (C) PATENT MATTER

Circle subjects (individuals or companies)
Circle victims if carried in caption
Index suspects
Index writer of outside source mail
Index original complainant
(It is unnecessary to read or index Investigative Reports beyond the synopsis in this classification)

(28) (C) COPYRIGHT MATTER

Circle subjects (individuals, companies, or organizations)
Index suspects
Index titles of song sheets or films being bootlegged
Index writer of outside source mail
Index original complainant
(It is unnecessary to read or index Investigative Reports beyond the synopsis in this classification)

(29) (C) BANK FRAUD AND EMBEZZLEMENT (B.F. & E.)

Circle subject
Underline name of bank; city and state where located. If bank does not appear in title of case, underline in synopsis of report
If subject is unknown, circle city and underline state and name of bank and date activity took place (Exception: On Federal Credit Union, circle on the keyword "Federal Credit Union")
Index suspects
Index writer of outside source mail
Index original complainant
(It is unnecessary to read or index Investigative Reports beyond the synopsis in this classification)

(31) (C) WHITE SLAVE TRAFFIC ACT (W.S.T.A.)

Circle subjects
Circle victims if carried in caption
Index suspects
Index madams and procurers
Index writer of outside source mail
Index original complainant
(Do not index results of technical surveillances
(It is unnecessary to read or index Investigative Reports beyond the synopsis in this classification)

(32) (C) IDENTIFICATION MATTERS (FINGERPRINT MATTERS)

(Circle subjects (Most 32's are general files by state or country) OIdent. Matters-underline state or country
OLatent Fingerprints - underline city and state)

(33) (C) UNIFORM CRIME REPORTING OR CRIME STATISTICS

Circle subject matter "Crime Statistics" which has a
sub for different states
(There is seldom anything indexed in this classification)
Index writer of outside source mail requesting information

(35) (C) CIVIL SERVICE ACT - All mail on this act is referred to the
Civil Service Commission and is not handled by the Bureau

(36) (C) MAIL FRAUD (M.F.)

Circle subjects (individuals, companies, or organizations)
Index suspects
Index writer of outside source mail
Index original complainant
(It is unnecessary to read or index Investigative
Reports beyond the synopsis in this classification)

(39) (S) FALSELY CLAIMING CITIZENSHIP; IMMIGRATION AND NATURALIZATION
(F.C.C.)

Individual Cases

Circle subject
Index relatives
Index witnesses to Naturalization
Index writer of outside source mail
Index original complainant

Immigration and Naturalization Name Check Forms

Circle subject (Immigration and Naturalization - 39-0
Index all aliases of applicant or petitioner, including
maiden and married names
It is not necessary to index name of spouse

(40) (S) PASSPORT AND VISA MATTER

Passport and Visa Forms
Circle subject

See Instruction Cards on Visas, Visa Applicants, and Indexing -
Children on Forms for indexing of applicant, relatives,
and persons accompanying applicant.

Index name of applicant for photograph when the photograph is
attached and mail is being classified into a general file.

Passport and Visa Violations

Circle subjects
Index sponsors
Index suspects
Index mail drops
Index writer of outside source mail
Index original complainant

(42) (C) DESERTER; DESERTER - HARBORING

Circle subject
Circle harbinger
Index suspects
Index writer of outside source mail
Index original complainant

(It is unnecessary to read or index Investigative Reports beyond the synopsis in this classification)

(43) (C) ILLEGAL WEARING OF UNIFORM (I.W.U.) (See Classification List for various characters)

Circle subject (individual or company)
Index suspects
Index writer of outside source mail
Index original complainant

(It is unnecessary to read or index Investigative Reports beyond the synopsis in this classification)

(44) (S) CIVIL RIGHTS; CIVIL RIGHTS - ELECTION LAWS; CIVIL RIGHTS - FEDERALLY PROTECTED ACTIVITIES

Circle subjects
Circle victim if carried in caption
When victims or subjects are given in caption do not circle ELECTION LAWS.

Index suspects
Index writer of outside source mail
Index original complainant

(It is unnecessary to read or index Investigative Reports beyond the synopsis in this classification unless subversive or derogatory information is given.)

(45) (C) CRIME ON THE HIGH SEAS (C.H.S.)

Circle subject (Includes stowaways on boats and aircraft)
Circle victim if carried in caption
Circle name of vessel when subject and victim are unknown
Index suspects
Index writer of outside source mail
Index original complainant

(Do not index name of vessel when the subject or victim is known
(It is unnecessary to read or index Investigative Reports beyond the synopsis in this classification)

(46) (C) FRAUD AGAINST THE GOVERNMENT (F.A.G.)

Circle subjects (individuals, companies or organizations)
Index suspects
Index writer of outside source mail
Index original complainant
Index companies if suspected of being involved
In Dependents' Assistance Act of 1950 cases, index service-

/continued/

(46) (C) FRAUD AGAINST THE GOVERNMENT (F.A.G.) /continued/

(It is unnecessary to read or index Investigative Reports beyond the synopsis in this classification)

(47) (C) IMPERSONATION (IMP.)

Circle subject
Index victims
Index suspects
Index writer of outside source mail
Index original complainant

(Do not index results of technical surveillances
(It is unnecessary to read or index Investigative Reports beyond the synopsis in this classification)

(48) (C) POSTAL VIOLATIONS

Circle subject
Index suspects
Index writer of outside source mail
Index original complainant

(It is unnecessary to read or index Investigative Reports beyond the synopsis in this classification)

(49) (C) NATIONAL BANKRUPTCY ACT (N.B.A.)

Circle subject (individuals and companies)
Index suspects
Index writer of outside source mail
Index original complainant

(It is unnecessary to read or index Investigative Reports beyond the synopsis in this classification)

(50) (C) INVOLUNTARY SERVITUDE AND SLAVERY (I.S.S.)

Circle subject (individual, company, or organization)
Circle victim if carried in caption
Index suspects
Index writer of outside source mail
Index original complainant

(It is unnecessary to read or index Investigative Reports beyond the synopsis in this classification)

(51) (S) JURY PANEL INVESTIGATIONS

Circle subject
Circle name of defendant in original case
Index writer of outside source mail
Index jurors when derogatory information is given

BOORUM & PEASE "NOTEPAR" ®

BOORUM & PEASE "NE"

(52) (C) THEFT OF GOVERNMENT PROPERTY (T.G.P.)

Circle subjects
If subjects are unknown, circle the name of the government reservation, boat, company, etc., where the theft occurred and underscore all identifying data, such as information as to type of case (theft of arms, drugs, ammunition etc.), date activity took place, location (city and state), and any other information that would assist in identifying the case.

Index suspects
Index writer of outside source mail
Index original complainant

(Do not index results of mail covers and technical surveillances.
Index individual on whom mail cover is placed.
(It is unnecessary to read or index Investigative Reports beyond the synopsis in this classification)

(54) (S) CUSTOMS LAWS AND SMUGGLING

Circle subject
Index relatives
Index suspects
Index writer of outside source mail
Index original complainant

(55) (C) COUNTERFEITING - The Bureau does not have jurisdiction over Counterfeiting and main files would not be opened unless the Bureau made a special investigation

Circle subject (Counterfeiting)
Index violators
Index suspects
Index writer of outside source mail
Index original complainant

(56) (C) ELECTION LAWS (E.L.)

Circle subjects (individuals or organizations)
When an investigation is conducted of a general election in a state, circle on the key words Election Laws and underline the name of the state. If the investigation pertains to a county election, the county and state are underlined. If the investigation pertains to a city election, the city and state are underlined. Also underline complete phrase which describes the nature of the election law violation.

Index suspects
Index writer of outside source mail
Index original complainant

(It is unnecessary to read or index Investigative Reports beyond the synopsis in this classification)

BOORUM & PEASE "NEIFAR" ®

(58) (C) BRIBERY; CONFLICT OF INTEREST (C.I.)

Circle subjects
Index suspects
Index individual accepting bribe if he cooperates with the
Bureau and has informed the Bureau of the bribe
Index writer of outside source mail
Index original complainant
(It is unnecessary to read or index Investigative
Reports beyond the synopsis in this classification)

(60) (C) ANTI-TRUST

Circle subject (Name of the industry being investigated)
Circle violators (individuals, companies, and associations)
Index suspects
Index writer of outside source mail
Index original complainant
(It is unnecessary to read or index Investigative
Reports beyond the synopsis in this classification)

(61) (S) TREASON

Circle subjects
Index suspects
Index relatives
Index temporary (T) informants who are identified as members
or former members of Communist Party or any subversive
organization
Index writer of outside source mail
Index original complainant

(62) (S) MISCELLANEOUS MATTERS; ADMINISTRATIVE INQUIRY (A.I.)

Circle subject (individuals or general files)
Index suspects
Index writer of outside source mail
Index original complainant

10-1-74

(63) MISCELLANEOUS - NON-SUBVERSIVE

Circle subject (individuals or general files)

Index suspects

Index writer of outside source mail

Index original complainant

(It is unnecessary to read or index Investigative Reports beyond the synopsis in this classification except those on Criminal Rackets Surveys)

(64) FOREIGN MISCELLANEOUS

Circle subject (Individual or organization)

Index suspects

Index relatives if subversive or derogatory information is given

Index results of mail covers if subversive or derogatory information is given

Index results of technical surveillances

Index writer of outside source mail

Index original complainant

(65) ESPIONAGE

Circle subjects (individual, organization, Intelligence Service)

Circle code word

In both known and unknown subject cases, circle companies, firms, corporations, agencies, and defense installations when they are alleged victims or an integral factor in the investigation and underscore location, date activity took place, and any other pertinent information to facilitate location of various categories of cases involving specific companies, firms, etc. This includes such information as loss of documents, theft of plans, etc. If the case involves a document or contract and the number is given, circle "document" or "contract" and underscore the number.

Index suspects

Index relatives

Index references of subversive individuals

Index results of mail covers

Index results of technical surveillances

Index mail drops

Index temporary (T) informants who are identified as members or former members of the Communist Party or any subversive organization

Index writer of outside source mail

Index original complainant

(66) ADMINISTRATIVE MATTERS

Circle subject (general files on administrative procedures)

Index words and phrases that relate to policy matters of the Bureau

(69) (C) CONTEMPT OF COURT (C.O.C.)

Circle subject (Use the original case file, which can be any classification, if the offense has arisen from a case in which we have made an investigation)

Index plaintiff and defendant in original trail

Index suspects

Index writer of outside source mail

Index original complainant

(It is unnecessary to read or index Investigative Reports beyond the synopsis in this classification)

(70) (C) CRIME ON A GOVERNMENT RESERVATION (C.G.R.)
CRIME ON INDIAN RESERVATION (C.I.R.)

Circle subjects

Circle victim if carried in caption

In unknown subject cases involving theft of an automobile, circle the automobile. Unnecessary to circle name of reservation.

In unknown subject cases when it is necessary to circle the name of the government reservation, all identifying data must be underscored, such as information as to type of case (theft of goods, destruction of property, etc.), date activity took place, location (city and state), and any other information to facilitate location of the case.

(Do not index the Government Dept. or Government Reservation except when placing mail in "O" file and you have no subject, victim or automobile to index.

(Dual Character - See Instruction Card "CRIMES ON GOVERNMENT RESERVATIONS"

Index suspects

Index writer of outside source mail

Index original complainant

(It is unnecessary to read or index Investigative Reports beyond the synopsis in this classification)

(71) (C) BILLS OF LADING ACT

Circle subjects (individuals, companies, organizations)

Index suspects

Index writer of outside source mail

Index original complainant

(Do not index results of technical surveillances

(72) (C) OBSTRUCTION OF JUSTICE (O.O.J.); OBSTRUCTION OF COURT ORDER (O.C.O.); OBSTRUCTION OF CRIMINAL INVESTIGATIONS (O.C.I.)

Circle subject (Use the original case file, which can be any classification, if the offense has arisen from a case in

Index suspects

Index writer of outside source mail

Index original complainant

(It is unnecessary to read or index Investigative Reports beyond the synopsis in this classification)

(73) APPLICATION FOR EXECUTIVE CLEMENCY AND APPLICATION FOR PARDON AFTER COMPLETION OF SENTENCE

Circle subject

Index suspects

Index writer of outside source mail

(It is unnecessary to read or index Investigative Reports beyond the synopsis in this classification)

(74) PERJURY

Circle subjects

If a Bureau case, circle subjects of the original violation and use the original case file

Index suspects

Index writer of outside source mail

Index original complainant

(It is unnecessary to read or index Investigative Reports beyond the synopsis in this classification)

(75) BONDSMEN AND SURETIES

Circle subjects (bondsmen)

Index criminals for whom subject may furnish bond

Index suspects

Index writer of outside source mail

Index original complainant

(It is unnecessary to read or index Investigative Reports beyond the synopsis in this classification)

(76) ESCAPED FEDERAL PRISONER; ESCAPE AND RESCUE; PAROLE VIOLATOR; MANDATORY RELEASE VIOLATOR; PROBATION VIOLATOR

Circle subject and anyone aiding prisoner to escape

Index suspects

Index writer of outside source mail

(It is unnecessary to read or index Investigative Reports beyond the synopsis in this classification)

(77) DEPARTMENTAL APPLICANTS (Other than Bureau)

Circle subject

Index relatives if subversive or derogatory information is given on subject or relatives

Index individuals if subversive or derogatory information is given on the individuals

(It is unnecessary to read or index Investigative Reports beyond the synopsis in this classification unless subversive or derogatory information is given)

(78) ILLEGAL USE OF GOVERNMENT TRANSPORTATION REQUESTS

Circle subjects

Index suspects

Index writer of outside source mail

Index original complainant

(79) MISSING PERSONS

Circle subject (missing person)
Index writer of outside source mail
Index original complainant

(80) LABORATORY RESEARCH MATTERS

Circle subjects (general files on research, individuals, and organizations)
Index companies from which we get material
Index individuals contacted regarding research matters
Index words and phrases pertaining to mail placed in general research files
Index writer of outside source mail

(82) WAR RISK INSURANCE AND NATIONAL SERVICE LIFE INSURANCE (OBSOLETE)

(83) COURT OF CLAIMS

Circle subject
Index writer of outside source mail
(It is unnecessary to read or index Investigative Reports beyond the synopsis in this classification)

(84) RECONSTRUCTION FINANCE CORPORATION ACT (OBSOLETE) -
Violations now come in under Classification 46 or 86

(85) HOME OWNERS' LOAN CORPORATION (OBSOLETE) -
Violations are now handled under Classification 29

(86) FEDERAL LENDING AND INSURANCE AGENCIES - The Bureau seldom investigates any of the violations coming under Classification 86 except the Farm Credit Act. Main files would not be opened unless the Bureau made an investigation.

Circle subject
Index suspects
Index writer of outside source mail
Index original complainant
(It is unnecessary to read or index Investigative Reports beyond the synopsis in this classification)

(87) INTERSTATE TRANSPORTATION OF STOLEN PROPERTY

Circle subject
Circle victims in cases involving swindles and thefts
Index suspects
Index writer of outside source mail
Index results of technical surveillances only if information furnished on individuals mentioned
Index original complainant
(It is unnecessary to read or index Investigative Reports beyond the synopsis in this classification)

(88) UNLAWFUL FIGHT TO AVOID PROSECUTION, STUDY, CONFINEMENT,
OR GIVING TESTIMONY

Circle subject
Circle harborers
Index suspects
Index writer of outside source mail
(It is unnecessary to read or index Investigative Reports
beyond the synopsis in this classification)

(89) ASSAULTING OR KILLING A FEDERAL OFFICER; CONGRESSIONAL
ASSASSINATION STATUTE

Circle subject
Circle victim if carried in caption
Index suspects
Index writer of outside source mail
Index original complainant
(It is unnecessary to read or index Investigative Reports
beyond the synopsis in this classification)

(90) IRREGULARITIES IN FEDERAL PENAL INSTITUTIONS

Circle subjects
Circle victim if carried in caption
Circle name of prison or institution
Index suspects
Index writer of outside source mail
Index original complainant
(It is unnecessary to read or index Investigative Reports
beyond the synopsis in this classification)

(91) BANK ROBBERY

Circle subjects
Circle city and underline state and name of bank (Exception:
On Federal Credit Unions, circle on the keyword "Federal
Credit Union")
Underline date of robbery
Index suspects - Scan table of contents if given, as well as
synopsis for guide re indexing suspects beyond the synopsis.
Unnecessary to index suspects who have been eliminated as
suspects, if just a list. However, if descriptions are set
out the suspects should be indexed even though they have
been eliminated.
It is not necessary to index names of bank robbers whose
photographs are taken from the Bank Robbery Album unless
witnesses identify them as suspects.
Index writer of outside source mail
Index original complainant
(It is unnecessary to read or index Investigative Reports
beyond the synopsis in this classification unless suspects
are listed in unknown subject cases)

(92) ANTI-RACKETEERING; ANTI-RACKETEERING, LIAISON ACT; ANTI-RACKETEERING-INTERFERENCE WITH GOVERNMENT COMMUNICATIONS SYSTEM; ANTI-RACKETEERING - HOBBS ACT

Circle subject (individuals, companies, unions)

Circle local numbers of unions and underscore any identifying data such as information as to type of case, date activity took place; location (city and state), and any other information that would help identify the case

Circle victim (company whose commerce is interfered with)

Index suspects

Index writer of outside source mail

Index original complainant

(It is unnecessary to read or index Investigative Reports beyond the synopsis in this classification except in Criminal Intelligence cases where we index associates)

(93) ASCERTAINING FINANCIAL ABILITY

Circle subject

Index writer of outside source mail

(It is unnecessary to read or index Investigative Reports beyond the synopsis in this classification)

(94) RESEARCH MATTERS

Circle subject (individual, organization, magazines, newspapers, Bureau pamphlets, and general file)

Index individuals requesting assistance or material

See Instruction Cards for indexing of newspaper articles, pamphlets, etc.

Index writer of outside source mail

(95) LABORATORY EXAMINATIONS.

Circle subject

Circle victim

If the subject is not given, circle victim and suspect

If the subject and victim are not given, circle suspect

If subject, victim, and suspect are not given, circle the location where the crime occurred

Index writer of outside source mail

Index original complainant

(Above instructions do not apply to check examinations)

(97) REGISTRATION ACT

Circle subject (individual or organization)
Index relatives
Index suspects
Index results of mail covers
Index results of technical surveillances
Index mail drops
Index foreign organizations when pertinent information is given
Index writer of outside source mail
Index employees and members of organizations violating Act
Index temporary (T) informants who are identified as members
or former members of C.P. or any subversive organization
Index original complainant

(98) SABOTAGE

Circle subject
In both known and unknown subject cases, circle companies, firms, corporations, agencies, and defense installations when they are the alleged victims or an integral factor in the investigation and underscore location, date activity took place, and any other pertinent information to facilitate location of various categories of cases involving sabotage to specific companies, firms, railroads, etc. This includes such information as damage to engines, destruction of material, etc.
Circle airplane and underline motor number and serial number when airplane is sabotaged
Circle name of vessel which has been sabotaged
It is unnecessary to circle or index other articles which have been sabotaged
Index suspects
Index relatives of subject
Index writer of outside source mail
Index temporary (T) informants who are identified as members or former members of C.P. or any subversive organization
Index original complainant

((100) SUBVERSIVE MATTER (INDIVIDUALS); INTERNAL SECURITY (ORGANIZATIONS)
(When using general file, circle as °Subversive Matter 100-0)

Circle subject (individual or organization)
Index relatives of subject, including children
Index subversive individuals
Index references
Index subversive organizations when pertinent information is given
Index members of subversive organizations
Index names of subversive films and pamphlets
Index mail drops
Index results of mail covers

(100) SUBVERSIVE MATTER OR INTERNAL SECURITY Continued/

Index results of technical surveillances
Index writer of outside source mail
Index temporary (T) informants who are identified as members
or former members of C.P. or any other subversive organi-
zation
Index original complainant

(102) VOORHIS ACT

Circle subject
Index members of subversive organizations
Index relatives
Index suspects
Index results of mail covers
Index results of technical surveillances
Index original complainant
Index writer of outside source mail

(103) INTERSTATE TRANSPORTATION OF STOLEN CATTLE

Circle subject
Circle victim if carried in caption
Index suspects
Index writer of outside source mail
Index original complainant
(It is unnecessary to read or index Investigative Reports
beyond the synopsis in this classification)

(104) SERVICEMEN'S DEPENDENTS ALLOWANCE ACT OF 1942 (Obsolete)
Use Classification 46

Circle subjects
Index servicemen to whom subject is married if they are not
subjects
Index suspects
Index writer of outside source mail
Index original complainant
(It is unnecessary to read or index Investigative Reports
beyond the synopsis in this classification)

(105) INTERNAL SECURITY - (Nationalistic Tendency - Foreign
Intelligence) (Individuals and Organizations - by Country)
When using the General File 105-0, circle as ^oInternal Security

Circle subject (individual or organization)
Index relatives
See instruction cards: Indexing - Children in Subversive Mail;
Indexing - Children on Forms; Indexing - Relatives of
Children Contacting Embassies; Indexing - Dependents of
Communist-Bloc, Yugoslavian, & Peoples Republic of China
Officials and Employees in the United States; Indexing -
Soviet, Satellite, Yugoslav and Peoples Republic of

Index subversive organizations when pertinent information is
given
Index member of subversive organizations

Index suspects
Index results of mail covers
Index results of technical surveillances
Index mail drops
Index foreign residents on foreign mail
Index temporary (T) informants who are identified as members
or former members of C.P. or any subversive organization
Index writer of outside source mail
Index original complainant

(106) ALIEN ENEMY CONTROL

Circle subject (individual or organization)
Index relatives
Index subversive organizations if pertinent information is
given
Index members of subversive organizations
Index suspects
Index results of mail covers
Index results of technical surveillances
Index original complainant
Index mail drops
Index foreign residents on foreign mail
Index writer of outside source mail
Index individuals suspected of aiding alien enemies

(109) FOREIGN POLITICAL MATTERS

Circle subject (individual or organization or general file)
Index political leaders
Index subversive and political organizations
Index members of subversive and political organizations
Index political prisoners
Index members of revolutionary parties
Index original complainant
Index writer of outside source mail

(110) FOREIGN ECONOMIC MATTERS

Circle subject (firm, organization, individual, or general file)
Index foreign firms, banks, or organizations
Index individuals engaged in economic transactions
Index original complainant
Index writer of outside source mail

(111) FOREIGN SOCIAL CONDITIONS

Circle subject (school, organization, or general file)
Index organizations, movements, and schools if pertinent
information is given
Index original complainant
Index writer of outside source mail

(112) (S) FOREIGN FUNDS

Circle subject (bank, firm, individual, or general file)
Index names of individuals or concerns on which contact cases have been previously opened
Index individuals in the United States who are transmitting funds to Russia or Satellite Countries
Index relatives of subject
Index writer of outside source mail
Index original complainant

(113) (S) FOREIGN MILITARY AND NAVAL MATTERS

Circle subject (individuals, organization, or general file)
Index military and naval officers when pertinent information is given
Index subversive organizations and members
Index relatives of subversive individuals
Index suspects
Index writer of outside source mail
Index original complainant

(114) (S) ALIEN PROPERTY CUSTODIAN MATTER

Circle subject
Index suspects
Index writer of outside source mail
Index original complainant
(It is unnecessary to read or index Investigative Reports beyond the synopsis in this classification)

(115) (C) BOND DEFAULT; BAIL JUMPER

Circle subject (individual who defaults bond)
Index bondsman or surety
Index suspected harborers
Index individuals who withhold information
Index writer of outside source mail
Index original complainant
(It is unnecessary to read or index Investigative Reports beyond the synopsis in this classification)

(116) (S) ENERGY RESEARCH AND DEVELOPMENT ADMINISTRATION-
APPLICANT OR EMPLOYEE (E.R.D.A.)

NUCLEAR REGULATORY COMMISSION-APPLICANT OR EMPLOYEE (N.R.C.)
(See also classification 151)

Circle subject
Index relatives if subversive or derogatory information is given on subject or relatives
Index individuals if subversive or derogatory information is given on the individuals

unless subversive or derogatory information is given)

(117) ATOMIC ENERGY ACT - CRIMINAL VIOLATIONS

Circle subjects

In both known and unknown subject cases, circle companies, firms, corporations, agencies and defense installations when they are the alleged victims or an integral factor in the investigation and underscore location, date activity took place, and any other pertinent information to facilitate location of various categories of cases involving specific companies, Atomic Energy Commission projects, etc. This includes such information as loss of documents, theft of plans, loss of uranium slugs, etc.

If the case involves a document or contract and the number is given, circle "document" or "contract" and underline the number

Index relatives

Index suspects

Index contacts

Index mail drops under names of companies, individuals, and addresses

Index results of mail covers

Index results of technical surveillances

Index individuals in possession of film, drawings, photos, etc.

Index writer of outside source mail

Index original complainant

(119) FEDERAL REGULATION OF LOBBYING ACT

Circle subject

Index individuals in contact with lobbyist

Index writer of outside source mail

Index original complainant

(It is unnecessary to read Investigative Reports beyond the synopsis in this classification)

(120) FEDERAL TORT CLAIMS ACT

Circle subjects (individuals suing Government)

Circle victims (individuals injured or killed if carried in caption)

Index individuals responsible (Government employees who caused the accident)

Index writer of outside source mail

Index original complainant

(It is unnecessary to read Investigative Reports beyond the synopsis in this classification)

(122) LABOR MANAGEMENT RELATIONS ACT, 1947

Circle subject (the violators)

Circle the name of the plant if the violation involves a strike and underline the location

Circle the name of the union if the union is a violator

Index suspects

It is not necessary to index union members unless they are suspects, agitators or subversive

Index writer of outside source mail

Index original complainant

(It is unnecessary to read or index Investigative Reports beyond the synopsis in this classification)

- (123) SPECIAL INQUIRY - STATE DEPARTMENT - VOICE OF AMERICA
(U.S. INFORMATION CENTER) (CLOSED-SEE 151 CLASSIFICATION)

Circle subject

Index relatives if subversive or derogatory information is given on the subject or relatives

Index individuals if subversive or derogatory information is given

(Do not read beyond the synopsis unless subversive or derogatory information is given)

- (124) EUROPEAN RECOVERY PROGRAM; AID-AGENCY FOR INTERNATIONAL DEVELOPMENT (CLOSED-SEE 151 CLASSIFICATION)

Circle subject

Index relatives if subversive or derogatory information is given on subject or relatives

Index individuals if subversive or derogatory information is given

(Do not read beyond the synopsis unless subversive or derogatory information is given)

- (125) RAILWAY LABOR ACT

Circle subject

Index suspects

Index subversive individuals

Index writer of outside source mail

Index original complainant

(It is unnecessary to read or index Investigative Reports beyond the synopsis in this classification)

- (128) INTERNATIONAL DEVELOPMENT PROGRAM (CLOSED-SEE 151 CLASSIFICATION)

Circle subject

Index relatives if subversive or derogatory information is given on the subject or relatives

Index individuals if subversive or derogatory information is given

(Do not read beyond the synopsis unless subversive or derogatory information is given)

- (129) EVACUATION CLAIMS (OBSOLETE)

Circle subject and trustee or representative

underline claim number

Continued on next page

(129) EVACUATION CLAIMS (Obsolete) /Continued/

Index writer of outside source mail
Index original complainant
(It is unnecessary to read or index Investigative Reports
beyond the synopsis in this classification)

(131) ADMIRALTY MATTER

Circle name of Litigants (companies or individuals)
Circle the name of vessels involved
Underline admiralty number
Index writer of outside source mail
Index original complainant
(It is unnecessary to read or index Investigative Reports
beyond the synopsis in this classification)

(133) NATIONAL SCIENCE FOUNDATION ACT (CLOSED - SEE 151-CLASSIFICATION)

Circle subject
Index relatives if subversive or derogatory information is
given on subject or relatives
Index individuals if subversive or derogatory information is
given
(Do not read beyond the synopsis unless subversive or
derogatory information is given)

(134) SECURITY INFORMANTS

Circle subject (When more than one informant is carried in title,
circle both into same file and G.I. will return to have copy
placed if they have separate files.)
Circle "°Conf. Inft.", "°Conf. Source" or "°Panel Source" and
underscore symbol number. (See Inst. Card:CONFIDENTIAL
INFORMANTS)
Index relatives of informant if they are subversive or if the
informant belongs to or has belonged to a subversive
organization
Justification letters should not be indexed
Resumes of information furnished by informants in order for
the Bureau to evaluate his services should not be indexed
Index original complainant
Index writers of outside source mail

(135) PROSAB
(PROTECTION OF STRATEGIC AIR COMMAND BASES OF U.S.A. AIR FORCE)

The Bureau does not open main files at F.B.I.H.Q. unless the
Supervisor specifically requests it
See General file on Standard Sub List - °PROSAB - 98-38030-
with subs for the field offices
Do not index informant's unless derogatory or subversive infor-
mation is furnished regarding them
Do not index the names of plants or facilities where the infor-
mants are employed

Index original complainant

(136) AMERICAN LEGION CONTACTS (Obsolete)

The Bureau does not open main files on American Legion Contacts at the Seat of Government unless the Supervisor makes a special request

If necessary to open a file, circle subject, otherwise, use American Legion Contacts on Standard Sub List

Do not index contacts unless derogatory or subversive information is furnished regarding them

Do not index American Legion Posts

Index writer of outside source mail

Index original complainant

(137) CRIMINAL INFORMANTS

Circle subject

Circle "Conf. Inft." or "Conf. Source" and underscore symbol number

Justification letters should not be indexed

Unnecessary to index relatives unless unusual circumstances are involved

Resumes of information furnished by informants in order for the Bureau to evaluate services should not be indexed

Index writer of outside source mail

Index original complainant

(138) LOYALTY OF EMPLOYEES OF THE UNITED NATIONS AND OTHER PUBLIC INTERNATIONAL ORGANIZATIONS

Circle subject

Index relatives if subversive or derogatory information is given on subject or relatives

Index individuals if subversive or derogatory information is given

Index references if there is a doubt as to subject's loyalty

Index subversive organizations when pertinent information is given

Index mail drops

Index results of mail covers

Index results of technical surveillances

Index writer of outside source mail

Index original complainant

(139) INTERCEPTION OF COMMUNICATIONS (Formerly UNAUTHORIZED PUBLICATION OR USE OF COMMUNICATIONS)

Circle subjects

Index suspects

Index writer of outside source mail

Index original complainant

(It is unnecessary to read or index Investigative Reports beyond the synopsis in this classification)

4/10/70

(140) (S) SECURITY OF GOVERNMENT EMPLOYEES (G.E.)

Circle subject
Index relatives if subversive or derogatory information is given on subject or relatives
Index references if there is a doubt as to subject's loyalty
Index individuals if subversive or derogatory information is given
Index subversive organizations when pertinent information is given
Index mail drops
Index results of mail covers
Index results of technical surveillances
Index writer of outside source mail
Index original complainant

(141) (C) FALSE ENTRIES IN RECORDS OF INTERSTATE CARRIERS (F.E.R.I.C.)

Circle subjects
Index suspects
Index writer of outside source mail
Index original complainant
(Do not index results of technical surveillances
(It is unnecessary to read or index Investigative Reports beyond the synopsis in this classification)

(142) (C) ILLEGAL USE OF RAILROAD PASS

Circle subjects
Index suspects
Index writer of outside source mail
Index original complainant
(Do not index results of technical surveillances
(It is unnecessary to read or index Investigative Reports beyond the synopsis in this classification)

(143) (C) INTERSTATE TRANSPORTATION OF GAMBLING DEVICES (I.T.G.D.)

Circle subjects (individuals, companies, manufacturer, or dealer)
Index suspects
Index writer of outside source mail
Index original complainant
Index serial numbers of gambling devices only if so indicated by the Supervisor
(It is unnecessary to read or index Investigative Reports beyond the synopsis in this classification)

(144) (C) INTERSTATE TRANSPORTATION OF LOTTERY TICKETS (I.T.L.T.)

Circle subjects (individuals, companies, organizations)
Index suspects
Index names of lotteries

/continued/

(144) (C) INTERSTATE TRANSPORTATION OF LOTTERY TICKETS /continued/

Index buyers of material
Index writer of outside source mail
Index original complainant
(Do not index results of technical surveillances
(It is unnecessary to read or index Investigative Reports beyond the synopsis in this classification)

(145) (C) INTERSTATE TRANSPORTATION OF OBSCENE MATTER; BROADCASTING OBSCENE LANGUAGE (I.T.O.M.) (B.O.L.)

Circle subjects (individuals, companies, organizations)
Index suspects
Index titles of obscene films and literature
Index buyers of material
Index writer of outside source mail
Index original complainant
(Do not index results of technical surveillances
(It is unnecessary to read or index Investigative Reports beyond the synopsis in this classification)

(146) (C) INTERSTATE TRANSPORTATION OF PRISON MADE GOODS (I.T.P.M.G.)

Circle subjects (individuals, companies, prisons, organizations)
Index suspects
Index buyers of material
Index writer of outside source mail
Index original complainant
(Do not index results of technical surveillances
(It is unnecessary to read or index Investigative Reports beyond the synopsis in this classification)

(147) (C) FEDERAL HOUSING ADMINISTRATION MATTERS (F.H.A.M.)

Circle subjects (individuals, companies or organizations)
Index suspects
Index Government employees who appear to be implicated if they are not subjects
Index writer of outside source mail
Index original complainant
(It is unnecessary to read or index Investigative Reports beyond the synopsis in this classification)

(148) (C) INTERSTATE TRANSPORTATION OF FIREWORKS (I.T.F.)

Circle subjects (individuals and companies)
Index suspects
Index buyer of material
Index writer of outside source mail
Index original complainant
(Do not index results of technical surveillances
(It is unnecessary to read or index Investigative Reports beyond the synopsis in this classification)

(149) DESTRUCTION OF AIRCRAFT OR MOTOR VEHICLES

Circle subjects (Do not circle the airlines)

In unknown subject cases, circle airline or bus company.

If both unknown, circle airport, terminal, depot, hangar, or garage, underscore location and date of activity. If all of above are unknown, circle airplane, or motor vehicle and underline motor numbers.

Index suspects

Index writer of outside source mail

Index original complainant

(It is unnecessary to read or index Investigative Reports beyond the synopsis in this classification)

(151) NATIONAL AERONAUTICS AND SPACE ACT OF 1958 - APPLICANT
UNITED STATES ARMS CONTROL AND DISARMAMENT AGENCY -
APPLICANT (ALL APPLICANT CASES REFERRED FROM CSC UNDER P.L. 298)

Circle subject

Index relatives if subversive or derogatory information is given on subject or relatives

Index individuals if subversive or derogatory information is given on the individuals

(It is unnecessary to read or index Investigative Reports beyond the synopsis in this classification unless subversive or derogatory information is given)

(^oApplicants - Referral Cases 151-0)

(152) SWITCHBLADE KNIFE ACT

Circle subjects (individuals, organizations)

Index suspects

Index writer of outside source mail

Index original complainant

(It is unnecessary to read or index Investigative Reports beyond the synopsis in this classification)

(153) AUTOMOBILE INFORMATION DISCLOSURE ACT

Circle subject (name of company or individual against whom complaint is made)

Circle owner of company if carried in caption

If subject is unknown circle company or individual offering unlabeled vehicle for sale

If subject is unknown and more than one company is given, circle name of last company to have possession of unlabeled vehicle

If subject is unknown and there is no company or individual mentioned in the synopsis, circle the automobile

Unnecessary to index the automobile

Index writer of outside source mail

Index original complainant

(It is unnecessary to read or index Investigative Reports beyond the synopsis in this classification)

4/10/70

(154) INTERSTATE TRANSPORTATION OF UNSAFE REFRIGERATORS

Circle subjects

Index suspects

Index writer of outside source mail

Index original complainant

(It is unnecessary to read Investigative Reports beyond the synopsis in this classification)

(155) NATIONAL AERONAUTICS AND SPACE ACT OF 1958 - CRIMINAL VIOLATIONS

Circle subjects

In both known and unknown subject cases, circle companies, firms, corporations, agencies and defense installations when they are the alleged victim or an integral factor in the investigation and underscore location, date activity took place, and any other pertinent information to facilitate location of various categories of cases involving specific companies, National Aeronautics and Space Agency projects, etc.

If the case involves a document or contract and the number is given, circle "document" or "contract" and underline the number

Index relatives

Index suspects

Index contacts

Index mail drops under names of companies, individuals, and addresses

Index results of mail covers

Index results of technical surveillances

Index individuals in possession of film, drawings, photos, etc

Index writer of outside source mail

Index original complainant

(156) EMPLOYEE RETIREMENT INCOME SECURITY ACT

Circle subject (name of subject and name of company)

Index trustees

Index suspects

Index writer of outside source mail

Index original complainant

(It is unnecessary to read or index Investigative Reports beyond the synopsis in this classification)

Do not circle or index name of welfare plan or group.

(157) EXTREMIST MATTERS; CIVIL UNREST

Circle subject

Circle victims

Index suspects

Index writer of outside source mail

Index original complainant

(Index relatives when on an individual and not a particular incident)

(158) LABOR - MANAGEMENT REPORTING AND DISCLOSURE ACT OF 1959 -
SECURITY MATTER (Obsolete)

Circle subject (individual, union or local)
Index relatives of subject including children if information is recent
Index subversive individuals if information is recent
Index references
Index subversive organizations when pertinent information is given
Index members of subversive organization if information is recent
Index mail drops
Index results of mail covers
Index results of technical surveillances
Index writer of outside source mail
Index temporary (T) informants who are identified as members or former members of C.P. or any other subversive organization
Index original complainant

(159) LABOR - MANAGEMENT REPORTING AND DISCLOSURE ACT OF 1959 -
INVESTIGATIVE MATTER

Circle subject
Circle name of plant and underline location if the violation involves a strike
Circle name of union if union is violator
Circle name of local if local is violator
Index suspects
It is not necessary to index union members unless they are suspects, agitators or subversive
Index writer of outside source mail
Index original complainant
(It is not necessary to read Investigative Reports beyond the synopsis in this classification)

(160) FEDERAL TRAIN WRECK STATUTE

Circle subject
In both known and unknown subject cases, circle railroad company when it is the alleged victim or an integral factor in the investigation and underscore location, date activity took place, and any other pertinent information
Index suspects
Index relatives of subjects (Unnecessary to index relatives of juveniles)
Index writer of outside source mail
Index original complainant
(It is not necessary to read Investigative Reports beyond the synopsis in this classification)

() SPECIAL INQUIRIES FOR WHITE HOUSE, CONGRESSIONAL COMMITTEES,
AND OTHER GOVERNMENT AGENCIES: (SEE CLASSIFICATION 151 for
PEACE CORPS; ACTION)

Circle subject

See instructions under "Applicant Mail"

Index relatives if subversive or derogatory information is
given on subject or relatives

Index individuals if subversive or derogatory information is
given on the individuals

(It is unnecessary to read or index Investigative Reports
beyond the synopsis in this classification unless sub-
versive or derogatory information is given)

(162) INTERSTATE GAMBLING ACTIVITIES

Circle subject (individuals, companies or organizations)

Index suspects

Index subscribers (Supervisor will underline in green)

Index receivers of information

Index wire services

Index writer of outside source mail

Index original complainant

Unnecessary to index associates unless underlined in green
by the Supervisor

(It is unnecessary to read or index Investigative Reports
beyond the synopsis in this classification)

((163) FOREIGN POLICE COOPERATION

Circle subject

Index subversive individuals

No other indexing necessary unless underlined in green by
Supervisor

(It is unnecessary to read Investigative Reports beyond
the synopsis in this classification)

(164) CRIME ABOARD AIRCRAFT

Circle subject

Circle victim if carried in caption

Circle name of airlines if names of subject and victim are unknown

Index suspects

Index writer of outside source mail

Index original complainant

(It is unnecessary to read or index Investigative Reports
beyond the synopsis in this classification)

(165) INTERSTATE TRANSMISSION OF WAGERING INFORMATION

Circle subject (individuals, companies or organizations)

Index suspects

Index subscribers (Supervisor will underline in green)

Index wire services

Index receivers of information

Index writer of outside source mail

Index original complainant

(It is unnecessary to read or index Investigative Reports
beyond the synopsis in this classification)

(166) (C) INTERSTATE TRANSPORTATION IN AID OF RAFFLE TICKETING (I.T.A.R.)

Circle subject
Index suspects
Index receivers of information
Unnecessary to index associates unless underlined in green
by Supervisor
(It is unnecessary to read or index Investigative
Reports beyond the synopsis in this classification)

(167) (C) DESTRUCTION OF INTERSTATE PROPERTY (D.I.P)

Circle subject
If the subject is unknown, circle the carrier
If the subject is unknown and the carrier is not given, circle
The Consignee and the Consignor
If the subject is unknown underscore all identifying data, such
as information as to type of case, date activity took place
location (city and state) and any other information that
would aid in identifying the case.
Circle the victim if carried in caption in cases involving
destruction of passengers' property traveling interstate
Index suspects
Index writer of outside source mail
Index original complainant
(Do not index results of technical surveillances
(It is unnecessary to read or index Investigative Reports
beyond the synopsis in this classification)

(168) (C) INTERSTATE TRANSPORTATION OF WAGERING PARAPHERNALIA (I.T.W.P.)

Circle subject (individuals, companies or organizations)
Index suspects
Index organizations handling paraphernalia
Index wire services
Index receivers of paraphernalia
Unnecessary to index associates unless underlined in green
by Supervisor
Index writer of outside source mail
Index original complainant
(It is unnecessary to read or index Investigative Reports
beyond the synopsis in this classification)

(169) HYDRAULIC BRAKE FLUID ACT (Obsol.)

Circle subject (individuals or Companies)
Index suspects
Index writer of outside source mail
Index original complainant
(It is unnecessary to read Investigative Reports
beyond the synopsis in this classification)

(170) EXTREMIST INFORMANTS

Circle subject
Circle "Conf. Inft." or "Conf. Source" and underscore
symbol number
Index relatives of informant if they are subversive or
if the informant belongs to or has belonged to a
subversive organization
Justification letters should not be indexed
Resumes of information furnished by informants in order
for the Bureau to evaluate his services should not
be indexed
Index original complainant
Index writers of outside source mail

(171) MOTOR VEHICLE SEAT BELT ACT (Obsolete)

Circle subject
Index suspects
Index writer of outside source mail
Index original complainant
(It is unnecessary to read or index Investigative
Reports beyond the synopsis in this classification)

(172) SPORTS BRIBERY

Circle subject (persons offering and accepting bribes)
Index suspects
Index individual accepting bribe if he cooperates with
the Bureau and has informed the Bureau of the bribe
Index writer of outside source mail
Index original complainant
(It is unnecessary to read or index Investigative
Reports beyond the synopsis in this classification)

- (173) PUBLIC ACCOMMODATIONS - CIVIL RIGHTS ACT-1964;
PUBLIC EDUCATION - CIVIL RIGHTS ACT-1964;
PUBLIC FACILITIES - CIVIL RIGHTS ACT-1964;
EMPLOYMENT - CIVIL RIGHTS ACT-1964

Circle subject
Circle name of accommodation, facility or educational
institution
Underline city, state, and date
Circle victims
Index suspects
Index writer of outside source mail
Index original complainant
(It is unnecessary to read or index Investigative
Reports beyond the synopsis in this classification.)

- (174) EXPLOSIVES AND INCENDIARY DEVICES;
BOMB THREATS
(Formerly Bombing Matters; Bombing Matters-Threats)

Circle subject
Circle victim
Index suspects
Index writer of outside source mail
Index original complainant
Index relatives if subversive information is given
on subject or relatives
(See Instruction Card re: general files)

- (175) ASSAULTING THE PRESIDENT (or VICE-PRESIDENT) OF
THE UNITED STATES

Circle subject
Circle victim
Index suspects
Index relatives of subject
Index subversive individuals.
Index writer of outside source mail
Index original complainant

- (176) ANTIRIOT LAWS

Circle subject
Index suspects
Index writer of outside source mail
Index original complainant
Index subversive individuals
Index relatives only if subversive or involved

(177) DISCRIMINATION IN HOUSING

Circle subject
Circle victims
Index suspects
Index writer of outside source mail
Index original complainant
(It is unnecessary to read or index Investigative
Reports beyond the synopsis in this classification)

(178) INTERSTATE OBSCENE OR HARASSING TELEPHONE CALLS

Circle subject
Circle victim
Index suspects
Index writer of outside source mail
Index original complainant
(It is unnecessary to read or index Investigative
Reports beyond the synopsis of this classification)

(179) EXTORTIONATE CREDIT TRANSACTIONS

Circle subject
Circle victim
Index suspects
Index writer of outside source mail
Index original complainant
(It is unnecessary to read or index Investigative
Reports beyond the synopsis of this classification)

(180) DESECRATION OF THE FLAG

Circle subject
Index subversive individuals
Index relatives of subject
Index writer of outside source mail
Index original complainant

(181) CONSUMER CREDIT PROTECTION ACT

Circle subject
Circle victim
Index suspects
Index writer of outside source mail
Index original complainant
(It is unnecessary to read or index Investigative
Reports beyond the synopsis in this classification)

(182) ILLEGAL GAMBLING BUSINESS;
ILLEGAL GAMBLING BUSINESS - OBSTRUCTION;
ILLEGAL GAMBLING BUSINESS - FORFEITURE

Circle subject (individuals or companies)
Index suspects
Index writer of outside source mail
Index original complainant
(It is unnecessary to read Investigative
Reports beyond the synopsis in this classification)

(183) RACKETEER INFLUENCED AND CORRUPT ORGANIZATIONS

Circle subject
Index suspects
Index writer of outside source mail
Index original complainant
(It is unnecessary to read Investigative
Reports beyond the synopsis in this classification)

(184) POLICE KILLINGS

Circle subject
Index subversive individuals
Index relatives of subject
Index writer of outside source mail
Index original complainant

(185) PROTECTION OF FOREIGN OFFICIALS AND OFFICIAL GUESTS OF
THE UNITED STATES

Circle subject
Circle victim
Index suspects
Index relatives of subject
Index subversive individuals
Index writer of outside source mail
Index original complainant

RULES PERTAINING TO THE GENERAL INDEX

OLD CARDS

(Old German, Miscellaneous, Bureau Section and Mexican) are cards referring to old files. These files mainly concern World War I, and cards pertaining to them are being removed from the General Index and microfilmed.

PARENTHESIS

Words in parenthesis should be disregarded in filing. Formerly Spanish names were written with part of the name in parenthesis.

Disregard in filing cards.

Example:

LOPEZ, JUAN (Y RODRIGUEZ) will be filed in the same place in the index as LOPEZ, JUAN.

Exception:

Mrs. in parenthesis, if already in the index should be regarded if used with a masculine name as:
JONES, HERMAN. (MRS.)

ABBREVIATIONS

When an abbreviation is known or readily available, the Classifier should write out the full name of the particular abbreviation and the typist should prepare the cards fully written out. Abbreviations automatically recognized by anyone handling cards should be given to their supervisor. The exceptions to the above rule are in titles of books, newspapers, editorials, etc. in which abbreviations appear. These abbreviations should not be written out but should be filed and cards made exactly as the title is set forth in the mail. Federal Bureau of Investigation and United States of America should always be written or typed in the abbreviated form, as F.B.I. and U.S.A. Czechoslovakia and variations such as Czechoslovakian will be abbreviated Czech (per Streamlining Committee 9-14-66). National Crime Information Center will be abbreviated N.C.I.C. (per Agent's conference 2-2-71).

ADDRESS CARDS

There are two breakdowns for address cards, one for Domestic and one for Foreign. Domestic address cards are filed numerically within the state breakdown, irrespective of city. Foreign address cards are filed numerically within the country breakdowns, irrespective of the city. Main address cards are filed in strict numerical order within the State or Country breakdown. The cards are made as follows:

A. DOMESTIC

818 Nichols St., Greenwich, Conn.

ADDRESS	CONNECTICUT	GREENWICH
818 Nichols St.		

Post Office Box #2345, Chicago, Ill., Franklin Station

ADDRESS	ILLINOIS	Chicago
P.O. Box 2345		
Franklin Station		

B. CARDS BEARING NEW YORK ADDRESSES

It is characteristic of some New York City addresses to contain dashes (-) as shown in the following example. Such addresses will be treated as follows: (on page 2)

(a) Address - 158-22, 142nd St., NYC

ADDRESS	NEW YORK	NEW YORK
158-22, 142nd St.		

When a dash (-) appears on the mail, the typist is to type the dash on the card as shown above. This card indicates that "158" is the block number and the "22" is the house number, in the 158th block of 142nd Street. It will be filed numerically as "15822" in the New York breakdown regardless of the city.

This is not to be confused with house numbers that cover more than one street address as this is a common practice not only in New York but throughout the United States. In these cases two cards are to be made.

Examples:

(b) Address - 96-100 Broadway, NYC

(1) ADDRESS	NEW YORK	NEW YORK
96 Broadway		

96-100 Broadway (dropped down two spaces)

Such cards are filed numerically regarding the "96" only behind the New York state tab regardless of the city.

(2) ADDRESS	NEW YORK	NEW YORK
100 Broadway		

96-100 Broadway (dropped down two spaces)

Such cards are filed numerically regarding the "100" only behind the New York state tab regardless of the city.

C. FOREIGN

Foreign address cards are to be typed and filed in the same manner as the domestic address cards, that is, main and see cards are filed numerically within a country breakdown regardless of the city. House numbers, P.O. numbers, street numbers, etc. are to be regarded in filing as the case may be.

Example:

(a) Address - Rua De Alrandaga NO.44 - Rio De Janeiro, Brazil

ADDRESS	BRAZIL	RIO DE JANEIRO
Rua De Alfandaga No. 44		

AIRLINES: (indexing in known subject cases in the 149 classification)

The airline will not be indexed when the subject is known.

Example:

JOHN^OADAMS; THREAT TO BOMB AMERICAN AIRLINES

Card typed:

ADAMS, JOHN

APOSTROPHE "S"

When filing words or names containing 'S or S' the "S" is regarded.

Example:

Bill'S CAFE Filed: "BILLS" behind the "C" tab.
PEOPLE'S WORLD Filed: "PEOPLES" behind the "W" tab.

If the name should appear on the mail as "Bill Jackson's Book Shop" and the Classifier wants to index the name of the individual and not the book shop, it will be up to the Classifier to write the name of the individual on the side of the mail.

BANKS

A. All banks located in the United States, foreign or American, should be indexed on the City and State and not on the name of the bank.

Example: Banco de la Costa Rica, New York, New York

Card made: NEW YORK, NEW YORK

BANCO DE LA COSTA RICA

First National Bank, Philadelphia, Pa.

Card made: PHILADELPHIA, PENNSYLVANIA

FIRST NATIONAL BANK

B. All banks located in foreign countries, foreign or American, should be indexed on the name of the bank with the address dropped.

Example: ^XChase National Bank, London, England

Card made: CHASE NATIONAL BANK

^xBanco de Italiene, Rome, Italy

Card made: BANCO DE ITALIENE

C. Banks located in Territorial Possessions of the United States will be treated as foreign.

Example: ^xFirst National Bank, San Juan, Puerto Rico

Card made: ONE NATIONAL BANK

^xBank of America, Charlotte Amalie, Virgin Islands

Card made: BANK OF AMERICA

CAFES, RESTAURANTS, CLUBS AND HOTELS

Names of cafes, restaurants, clubs and hotels are to be classified on the proper name and not on the word "cafe," "restaurant," "club" or "hotel."

Example:

Club ^x Zanzibar	Typed: <u>ZANZIBAR CLUB</u>	Filed: ZANZIBAR behind C tab.
Cafe ^x S & W	Typed: S AND W CAFE	Filed: S Behind "A" tab.
Restaurant ^x Bavaria	Typed: BAVARIA RESTAURANT	Filed: BAVARIA behind "R" tab.
Hotel ^x New Yorker	Typed: <u>NEW YORKER HOTEL</u>	Filed: NEW behind "Y" tab.

X- CITY CARDS FOLLOWED BY ORGANIZATIONS, ETC.

All cards on organizations, newspapers, public utilities, etc. preceded by the name of a city will be made with the name of the city only, without the state following.

Example:

Charlotte, North Carolina Water Works Typed: CHARLOTTE WATER
WORKS

Example: San Francisco, California Examiner

Typed: SAN FRANCISCO EXAMINER

CONFIDENTIAL INFORMANTS:

Confidential Informants are filed numerically and the symbol is dropped to the body of the card.

Example: CONFIDENTIAL INFORMANT NY 680-C

Card: CONFIDENTIAL INFORMANT #680

NY-C (dropped to title line)

CONFIDENTIAL SOURCE:

Cards are made up Confidential Source #10, filed Confidential behind "S" tab by number.

PANEL SOURCE:

Cards are made up Panel Source #889, filed Panel first, Source is filed second and the numbers filed third with symbols dropped to the body of the card.

CULT NAMES

"Bey" and "El" are Moorish religious titles added to a surname. Such titles are treated as follows:

Example: Mary ^x Jones Bey

Typed: JONES, MARY Filed: JONES behind "M" tab.

(drop down) MARY JONES BEY

"Sister" is often used with these names. The name Sister Jones Bey would be treated as follows:

Example: Sister ^x Jones Bey

Typed: JONES, ONE Filed: JONES before "A" tab

(drop down) SISTER JONES BEY

Sister John Smith El would be treated as follows:

Example: Sister John ^x Smith El

Typed: SMITH, JOHN MRS. Filed: SMITH behind "J" tab

(drop down) MRS. JOHN SMITH EL

No card should be made when the name appears with only the titles as MR. Bev or Sister El.

DEPARTMENT OF, BUREAU OF, OFFICE OF, BOARD OF, ETC.

All federal, state and miscellaneous departments and bureaus are indexed and typed on the name of the department, bureau, or office.

EXAMPLES:

Board of Immigration and Naturalization

Department of Agriculture

Bureau of Standards

Bureau of Accounts

Department of Science

Office of Censorship

CARDS TYPED:

IMMIGRATION AND

NATURALIZATION BOARD

AGRICULTURE DEPARTMENT

STANDARDS BUREAU

ACCOUNTS BUREAU

SCIENCE DEPARTMENT

CENSORSHIP OFFICE

DESEGREGATION OF PUBLIC SCHOOLS:

1. Mail for the STATE MASTER FILE will be circled under the key phrase "DESEGREGATION OF PUBLIC SCHOOLS" and responsibility of classifier to underline the name of the state if not set out in the caption. Memos, airtels, teletypes, letters from field offices setting forth school activities in more than one city, county, parish, school district, separate school districts, municipal school, must be classified into the file for the state. Not necessary to place copies in the various county, city, parish, etc. file.

2. Mail for the city, county, parish, school district, separate school district, municipal school MASTER FILE will be circled under the key phrase "DESEGREGATION OF PUBLIC SCHOOLS." In addition, mail will be circled under the city, county, parish, school district, separate school district, municipal school.

3. 173-0- OUTSIDE SOURCE MAIL ONLY.

4. 173-4 is for memos and outgoing instructions to more than one field office in regard to public education.

5. 173-4- subs for field offices-mail from field offices (zero type mail) in regard to public education not requiring an investigation.

2/15/59

DESEGREGATION OF PUBLIC SCHOOLS:

6. Interference and non-compliance cases will have a new file opened for each separate case. Subjects and victims will be circled. Index complainants only if name is in body of first communication. If complainant is carried in title, complainant is to be circled.

EXAMPLES:

STATE

Mail is incoming airtel from Norfolk, Virginia in regard to survey of school situation in various city, counties, etc. is captioned as:

DESEGREGATION OF PUBLIC SCHOOLS
CRA, 1964

CLASSIFY AS:

0
Desegregation of Public Schools State of Virginia
CRA, 1964

CITY

DESEGREGATION OF PUBLIC SCHOOLS
TUSCALOOSA CITY SCHOOLS
TUSCALOOSA, ALABAMA

CLASSIFY AS:

0
DESEGREGATION OF PUBLIC SCHOOLS
TUSCALOOSA CITY SCHOOLS
TUSCALOOSA, ALABAMA

COUNTY

DESEGREGATION OF PUBLIC SCHOOLS
NORTHAMPTON COUNTY BOARD OF EDUCATION
NORTHAMPTON COUNTY, N.C.
CRA, 1964

CLASSIFY AS:

0
DESEGREGATION OF PUBLIC SCHOOLS
NORTHAMPTON COUNTY BOARD OF EDUCATION
NORTHAMPTON COUNTY NORTH CAROLINA

DESEGREGATION OF PUBLIC SCHOOLS

PARISH

DESEGREGATION OF PUBLIC SCHOOLS, WASHINGTON PARISH PUBLIC SCHOOLS

WASHINGTON PARISH, LOUISIANA

CLASSIFY AS:

DESEGREGATION OF PUBLIC SCHOOLS

WASHINGTON PARISH PUBLIC SCHOOLS

WASHINGTON PARISH, LOUISIANA

SCHOOL DISTRICT

DESEGREGATION OF PUBLIC SCHOOLS, BRADLEY COUNTY SCHOOL DISTRICT NO. 14

BRADLEY COUNTY, ARKANSAS

CLASSIFY AS:

DESEGREGATION OF PUBLIC SCHOOLS

BRADLEY COUNTY SCHOOL DISTRICT NO. 14

BRADLEY COUNTY, ARKANSAS

SEPARATE SCHOOL DISTRICT

DESEGREGATION OF PUBLIC SCHOOLS

BILOXI MUNICIPAL SEPARATE SCHOOL DISTRICT

BILOXI, MISS.

CLASSIFY AS:

DESEGREGATION OF PUBLIC SCHOOLS

BILOXI MUNICIPAL SEPARATE SCHOOL DISTRICT

BILOXI, MISSISSIPPI

173-0-

NO EXAMPLE NEEDED

173-4

NO EXAMPLE NEEDED

173-4-SUBS FOR FIELD

UNSUB: DEMONSTRATION AT SHADY GROVE SCHOOL, ROSEDALE, LOUISIANA

3/23/71

FE: CRA 1964

DESEGREGATION OF PUBLIC SCHOOLS

CLASSIFY AS :

UNSUB: DEMONSTRATION AT^x SHADY GROVE SCHOOL,
ROSEDALE, LOUISIANA
3/23/71

FE: CRA, 1964 ° PUBLIC EDUCATION-N.O.

NON COMPLIANCE
NON-COMPLIANCE SCHOOL DESEGREGATION
STARKVILLE, MISSISSIPPI PUBLIC SCHOOL
MRS. BERNICE ARMSTEAD; MRS. GLEN REEVES;
MRS. MAXINE HENRY-COMPLAINANTS
PE-CRA of 1964

CLASSIFY AS:

NON-COMPLIANCE SCHOOL DESEGREGATION
° STARKVILLE, MISSISSIPPI PUBLIC SCHOOL
MRS. BERNICE ° ARMSTEAD; MRS. GLEN ° REEVES;
MRS. MAXINE ° HENRY-COMPLAINANTS
PE-CRS of 1964

DOUBLE SURNAMES

Double English surnames not joined by a hyphen should be filed according to the last part of the name as it is difficult to distinguish whether the first part of the double name is a middle name or part of the surname.

EXAMPLES:

CARDS TYPED:

FILED

JOHN SMITH JONES

JONES, JOHN SMITH

JONES BEHIND "J" TAB.

WILLIAM SPENCE OLDS

OLDS, WILLIAM SPENCE

OLDS BEHIND "W" TAB.

If it can be determined in a woman's name that the middle name is her maiden name, the classifier should classify on this name also. See instructions on "Maiden Names."

FAMILY CARDS

All cards made on a particular family, such as the Brown Family, should be typed "BROWN, ONE". The typist should drop down two spaces and type "Family".

FIREARMS EXAMINATIONS (KEYWORD):

This keyword will be restricted to requests for examinations of firearms by the Bureau Laboratory. It will concern the 95 classification and be filed by locality.

EXAMPLE:

Request for ballistics test of Gun #3,468. Memphis, Tennessee
Police Department

CARD TYPED:

FIREARMS EXAMINATIONS

MEMPHIS, TENN.

FOREIGN ARTICLES

All foreign articles are filed as written, when not appearing in an individual's name. Example:

La Cruz Del Sud (publication) LA CRUZ DEL SUD Filed: LA behind "C" tab.

✓ FOREIGN FIRMS

No effort should be made to interpret the meaning of any foreign words in a firm name. They should be written in the same order as they appear on the mail with the exception of "CIA", "CIE", "LTD", & "LTDA".

Cia - Compania
Cie - Companie
Ltd - Limited
Ltda - Limitada

This includes foreign articles and prepositions preceding foreign firms. Examples:

Jose Rodriguez Compania RODRIQUEZ, JOSE COMPANIA
Juan Lopez Cia LOPEZ, JUAN COMPANIA
Banco Germanci De La America Del Sud BANCO GERMANCI DE LA AMERICA DEL
SUD
Lopez Y Rodriquez LOPEZ Y RODRIQUEZ (Filed "Lopez"
behind "Y" tab)

FOREIGN NAMES

A. SPANISH NAMES

Spanish names are classified before each surname and a card is typed on each surname using the given name. On the last surname, the card is made with the complete name on the top line rather than with just the given name. No card is necessary on the prefix De, La, etc., combined with the name following it.

On all cards where the complete name does not appear on the top line, the complete name must be dropped to the body of the card. Examples:

Jose ^xRodriguez De ^xLopez Y ^xAlonzo

- Cards typed: 1. RODRIGUEZ, JOSE
2. LOPEZ, JOSE
3. ALONZO, JOSE RODRIGUEZ DE LOPEZ

In each instance on the above cards the full name will be dropped two spaces below the top line, including the last card where only the "Y" is left off the top line.

The letter "Y" and the word "VDA" or "VIUDA" (meaning widow of) should be left off the top line of the card.

* If when making a card, a prefix appears at the end of the entry, it should be omitted on the top line. The complete name is dropped down on the cards.

Example: PEDRO LOPEZ DE GOMEZ

- Cards typed: 1. LOPEZ, PEDRO
2. GOMEZ, PEDRO LOPEZ
(Complete name dropped on both cards)

San in Spanish names should only be circled on the first part of the name

Maria San Jose

○ SAN JOSE, MARIA

When no given name is used with a Spanish surname, it is classified and the cards typed on each name; no card is made on the complete name.

Example: Dr. Rodriguez De Lopez

- Cards typed: 1. RODRIGUEZ, ONE
2. LOPEZ, ONE
(Complete name dropped on both cards)

∨ If an initial or prefixed initial is given as part of a Spanish surname, it is omitted on the top line when typing the card.

Example: Jose Rodriguez L.

Typed: RODRIGUEZ, JOSE

Jose Rodriguez L.
(dropped down)

Baron ^o Von Smythe

Card typed: VON SMYTHE, ONE

Baron (dropped down)

When a German name appears with a small "v" between the given name and the surname, the Classifier is responsible to write out "Von" in the place of the small "v".

Example: Heinrich v. Smythe

should be written on the mail as: Heinrich ^o Von Smythe

Card typed: VON SMYTHE, HEINRICH

D. CHINESE AND JAPANESE NAMES

Chinese names are searched three ways if no part of the name is anglicized, however, only one card is made.

The Classifying Unit will circle all parts of the name of a main subject provided no part of the name is anglicized. Cross indexing will be indicated on but one part of the name.

Example:

If a portion of the name is capitalized or punctuated to indicate the surname, the card will be made on the indicated surname.

CHEN Tse Tung; CHEN, Tse-Tung; Chen, Tse Tung.

Above name will be circled by the Classifier on all three parts of the name but cross indexed on "CHEN" only.

The Main Card Searcher will search the name three ways. However, only one card will be made using "CHEN" as the surname.

CHEN, TSE TUNG (The hyphen should not appear on the card.)

If the name is not set out as above, the Classifier will again circle all parts of the name but cross index the last part of the name only.

Chen Tse Tung; Card made: TUNG, CHEN TSE

The Name Searcher must make a three-way search at all times. However, if the Main Card Searcher finds an ident main card on any part of the name, the search is stopped and the other two circles dotted. If the mail is new, a complete search must be made and the zip placed on the indicated surname only. The other circles should be X'd to indicate it is not necessary to make a card.

Example: °Chen °Tse °Tung - If an ident is found under TSE, TUNG CHEN the other two parts of the name may be dotted and not searched.

If part of the name is anglicized, such as CHEN WIN SMITH or JOHN CHEN WIN, only one card will be made on the last part of the name; i. e. SMITH, CHEN WIN and WIN, JOHN CHEN.

When an English surname is used, Classifying will circle only the English surname.

Examples of how names should be searched:

Chen Tse Tung	TUNG, CHEN TSE TSE, TUNG CHEN CHEN, TSE TUNG
---------------	--

Chen Win Smith	SMITH, CHEN WIN
----------------	-----------------

John Chen Win	WIN, JOHN CHEN CHEN, WIN JOHN
---------------	----------------------------------

The English given name would never be searched as a surname.

TWO-PART CHINESE NAMES:

If a two-part Chinese name is hyphenated it should be treated as follows:

Ping-Hsin	Card made: PING HSIN
-----------	----------------------

If no hyphen appears in a two part Chinese name, it will be made just like an English name:

Ping Hsin

Card made: HSIN, PING

TWO-PART SURNAME

At times in some Chinese names a two-part surname may be used. The two names may appear either with or without a hyphen. In these instances, two cards will be prepared. This will only apply when punctuation or capitalization indicates more than one surname.

Example: YONG JENG, Wo-Pu

Cards made: 1. YONG, WO PU

WO PU YONG JENG (dropped down)

2. JENG, WO PU YONG

Japanese names are generally two-part names. They will be circled on both parts of the name but cross indexed on only the last part (or the first part of the name if capitalized or punctuated to indicate the surname.) The searcher must search the names both ways. However, the Main Card Searcher may stop the search if an ident is found on either part of the name and dot the other circle. If the mail is new, a complete search must be made and the zip placed on the indicated surname only. The other circle should be X'd to indicate it is not necessary to make a card. Search will be made as follows:

Feiji Keiko

FEIJI, KEIKO

KEIKO, FEIJI

Card will be made

KEIKO, FEIJI

KEIJI, Teiko

KEIJI, TEIKO
TEIKO, KEIJI

Card will be made KEIJI, TEIKO

E. "BEN" NAMES

Names containing one given name and one surname set forth immediately after the "Ben" are classified on the "Ben" and not on the name following.

Examples: Efraim ^xBen Arzi

Card made: BEN ARZI, EFRAIM Filed: BENARZI behind "E" tab.

David ^xBen Gurion

Card made: BEN GURION, DAVID Filed: BENGURION behind "D" tab.

In those cases where there is an additional surname, each name following BEN will be classified as well as BEN.

Example: David ^xBen ^xHassen ^xSkurky

Cards made: BEN HASSEN, DAVID Filed: BENHASSEN behind "D" tab.
(complete name dropped down)
HASSEN, DAVID
(complete name dropped down)
SKURKY, DAVID BEN HASSEN

If the first name is not a known given name, the Classifier will index all ways and a card will be prepared on each name using it as a surname.

Example: ^xSukayl ^xBen ^xHassen ^xSkurky

Cards made: SUKAYL, BEN HASSEN SKURKY
BEN, HASSEN SKURKY SUKAYL
HASSEN, SKURKY SUKAYL BEN
SKURKY, SUKAYL BEN HASSEN

F. MIDDLE EAST AND NEAR EAST NAMES

(These include Jordan, Egypt, Iraq, Iran, countries of Arabian peninsula, India, Paktistan, etc.)

1. If the first name is not known, the classifier will index all names and a card will be prepared on each one using it as a surname.

Example: ^xAmin ^xKhazri ^xSeyed

Cards made: AMIN, KHAZRI SEYED
KHAZRI, SEYED AMIN
SEYED, AMIN KHAZRI

2. Two part names are indexed on both parts when the first name is not known and cards made on both parts.

Example: ^xParviz ^xTaherpour

Cards made: PARVIZ, TAHERPOUR
TAHERPOUR, PARVIZ

3. If one part of the name is a known given name, that part will not be indexed or searched.

Example: Abraham ^xMamed ^xGasam

Cards made: MAMED, GASAN ABRAHAM
GASAN, ABRAHAM MAMED

G. DOUBLE FOREIGN NAMES

Double foreign names which do not fall under the rules above are classified and cards made on both surnames.

Example: Heinrich ^xSchmidt ^xKahn

Cards made: SCHMIDT, HEINRICH
KAHN, HEINRICH SCHMIDT

H. SOVIET AND SATELLITE NAMES--"TER"

TER is in the position of a prefix but it is part of the surname and would never be used alone.

Example: FRANS ^oTER HORST

Card typed: TER HORST, FRANS

GIVEN AND SURNAMEN WHEN WRITTEN ALONE

On a given name or nickname that appears without a surname, no card is made on the name by itself, but a card is made combining the given name with the true surname of the subject.

Example: John ^xWilliamson, aka Henry ^xSmith, Skinnu

Cards made: (a) WILLIAMSON, JOHN
(b) SMITH, HENRY
(c) WILLIAMSON, SKINNY

When the full name is followed by a given name alias with an indication that the last name is unknown (LNU), no card will be made on the alias unless it can be determined that the alias is a code, spy, or stage name. However, the index card made on the complete name will contain a drop down showing the alias followed by LNU.

Example: Robert Bruce ^xCarter, aka Bert (LNU)

Card made: CARTER, ROBERT BRUCE

AKA: BERT (LNU)

Where there is an alias surname without a given name, the card is made by combining the true given name with the alias surname.

Example: John Henry ^xWilliamson, aka Harry ^xSmith, ^xJones

Cards made: (a) WILLIAMSON, JOHN HENRY
(b) SMITH, HARRY
(c) JONES, JOHN HENRY

Henry ^xHagen, aka ^xHagan, ^xHagne

Cards made: (a) HAGEN, HENRY
(b) HAGAN, HENRY
(c) HAGNE, HENRY

When the complete name is followed by a last name alias with an indication that the first name is unknown (FNU), a "One" card will be made on the last name alias.

Example: Richard Allen ^xMorris, aka (FNU) ^xMiller

Cards made: (a) MORRIS, RICHARD ALLEN
(b) MILLER, ONE

When numerous aliases appear, some with and some without given names, each instance where there is a surname without a given name, the given name of the true name is to be used with the surnames appearing alone.

Example: Henry ^xBlack, aka Harry ^xSmith, ^xBarton, John ^xBrown, ^xNaylor

Cards made: (a) BLACK, HENRY
(b) SMITH, HARRY
(c) BARTON, HENRY
(d) BROWN, JOHN
(e) NAYLOR, HENRY

Apply FNU and LNU rule to aliases of unknown subjects.

Example: Unknown Subject, aka Tom ^xWoods, Happy

Card made: WOODS, TOM

Unknown Subject, aka ^xMoore, ^xPete

Cards made: (a) MOORE, ONE
(b) PETE, ONE

Single code, spy, stage names, etc. should be made with "One."

Example: Henry ^xVon Hubert, code name ^x"Herbert."

Cards made: (a) VON HUBERT, HENRY
(b) HERBERT, ONE

HOUSE OF REPRESENTATIVES AND SENATE BILLS

All House of Representative Bills regardless of kind -- House Reports, Rules, Resolutions and Joint Resolutions -- will be made "H.R." with the number of the Bill, Rule, etc. on the top line. The same rule will apply to Senate Bills, but cards will be made "S." with the number of the Bill on the top line, with Bill, Resolution, Joint Resolution, etc. dropped two spaces to the body of the cards.

HYPHENATED NAMES

Hyphenated English names should be indexed as one word and filed as one word.

Example: James ^xSmith-John

Card made: SMITH-JOHN, JAMES Filed: SMITH-JOHN behind "J" tab.

Example: Henry ^xFoster-Smith
Typed: FOSTER-SMITH, HENRY

Filed: FOSTER-SMITH behind "H" tab.

Hyphenated foreign names should be indexed as two separate names:

Example: Jose ^xRodriquez^xLopez
Typed: LOPEZ, JOSE RODRIQUEZ
Typed: RODRIQUEZ, JOSE

Filed: LOPEZ behind "J" tab.

Filed: RODRIQUEZ behind "J" tab.

Example: Joseph ^xKahn-^xMeyer
Typed: MEYER, JOSEPH KAHN
Typed: KAHN, JOSEPH

Filed: MEYER behind "J" tab.

Filed: KAHN behind "J" tab.

When a foreign name appears with one part in parenthesis, the parenthesis should be ignored and names should be indexed as two separate names.

Example: Herman ^xMaltzoff ^x(Santisteban)

Typed: MALTZOFF, HERMAN

Filed: MALTZOFF behind "H" tab.

Typed: SANTISTEBAN, HERMAN MALTZOFF

Filed: SANTISTEBAN behind "H" tab.

If the name in parenthesis is found to be an alias from information on the mail, Classifying will indicate by using aka.

Example: John ^oZellner ^o(Weinrib)
aka

Typed: ZELLNER, JOHN

Filed: ZELLNER behind "J" tab.

Typed: WEINRIB, JOHN

Filed: WEINRIB behind "J" tab.

Obvious variation of a name will be treated as a separate surname.

Example: John ^xNevala^x(Nevola)

Typed: NEVALA, JOHN

Filed: NEVALA behind "J" tab.

Typed: NEVOLA, JOHN

Filed: NEVOLA behind "J" tab.

In corporate titles hyphenated names are indexed and filed as two words.

Example: ^xJones-Smith Company

Typed: JONES-SMITH COMPANY

Filed: JONES behind "S" tab.

AMERICAN INDIAN NAMES

Indian names will be circled and searched on all parts of the surname. However, if the Main Card Searcher finds an ident Main Card on the first part of the name, the search may be stopped and the other circles dotted. If the mail is new, the zip is placed on the first part of the name only, and the other circles should be x'ed to indicate it is not necessary to make the card. Cross indexing will be indicated on the first part of the surname only.

Example: (1) Charlie °Yellow °Thunder
Typed: YELLOW THUNDER, CHARLIE Filed: YELLOW THUNDER behind "C"
tab.

Example: (2) Mary °Little °White °Bear
Typed: LITTLE WHITE BEAR, MARY Filed: LITTLE WHITE BEAR behind
"M" tab.

Example: (3) Chief °Young °Tooth
Typed: YOUNG TOOTH, ONE (CHIEF DROPPED) Filed: YOUNG TOOTH, ONE
(before "A" tab.)

LICENSE NUMBERS

Cards on License numbers are filed with License as the first word. They are then filed behind the Government tab, the State tab, or the Foreign tab, and then in numerical order. All letters appearing with license numbers are disregarded in filing. License with no numbers are filed immediately before the State, Government or Foreign breakdown.

Example: License # AB4-568T Maryland
Typed: License # AB4-568T Maryland

Card Filed: License is filed first, Maryland is filed second, 4,568 is filed third.

MAIDEN NAMES

When a maiden name appears with a married name, both names will be classified and a card made with the given name and each last name.

and an additional card with all three names on the top line. Nicknames are made with the subject's current surname only.

Example: Helen ^xBriggs ^xRiley
Helen ^xBriggs ^x(Riley)
Helen ^xRiley, nee ^xBriggs

In each instance cards would be made as follows:

- (a) BRIGGS, HELEN
- (b) RILEY, HELEN
- (c) RILEY, HELEN BRIGGS

Example: Mary ^xSmith, nee ^xJones, nickname Susie

Cards made: (a) SMITH, MARY
(b) SMITH, MARY JONES
(c) JONES, MARY
(d) SMITH, SUSIE

If it cannot be determined from the mail that the individual is married and the middle name is a maiden name, only one card would be made.

Example: Evelyn Russell ^xLane

Card made: LANE, EVELYN RUSSELL

If former spouses also listed, the complete name with the nee name is made only with the current married name.

Example: Frances Ann Fry, nee Anderson
Formerly married to John Bruce

The complete name card would be made on FRANCES ANN ANDERSON FRY. No complete card is necessary on Frances Ann Anderson Bruce.

All cards prepared on a married female, should have dropped down as the "AKA," the complete name, consisting of given names, nee name and the current married name.

Example: Mary Jane Smith, nee Jones
Also known as: Mrs. Harry Smith,
Mary Smith, Mary Jane Lewis,
Mrs. George Lewis, Helen Martin,
Mildred Smith

Cards made: SMITH, MARY JANE
JONES, MARY JANE
SMITH, MARY JANE JONES
SMITH, HARRY MRS.

SMITH, MARY

LEWIS, MARY JANE
LEWIS, GEORGE MRS.

MARTIN, HELEN

SMITH, MILDRED

On all of the above cards (except the complete name card) the drop down "AKA" would be Mary Jane Jones Smith.

The above rules do not apply to female Spanish names. The Spanish drop down rule should be used.

MOTOR VEHICLE MOTOR NUMBERS

All cards on motor vehicle numbers are filed numerically regardless of the make of the vehicle. They will be made on VIN if given. If there is no VIN on the mail, use MOTOR NUMBER. When neither VIN nor MOTOR NUMBER is given use SERIAL NUMBER.

EXAMPLE:

N. S. P. T. MOTOR VEH.

^x FORD VIN 1GA, 235, 930	TYPED: FORD VIN 1GA, 235, 930 <u>1235930</u>	FILED: Under Motor Vehicle numerically 1, 235, 930
^x BUICK VIN 1 B0, 624	TYPED: BUICK VIN 1B0, 624 <u>10024</u>	FILED: Under Motor Vehicle 10, 624
^x CHEVROLET MOTOR NUMBER 108, 111	TYPED: CHEVROLET MN 108, 111	FILED: Under Motor Vehicle 108, 111

NAMES HAVING ONLY AN INITIAL FOR THE LAST NAME

Where only an initial is given in an English surname, combined with a given name, the card should be classified and typed with the given name and initial and filed by the given name and then the initial.

Example:	Typed:	Filed:
X Betty B.	BETTY B.	BETTY behind B tab.

NAMES (OR TITLES) OF BOOKS, ARTICLES, EDITORIALS, PROGRAMS, MOVIES, ETC.

Names (or titles) of the above are to be indexed and cards made exactly as they appear on the mail.

Example:

X "John Edgar Hoover, A Man Who Practices What He Preachers"
(editorial)

Typed:

JOHN EDGAR HOOVER, A MAN WHO PRACTICES WHAT HE PREACHES
(drop down and type "editorial")

Filed:

JOHN behind "E" tab.

EXAMPLE:

X "J. E. Hoover Warns Lax Parents"

Typed:

J. E. HOOVER WARNS LAX PARENTS (drop down and type "article")

Filed:

J behind "E" tab.

X Nick Carter-Master Detective (Radio Program)

Typed: NICK CARTER-MASTER DETECTIVE (drop down and type "Radio
Program")

Filed: NICK behind "C" tab.

DOUBLE NICKNAMES

If a double nickname or a name consisting of more than one word is crossed, put "ONE" on the subject matter line.

EXAMPLE: *Little Joe
CARD PREPARED: LITTLE JOE
EXAMPLE: *J. T.
 *BLACK JOE

CARD PREPARED:
J. T.
BLACK JOE

If initials, indicate by typing the word INITIALS on the title line.

NAMES OF FIRMS, ASSOCIATIONS, HOSPITALS, HOTELS, LIBRARIES, SCHOOLS, ETC.

All of the above will be indexed according to the Directory System.

Example:

JOHN J. *SMITH CO.

Typed: SMITH, JOHN J. COMPANY

Filed: SMITH behind "J" tab.

JAMES *MONROE ASSN.

Typed: MONROE, JAMES ASSOCIATION

Filed: MONROE behind "J" tab.

WOODROW *WILSON HOSPITAL

Typed: WILSON, WOODROW HOSPITAL

Filed: WILSON behind "W" tab.

NEWSPAPERS

Newspapers will be indexed as the name is quoted on the mail and the city and state of the publication dropped down.

Example:

1. El Paso, Texas Daily Star

Typed: EL PASO STAR

(drop down) Daily

El Paso, Texas

2. Times Herald of
Philadelphia, Pennsylvania

Typed: TIMES HERALD

(drop down) Philadelphia, Pa.

Searches of newspapers will be made in two ways i.e., with and without the city on the top line. Example 2 will be searched Times Herald and Philadelphia Times Herald.

NUMBERS

Numbers should be used as a secondary means of indexing, figures are used on items which carry a number.

Count three numbers starting from the right to left, ignoring all symbols, letters or dashes, then space once. If there is a symbol or a mark where you would space, then it is not necessary to space there. Use either spaces or commas. On anything that carries a serial number do not type the word serial on the subject matter line.

Example: # 50-6H1234

Typed: 5,0-6H1,234

Filed: 5,0-61,234

When numbers do not fall into the above type but are Titles or Proper Nouns, all numbers will be written out "One, Two, Three, Four, Five, Six, Seven, Eight, Nine and Naught." When "0" appears it should be written NAUGHT. "Zero" or other words that indicate "0" should never be used.

Example:

Preparation for War in 1940	Typed: PREPARATION FOR WAR IN ONE NINE FOUR NAUGHT
Toni 47 (Anonymous Communi.)	Typed: TONI FOUR SEVEN
First Baptist Church	Typed: ONE BAPTIST CHURCH
2849 (Anonymous Communication)	Typed: TWO EIGHT FOUR NINE
America First Committee	Typed: AMERICA ONE COMMITTEE
Twentieth Century Club	Typed: TWO NAUGHT CENTURY CLUB

PENITENTIARY, PENITENTIARIES, REFORMATORIES, JAILS

Penitentiary, Penitentiaries, Reformatories, Jails will be indexed under the name of the Penitentiary, Jail, Etc.

Example:

Card Prepared:	SAN QUENTIN PENITENTIARY
Card Filed:	SAN is filed as the first word, QUENTIN is filed second, PENITENTIARY is filed third.

If name does not appear in the mail, Penitentiary, Jail, etc. will be indexed and where it is located underlined. The STATE will be typed on the top line of the index card.

Example:

Card Prepared:	PENITENTIARY	STATE
Card Filed:	PENITENTIARY	behind the STATE tab.

PREFIXES

All prefixes should be filed as one word. They are typed however, as they appear on the mail. Example:

Trans-Atlantic Tours

Card made: Trans-Atlantic Tours

Filed: Transatlantic behind
T tab

Mid West News

Card made: Mid West News

Filed: Midwest behind N tab

Transatlantic Tours

Card made: Transatlantic Tours

Filed: Transatlantic behind
T tab

PREPOSITIONS, ARTICLES, AND CONJUNCTIONS

All prepositions and conjunctions are regarded in filing of cards. This includes "and", "of", "at", "to", etc. The articles "a", "an", and "the" are ignored.

QUOTATION MARKS

It is not necessary for typists to put quotation marks on any cards. This includes titles, pamphlets, nicknames, etc. The typists will continue to indicate in the body of the card when it is a pamphlet, book, ship, title, etc.

RELIGIOUS SURNAME OF X

These names will be classified in front of the "X" (or number of "X's" if more than one). The cards, however, will all be made with one "X" on the top line and the number of "X's" indicated by a drop down on the card.

Examples:

John ^x4 X Card typed: X, JOHN

John 4 X (Dropped down)

John ^xXXX Card typed: X, JOHN

John 3 X (Dropped down)

The cards will be filed in the "X" section of the Index in alphabetical order by the given name. For example all cards on John X, John XX and John 50X will be filed together. The searcher will be responsible to check the "drop down" for names with more than one "X".

on the same given name (with more than one "X" in the surname) the cards will be further broken down according to the number of "X's" on the drop down.

The "X" will be classified when it is preceded by a letter and the letter will be typed on the card as the middle initial. (Exception-- Name will be classified before the letter if the mail does not indicate that the individual is a member of the Muslim Cult of Islam.)

Examples: Henry J. ^xX

Card typed: X, Henry J.

Edward B. ^xX

Card typed: X, Edward B.

At times the "X" will appear between the given name and the surname. In these cases a card will be made on the "X" as well as the surname.

Examples: John ^x4X ^xMorgan

Cards typed: A. X, JOHN

(dropped down) John 4X Morgan

B. MORGAN, JOHN

(dropped down) John 4X Morgan

James A. ^xX ^xMorgan

Cards typed: A. X, JAMES A.

(dropped down) James AX Morgan

B. MORGAN, JAMES A.

(dropped down) James AX Morgan

TELEPHONE NUMBERS

All telephone numbers should be indexed and filed under "Telephone" with the number on the top line. They will be filed numerically according to number at the beginning of the "Telephone" breakdown.

Example: Republic 7100

Typed: TELEPHONE # 7100

Filed: TELEPHONE before "A" tab.

(drop down two spaces
and type the exchange
on the card)

Example: Telephone Code 501-532-7721

Typed: TELEPHONE # 5,32-7,721 Filed: Before "A" tab-omit code #

SISTER ^xMARY MARGARET

Typed: MARY MARGARET Filed: MARY behind "M" tab.

Sister

SISTER LOUISE ^xFISHER

Typed: FISHER, LOUISE Filed: FISHER behind "L" tab.

Sister

The proper arrangement of the cards filed before the A tab will be as follows:

PIEK
PIER, ONE
PIEK #

The rule for placing Mrs. on the top line when a woman uses her husband's name is shown below:

MRS. JOHN ^xJONES

Typed: JONES, JOHN MRS.

FRAU WILHELM HEINRICH

Typed: HEINRICH, WILHELM MRS.

All well-known foreign titles meaning Mr., Mrs., and Miss may be dropped from the cards entirely, except in cases where it is necessary to indicate gender - then the title is translated.

Example:

Senora Jose Lopez

Card made: LOPEZ, JOSE MRS.

When it is possible for the typist to definitely determine from the mail that an abbreviation stands for a foreign title, the title should be typed on the card in its proper place. If the typist cannot determine that the abbreviation stands for a foreign title, the card should be prepared as the name appears on the mail and filed as if the abbreviation were a given name. A card prepared "WEBER,

8/5/75 request

III - J

POLICIES AND PROCEDURES OF THE FBI
FOR THE USE OF FBI AGENTS FOR SO-CALLED
"UNDERCOVER" ACTIVITY

RETAIN

NATIONAL SECURITY INFORMATION
Unauthorized Disclosure
Subject to Criminal Sanctions

274-10128

UNITED STATES GOVERNMENT

Memorandum

TO : Mr. E. S. Miller

CONFIDENTIAL DATE: 9/8/72

FROM : R. L. Shackelford *RS*

SUBJECT: *0* REVOLUTIONARY ACTIVITIES - VIOLENCE
INTERNAL SECURITY - REVOLUTIONARY ACTIVITIES

Felt	_____
Baker	_____
Bates	_____
Bishop	_____
Callahan	_____
Cleveland	_____
Conrad	_____
Dalbey	_____
Jenkins	_____
Marshall	_____
Miller, E.S.	_____ <input checked="" type="checkbox"/>
Ponder	_____
Soyars	_____
Walters	_____
Tele. Room	_____
Mr. Kinley	_____
Mr. Armstrong	_____
Ms. Herwig	_____
Mrs. Neenan	_____

Est
PURPOSE:

To obtain Mr. Gray's approval of the attached "Working Guide for Utilization of Undercover Special Agents."

DETAILS:

To insure our sensitive operations involving undercover Agents are afforded uniform maximum security at FBIHQ and in the field, it is believed essential the attached guide be made available to select Special Agents in Charge (SACs) who may be involved in these operations. The attached includes correct and secure methods for submission of recommendations from the field, handling of files at FBIHQ and in the field and administrative procedures which must be considered and met securely and uniformly.

There is also a section included in the guide relating to responsibilities of the Inspection Staff during routine inspections of field offices. It is believed desirable that the Inspector personally handle these matters with the SAC, for example, and that a periodic independent evaluation of the Inspection Staff is a desirable check on these operations. The guide includes these provisions.

These guidelines have been carefully coordinated between Domestic Intelligence Division, Inspection Staff and knowledgeable field personnel.

RECOMMENDATIONS:

1. The attached guidelines be approved.

Enclosure
RLS:djr
(1)

REG-47

ST-112

RECOMMENDATIONS CONTINUED - 001

*File 134-23721
5-4011P*

CONFIDENTIAL

Memorandum to Mr. E. S. Miller
RE: REVOLUTIONARY ACTIVITIES - VIOLENCE
INTERNAL SECURITY - REVOLUTIONARY ACTIVITIES

RECOMMENDATIONS CONTINUED:

2. If approved, copies will be forwarded to appropriate SACs by Domestic Intelligence Division for implementation; and,

3. The Inspection Division will be furnished copies for use during inspection of appropriate field offices.

aw

[Handwritten signature]

[Handwritten signature]

[Handwritten signature]

[Handwritten signature]

[Handwritten signature]

[Handwritten signature]

[Handwritten signature]

[Handwritten signature]
DmAs

[Handwritten signature]

1, 2, 3 approved.

[Handwritten signature]
10/9
3:14P

CONFIDENTIAL

WORKING GUIDE FOR UTILIZATION OF
UNDERCOVER SPECIAL AGENTS

CONFIDENTIAL

A. Predication

There are presently over 50 men and women fugitives who are believed involved in the underground apparatus, over 25 of whom are Weatherman affiliated, based on violations of Antiriot Law, Federal Bombing and Gun Control statutes, Sabotage and for various local violations where UFAP process has been issued. In addition to these fugitives being in an underground status, there are also a considerable number of missing Weatherman who are supporting fugitives from their underground status as well as over 200 individuals considered part of surface/support or legal Weatherman apparatus.

There are also many collectives, communes and other groups, more local in nature, while not directly affiliated with Weatherman, follow the basic Weatherman philosophy of violent revolution now and are willing and capable of participation in violent terroristic revolutionary activity against the existing Government structure of the nation.

B. Objectives

1. Penetration of Weatherman underground and that of other revolutionary groups or communes
 - a. Location and apprehension of Weatherman and other revolutionary fugitives
 - b. Neutralization of underground apparatus which will lead to stoppage of terrorist bombings and other violent revolutionary activity

C. Recommendations for Use of Agent
in These Assignments

1. Must have personal recommendation of SAC that Agent is physically and psychologically qualified for such an assignment
2. Must have specific target for penetration
3. Must have suitable cover identity
 - a. Assumed identity should include documentation such as birth certificate, social security card, draft card or discharge papers, driver's license, employment background, faked criminal record in a police department and should not be that of a real living person

- (CONFIDENTIAL)
- b. Cover identity, if necessary, would include rental of or ownership of suitable automobile, van or camper.
 - c. Cover identity, if necessary, would include rental of suitable apartment or "pad" in appropriate neighborhood
4. Agent must be assigned code name which will be utilized when necessary in contacts with handling Agent
 5. Initial communication recommending Agent for particular assignment will be carried under newly assigned symbol number followed by letter S and word (Extremist) and submitted in coded teletype
 6. Review of recommendation will be made at FBIHQ by appropriate supervisor and recommendation by Revolutionary Activities Section submitted in a memorandum for approval

D. Security

1. At FBIHQ

- a. Assignment of symbol numbers which will be utilized in all communications. True name will only be set out in body of initial coded teletype to FBIHQ under symbol number caption
- b. 134 informant file will be opened on each Agent approved
- c. A 134 control file will be maintained which contains this document and other general instructions which apply to undercover operations
- d. These 134 files will be maintained in locked bar cabinet in Revolutionary Activities Section
- e. Teletype Room will place Route in Envelope on all incoming teletypes which carry symbol number in caption
- f. Route in Envelope will be placed on all communications concerning Agent in this assignment even though symbol number caption is used
- g. Memorandum under Agent's name will be prepared for his personnel file noting he is on special assignment and information concerning this assignment is maintained in 134-_____. Section Chief, Revolutionary Activities Section is to be called for such information
- h. A caution will be placed with movement unit and payroll records that any inquiries received concerning any agent is an undercover assignment will be referred to Section Chief, Revolutionary Activities Section

2. In Field

CONFIDENTIAL

- a. A 134 file on undercover Agent is to be maintained in secure condition under control of appropriate supervisor
- b. A 134 control file will be maintained which contains this document and other general instructions which apply to undercover operations
- c. Information concerning Agent's assignment is to be made available on a need-to-know basis only
- d. Each undercover Agent is to have a handling Agent who will receive pertinent information from him telephonically or in person, if necessary. This information should be recorded in the 134 file in accordance with existing instructions for recording information from informants. FD-302 should be utilized where appropriate
- e. Handling Agent should personally contact the undercover Agent, preferably weekly, to assess his progress toward stated target and prepare memorandum for 134 file describing performance and progress of undercover Agent
- f. The weekly assessment of the contacting Agent should be reviewed by the SAC and utilized in preparation of a monthly communication to the Bureau under appropriate symbol number caption. Detailed instructions as to content and submission date will be handled separately
- g. SAC, or in his extended absence ASAC, at frequent intervals not in any instance to exceed 60 days, should arrange to personally meet with the undercover Agent, away from the office and under secure conditions, to personally assess the mental and physical welfare and condition of the Agent. The field official should coordinate closely with contacting Agent and satisfy himself the undercover Agent's productivity, motivation, attitude and direction are consistent with the Bureau's interests and within the objectives of that office in recommending utilization of the Agent in this assignment. Do not overlook the possibility of arranging a physical examination of the Agent if it appears warranted. The SAC, or ASAC, should record this contact in the field 134 file

E. Inspection Matters

The Inspector is to personally handle this phase of inspections (or if absolutely essential the Number One Man). There should be no discussion among the Inspection Staff of these matters. After an inspection begins, the Inspector will receive from the office of the Assistant Director, Inspection Division, a write-up identifying the undercover operations in existence in the office. Early in the inspection the following should be done:

1. Review the undercover Agent's 134 file in the field
2. Review pertinent substantive files that show results of the undercover operation

CONFIDENTIAL

CONFIDENTIAL

3. Discuss with the SAC what administrative devices are in existence. This includes any written instructions to the undercover Agents, the method used by the office in contacting the Agent and the method used by the Agent in contacting the office. Also, review reports or other communications submitted by the undercover Agent which account for his activities and whereabouts
4. Review the security procedures in effect in the office to assure that all logical precautions are being taken. Determine the reasonableness of the cover being used by the Agent and steps taken to document his cover story. Check for conformity to the general guidelines contained in the other sections of this working guide
5. Interview the undercover Agent. The SAC should be requested to arrange for the time and place of the meeting so that it will be afforded maximum security and introduce the Inspector to the Agent. It is realized that there may be rare instances when it will not be feasible to interview an undercover Agent during an inspection. This could occur if the individual was involved in a highly active situation and security of the operation could be jeopardized if the undercover Agent broke away in order to meet the Inspector. Undercover Agents should not be called in from annual leave for a routine interview
6. During the interview probe for potential trouble areas, as well as examine the overall value of the operation. Your interview should include but not necessarily be limited to the following points:
 - a. Is the Agent satisfied with his assignment?
 - b. Is he encountering any personal difficulties which could affect his future usefulness on this assignment? Does he have any family problems which have a bearing on his assignment?
 - c. Does he understand the objective of his assignment and is he making progress in accomplishing it? Does he have any suggestions to further improve the program or to increase his chance of success in accomplishing his mission?
7. At the conclusion of the interview, prepare a memorandum from you to the SAC for each undercover Agent in the office whether or not interviewed. This memo should be in duplicate and should be captioned with the undercover Agent's symbol number. Do not refer to him by name, use phrase "the source or the informant." Include in the memo the following:

CONFIDENTIAL

CONFIDENTIAL

- a. The date of the interview and by whom. If the undercover Agent was not interviewed, so state and the reason
- b. The nature of the undercover operation in general terms, i.e., why the operation is in effect in the field office and what it is supposed to accomplish
- c. A brief description of how the undercover activity operates and the administrative controls that are in effect
- d. Comments regarding the suitability of the individual undercover Agent, including any difficulties he is encountering in this assignment
- e. Suggestions the Agent or Inspector might have for improving any aspect of the undercover operation
- f. A specific recommendation by the Inspector concerning:
 - (1) Whether the Agent should be continued in this assignment
- g. Comments of SAC should be requested

8. In the event the Inspector feels it is necessary to prepare a memorandum concerning the general operation of Agents undercover in a division, a memorandum under a caption using appropriate symbol numbers of the personnel should be utilized with copies designated for the appropriate 134 files in the field office including the 134 control file.

After the SAC puts his addendum on the memo, the original memo with addendum should be left with the SAC for filing in the 134 file in the field office. The duplicate memo with SAC's addendum should be placed in a sealed envelope and sent to Assistant Director, Inspection Division. After review, it will be sent to the Domestic Intelligence Division where it will be filed in the 134 file maintained in that Division after any necessary action is taken. Under no circumstances are any copies to be made of this memo except the one copy indicated above. The undercover operation and the undercover Agents are not to be commented on in any place in the inspection work papers, write-ups, or letter. Appropriate comments concerning an undercover operation may be included in the inspection summary prepared for The Director.

The Inspector should discuss with Assistant Director, Inspection Division, any problems you encounter in this phase of the inspection.

F. Funds

1. Normally accrued expenses will be claimed from confidential fund. Blue slip submitted for these expenses must show Agent's symbol number followed by word (Extremist) and his code name
2. Symbol number and code name are available to Voucher-Statistical Section, Confidential Funds, for their use when blue slips are submitted

CONFIDENTIAL

- (CONFIDENTIAL)
3. Receipts will be obtained where practical and Bureau authority requested in the event of unusual or out of the ordinary expenses are incurred in connection with operation.
 4. Per diem accrued while on this assignment and travel expenses incurred in connection with same may be claimed on regularly submitted monthly expense voucher. If receipt obtained under assumed identity, SAC, or note attached to voucher, will stipulate no receipts attached due to confidential nature of assignment, adding he reviewed receipts and found them to be accurate. If applicable, SAC should also stipulate nature of assignment precluded use of GTR

G. Safeguards

1. Bureau property of Agents on these assignments is not to be maintained on their person or premises and such property should be maintained securely in office of SAC
 - a. Where circumstances warrant it in the personal judgment of the SAC, an appropriate firearm and credentials may be issued to the Agent on covert assignment while these circumstances exist
2. If arrested while on assignment by local authorities and Agent and others in his group are represented by an attorney, Agent should not report on the attorney-client relationship of others involved in such an arrest. To withdraw from the attorney-client relationship would draw immediate attention and suspicion to the Agent
3. Care should be given to arranging the Agent's personal finances (paycheck, bonds, etc.) and correspondence matters consistent with the Agent's cover and in a manner adequate to insure his safety
4. A Stop Index File entry under Security Activities caption has been personally placed with the Assistant Director, Computer Systems Division, under symbol number and assumed name (cover identity) of Agent. If a local law enforcement agency makes an inquiry about the Agent under his assumed name, it will be advised we have no information concerning this individual; however, Section Chief, Revolutionary Activities Section, will be immediately advised and appropriate action taken

H. Administrative Matters

CONFIDENTIAL

1. Monthly Administrative Report

SAC Letter 70-20 (A), dated 4/14/70, sets forth instructions and guidelines as to total number of Agents with General Investigative assignments and total number of Agents with No Matters Assigned as reported on Monthly Administrative Report. Under number two category Agents on special assignment are included. Accordingly, Agents in undercover operations are to be included in this category. The Inspector or Number One Man will handle these individuals on inspections. Manual of Rules and Regulations, Part II, Section 3, page 20a, requires details supporting entries in this category on file copy. Concerning Agents in this assignment supportive material will only be comment, "see 134 (file on Agent)."

2. Maintenance of records

- a. To preclude unnecessary exposure of records pertaining to these Agents, the Agents should be assigned to the SAC where practical
- b. The contacting Agent should satisfy himself the undercover Agent is productively engaged on a full time basis and is performing at least the minimally required (fringe) 108 minutes per day overtime daily (it being recognized in most instances this is virtually a 24 hour per day, seven days a week assignment). These observations are to be included in the weekly memorandum (D, 2, d, supra) submitted by the contacting Agent
- c. Necessary data for completion of the time and attendance records of the undercover Agent should be furnished the SAC's secretary for processing
- d. Upon review of pertinent 134 file, specifically weekly memorandum of contacting Agent, SAC will certify undercover Agent for fringe unless facts do not warrant it
- e. In most instances, practical consideration of these assignments will preclude use of #1 Register and FD-256 (#3 locate card) by personnel in these assignments

CONFIDENTIAL

I. General Comments

CONFIDENTIAL

1. The security and well being of personnel involved in these special assignments are of paramount interest to all parties, FBIHQ, field personnel and the Inspection Staff
2. The above guidelines are intended for guidance and it is expected that good judgment in adhering to them will be utilized bearing in mind Item 1 above
3. Again bearing in mind Item 1 above, it is expected these operations will be handled on a strictly need-to-know basis and under tight security

CONFIDENTIAL

Confidential

airtel

- 1 - Mr. E. S. Miller
- 1 - Mr. R. L. Shackelford
- 1 - Mr. T. J. McNiff

10/12/72

To: SACs Albany Philadelphia
 Boston Phoenix
 Chicago Portland
 Cleveland St. Louis
 Denver San Diego
 Detroit San Francisco
 Los Angeles Seattle
 Milwaukee Springfield
 New York Washington Field

PERSONAL ATTENTION

- 1 - Mr. F. B. Griffith
- 1 - Mr. W. N. Preusse

From: Acting Director, FBI

REVOLUTIONARY ACTIVITIES - VIOLENCE
IS - REVOLUTIONARY ACTIVITIES

Attached for each office is a copy of "Working Guide for Utilization of Undercover Special Agents." This working guide is being furnished recipients as you either have Agents involved in undercover assignments, are contemplating such assignments in the near future or have potential targets, but no qualified Agents for these assignments at this time. This working guide is to be carefully reviewed by you and appropriate supervisor to insure your responsibilities and administrative procedures in these matters are met securely and uniformly.

As noted on page 3, item 23 of the working guide a 134 control file will be maintained by each office which will contain this document and other general instructions which apply to undercover operations. This control file must be afforded the same security as the individual 134 file maintained on Agents assigned in undercover operations. For your guidance the following headquarters communications previously sent should also be included in 134 control file:

Enclosure Classified by 7225
 Exempt from GDS, Category 2
 Date of Declassification Indefinite
1/27/75 TJM

ST 100

REC-69 134-23721-47

SEE NOTE PAGE TWO

~~100-446777-15-31~~

15 OCT 12 1972

MAILED 5
 OCT 12 1972

WNP:crk
 (42) *crk*

ENCLOSURE

ROUTE IN ENVELOPE

- Felt _____
- Baker _____
- Bates _____
- Bishop _____
- Callahan _____
- Cleveland _____
- Conrad _____
- Dalbey _____
- Jenkins _____
- Marshall _____
- Miller, E.S. _____
- Ponder _____
- Soyars _____
- Walters _____
- Tele. Room _____
- Mr. Kinley _____
- Mr. Armstrong _____

1/27/75
R/S to recipients + BU
to classify airtel
TJM

SC

gp

RLS

WNT

Confidential

Airtel to Albany, Et Al

Re: Revolutionary Activities - Violence

1. Bureau teletype, to all recipients except Phoenix, 7/24/72 captioned "Students for a Democratic Society (SDS) (Weatherman)"
2. Bureau teletype to Denver, 8/10/72 captioned "Revolutionary Activities - Violence (RA-V)"
3. Bureau teletype to Albany, 8/10/72 captioned "RA-V"
4. " " to Portland, 8/10/72 captioned "RA-V"
5. " " to St. Louis, 8/10/72 captioned "RA-V"
6. " " to Phoenix, 8/11/72 captioned "RA-V"
7. " " to Springfield, 8/14/72 captioned "RA-V"
8. " " to Chicago, 8/14/72 captioned "RA-V"
9. " " to Cleveland, 8/14/72 captioned "RA-V"
10. " " to Washington Field, 8/14/72 captioned "RA-V"
11. " " to Detroit, 8/14/72, captioned "RA-V"
12. Phoenix teletype, 7/25/72 captioned "SDS (Weatherman)"
13. Bureau airtel to Boston, Los Angeles, Milwaukee, New York, Philadelphia, Phoenix, San Diego, San Francisco and Seattle, 8/23/72 captioned "RA-V"
14. Bureau airtel to Philadelphia, 8/23/72 captioned "SDS (Weatherman)"
15. Bureau teletype to Washington Field, 8/24/72 captioned "SDS (Weatherman)"
16. Bureau teletype to Boston, Los Angeles, Milwaukee, New York, Philadelphia, Phoenix, San Diego, San Francisco and Seattle, 8/24/72 captioned "RA-V"
17. Bureau teletype to Albany, 8/24/72 captioned "RA-V"
18. Washington Field teletype, 8/25/72 captioned "SDS (Weatherman)"
19. Philadelphia airtel, 8/28/72 captioned "SDS (Weatherman)"
20. Chicago teletype, 8/29/72 captioned "SPECTAR, RA-V"
21. Bureau teletype to Chicago, 9/5/72 captioned "SPECTAR, RA-V"

NOTE:

This working guide was approved by Mr. Gray on 10/9/72.

Confidential

Confidential

WORKING GUIDE FOR UTILIZATION OF
UNDERCOVER SPECIAL AGENTS

A. Predication

There are presently over 50 men and women fugitives who are believed involved in the underground apparatus, over 25 of whom are Weatherman affiliated, based on violations of Antiriot Law, Federal Bombing and Gun Control statutes, Sabotage and for various local violations where UFAP process has been issued. In addition to these fugitives being in an underground status, there are also a considerable number of missing Weatherman who are supporting fugitives from their underground status as well as over 200 individuals considered part of surface/support or legal Weatherman apparatus.

There are also many collectives, communes and other groups, more local in nature, while not directly affiliated with Weatherman, follow the basic Weatherman philosophy of violent revolution now and are willing and capable of participation in violent terroristic revolutionary activity against the existing Government structure of the nation.

B. Objectives

1. Penetration of Weatherman underground and that of other revolutionary groups or communes
 - a. Location and apprehension of Weatherman and other revolutionary fugitives
 - b. Neutralization of underground apparatus which will lead to stoppage of terrorist bombings and other violent revolutionary activity

C. Recommendations for Use of Agent
in These Assignments:

1/27/75 Classified by 7225
TJM Exempt from GDS, Category 2
Date of Declassification Indefinite

1. Must have personal recommendation of SAC that Agent is physically and psychologically qualified for such an assignment
2. Must have specific target for penetration
3. Must have suitable cover identity
 - a. Assumed identity should include documentation such as birth certificate, social security card, draft card or discharge papers, driver's license, employment background, ~~and~~ ^{and} ~~no~~ ^{no} criminal record in a police department and should not be that of a real living person

Confidential

- b. Cover identity, if necessary, would include rental of or ownership of suitable automobile, van or camper.
- c. Cover identity, if necessary, would include rental of suitable apartment or "pad" in appropriate neighborhood.
4. Agent must be assigned code name which will be utilized when necessary in contacts with handling Agent
5. Initial communication recommending Agent for particular assignment will be carried under newly assigned symbol number followed by letter S and word (Extremist) and submitted in coded teletype
6. Review of recommendation will be made at FBIHQ by appropriate supervisor and recommendation by Revolutionary Activities Section submitted in a memorandum for approval

D. Security

1. At FBIHQ

- a. Assignment of symbol numbers which will be utilized in all communications. True name will only be set out in body of initial coded teletype to FBIHQ under symbol number caption
- b. 134 informant file will be opened on each Agent approved
- c. A 134 control file will be maintained which contains this document and other general instructions which apply to undercover operations
- d. These 134 files will be maintained in locked bar cabinet in Revolutionary Activities Section
- e. Teletype Room will place Route in Envelope on all incoming teletypes which carry symbol number in caption
- f. Route in Envelope will be placed on all communications concerning Agent in this assignment even though symbol number caption is used
- g. Memorandum under Agent's name will be prepared for his personnel file noting he is on special assignment and any information concerning this assignment is maintained in 134- . Section Chief, Revolutionary Activities Section is to be called for such information
- h. A caution will be placed with movement unit and payroll records that any inquiries received concerning any Agent is an undercover assignment will be referred to Section Chief, Revolutionary Activities Section

CONFIDENTIAL

Confidential

2. In Field

- a. A 134 file on undercover Agent is to be maintained in secure condition under control of appropriate supervisor
- b. A 134 control file will be maintained which contains this document and other general instructions which apply to undercover operations
- c. Information concerning Agent's assignment is to be made available on a need-to-know basis only
- d. Each undercover Agent is to have a handling Agent who will receive pertinent information from him telephonically or in person, if necessary. This information should be recorded in the 134 file in accordance with existing instructions for recording information from informants. FD-302 should be utilized where appropriate
- e. Handling Agent should personally contact the undercover Agent, preferably weekly, to assess his progress toward stated target and prepare memorandum for 134 file describing performance and progress of undercover Agent
- f. The weekly assessment of the contacting Agent should be reviewed by the SAC and utilized in preparation of a monthly communication to the Bureau under appropriate symbol number caption. Detailed instructions as to content and submission date will be handled separately
- g. SAC, or in his extended absence ASAC, at frequent intervals not in any instance to exceed 60 days, should arrange to personally meet with the undercover Agent, away from the office and under secure conditions, to personally assess the mental and physical welfare and condition of the Agent. The field official should coordinate closely with contacting Agent and satisfy himself the undercover Agent's productivity, motivation, attitude and direction are consistent with the Bureau's interests and within the objectives of that office in recommending utilization of the Agent in this assignment. Do not overlook the possibility of arranging a physical examination of the Agent if it appears warranted. The SAC, or ASAC, should record this contact in the field 134 file

E. Inspection Matters

The Inspector is to personally handle this phase of inspections (or if absolutely essential the Number One Man). There should be no discussion among the Inspection Staff of these matters. After an inspection begins, the Inspector will receive from the office of the Assistant Director, Inspection Division, a write-up identifying the undercover operations in existence in the office. Early in the inspection the following should be done:

1. Review the undercover Agent's 134 file in the field
2. Review pertinent substantive files that show results of the undercover operation

Confidential

3. Discuss with the SAC what administrative devices are in existence. This includes any written instructions to the undercover Agents, the method used by the office in contacting the Agent and the method used by the Agent in contacting the office. Also, review reports or other communications submitted by the undercover Agent which account for his activities and whereabouts
4. Review the security procedures in effect in the office to assure that all logical precautions are being taken. Determine the reasonableness of the cover being used by the Agent and steps taken to document his cover story. Check for conformity to the general guidelines contained in the other sections of this working guide
5. Interview the undercover Agent. The SAC should be requested to arrange for the time and place of the meeting so that it will be afforded maximum security and introduce the Inspector to the Agent. It is realized that there may be rare instances when it will not be feasible to interview an undercover Agent during an inspection. This could occur if the individual was involved in a highly active situation and security of the operation could be jeopardized if the undercover Agent broke away in order to meet the Inspector. Undercover Agents should not be called in from annual leave for a routine interview
6. During the interview probe for potential trouble areas, as well as examine the overall value of the operation. Your interview should include but not necessarily be limited to the following points:
 - a. Is the Agent satisfied with his assignment?
 - b. Is he encountering any personal difficulties which could affect his future usefulness on this assignment? Does he have any family problems which have a bearing on his assignment?
 - c. Does he understand the objective of his assignment and is he making progress in accomplishing it? Does he have any suggestions to further improve the program or to increase his chance of success in accomplishing his mission?
7. At the conclusion of the interview, prepare a memorandum from you to the SAC for each undercover Agent in the office whether or not interviewed. This memo should be in duplicate and should be captioned with the undercover Agent's symbol number. Do not refer to him by name, use phrase "the source or the informant." Include in the memo the following:

Confidential

- a. The date of the interview and by whom. If the undercover Agent was not interviewed, so state and the reason
- b. The nature of the undercover operation in general terms, i.e., why the operation is in effect in the field office and what it is supposed to accomplish
- c. A brief description of how the undercover activity operates and the administrative controls that are in effect
- d. Comments regarding the suitability of the individual undercover Agent, including any difficulties he is encountering in this assignment
- e. Suggestions the Agent or Inspector might have for improving any aspect of the undercover operation
- f. A specific recommendation by the Inspector concerning:
(1) Whether the Agent should be continued in this assignment
- g. Comments of SAC should be requested

8. In the event the Inspector feels it is necessary to prepare a memorandum concerning the general operation of Agents undercover in a division, a memorandum under a caption using appropriate symbol numbers of the personnel should be utilized with copies designated for the appropriate 134 files in the field office including the 134 control file.

After the SAC puts his addendum on the memo, the original memo with addendum should be left with the SAC for filing in the 134 file in the field office. The duplicate memo with SAC's addendum should be placed in a sealed envelope and sent to Assistant Director, Inspection Division. After review, it will be sent to the Domestic Intelligence Division where it will be filed in the 134 file maintained in that Division after any necessary action is taken. Under no circumstances are any copies to be made of this memo except the one copy indicated above. The undercover operation and the undercover Agents are not to be commented on in any place in the inspection work papers, write-ups, or letter. Appropriate comments concerning an undercover operation may be included in the inspection summary prepared for The Director.

The Inspector should discuss with Assistant Director, Inspection Division, any problems you encounter in this phase of the inspection.

F. Funds

1. Normally accrued expenses will be claimed from confidential fund. Blue slip submitted for these expenses must show Agent's symbol number followed by word (Extremist) and his code name
2. Symbol number and code name are available to Voucher-Statistical Section, Confidential Funds, for their use when blue slips are submitted

Confidential

3. Receipts will be obtained where practical and Bureau authority requested in the event of unusual or out of the ordinary expenses are incurred in connection with operation
4. Per diem accrued while on this assignment and travel expenses incurred in connection with same may be claimed on regularly submitted monthly expense voucher. If receipt obtained under assumed identity, SAC, on note attached to voucher, will stipulate no receipts attached due to confidential nature of assignment, adding he reviewed receipts and found them to be accurate. If applicable, SAC should also stipulate nature of assignment precluded use of GTR

G. Safeguards

1. Bureau property of Agents on these assignments is not to be maintained on their person or premises and such property should be maintained securely in office of SAC
 - a. Where circumstances warrant it in the personal judgment of the SAC, an appropriate firearm and credentials may be issued to the Agent on covert assignment while these circumstances exist
2. If arrested while on assignment by local authorities and Agent and others in his group are represented by an attorney, Agent should not report on the attorney-client relationship of others involved in such an arrest. To withdraw from the attorney-client relationship would draw immediate attention and suspicion to the Agent
3. Care should be given to arranging the Agent's personal finances (paycheck, bonds, etc.) and correspondence matters consistent with the Agent's cover and in a manner adequate to insure his safety
4. A Stop Index*File entry under Security Activities caption has been personally placed with the Assistant Director, Computer Systems Division, under symbol number and assumed name (cover identity) of Agent. If a local law enforcement agency makes an inquiry about the Agent under his assumed name, it will be advised we have no information concerning this individual; however, Section Chief, Revolutionary Activities Section, will be immediately advised and appropriate action taken

Confidential

Confidential

H. Administrative Matters

1. Monthly Administrative Report

SAC Letter 70-20 (A), dated 4/14/70, sets forth instructions and guidelines as to total number of Agents with General Investigative assignments and total number of Agents with No Matters Assigned as reported on Monthly Administrative Report. Under number two category Agents on special assignment are included. Accordingly, Agents in undercover operations are to be included in this category. The Inspector or Number One Man will handle these individuals on inspections. Manual of Rules and Regulations, Part II, Section 3, page 20a, requires details supporting entries in this category on file copy. Concerning Agents in this assignment supportive material will only be comment, "see 134 (file on Agent)."

2. Maintenance of records

- a. To preclude unnecessary exposure of records pertaining to these Agents, the Agents should be assigned to the SAC where practical
- b. The contacting Agent should satisfy himself the undercover Agent is productively engaged on a full time basis and is performing at least the minimally required (fringe) 108 minutes per day overtime daily (it being recognized in most instances this is virtually a 24 hour per day, seven days a week assignment). These observations are to be included in the weekly memorandum (D, 2, d, supra) submitted by the contacting Agent
- c. Necessary data for completion of the time and attendance records of the undercover Agent should be furnished the SAC's secretary for processing
- d. Upon review of pertinent 134 file, specifically weekly memorandum of contacting Agent, SAC will certify undercover Agent for fringe unless facts do not warrant it
- e. In most instances, practical consideration of these assignments will preclude use of #1 Register and FD-256 (#3 locate card) by personnel in these assignments

Confidential

Confidential

I. General Comments

1. The security and well being of personnel involved in these special assignments are of paramount interest to all parties, FBIHQ, field personnel and the Inspection Staff
2. The above guidelines are intended for guidance and it is expected that good judgment in adhering to them will be utilized bearing in mind Item 1 above
3. Again bearing in mind Item 1 above, it is expected these operations will be handled on a strictly need-to-know basis and under tight security

Confidential

Confidential

airtel

- 1 - Mr. E. S. Miller
- 1 - Mr. R. L. Shackelford
- 1 - Mr. T. J. McNiff

11/24/72

To: SACs Albany (Enc.) Philadelphia (Enc.)
 Boston (Enc.) Phoenix (Enc.)
 Chicago (Enc.) Portland (Enc.) PERSONAL ATTENTION
 Cleveland (Enc.) St. Louis (Enc.)
 Denver (Enc.) San Diego (Enc.) 1 - Mr. F. B. Griffith
 Detroit (Enc.) San Francisco (Enc.) 1 - Mr. W. N. Preusse
 Los Angeles (Enc.) Seattle (Enc.)
 Milwaukee (Enc.) Springfield (Enc.)
 New York (Enc.) Washington Field (Enc.)

ST
11/27/72
11/25/72
11/24/72
11/23/72
11/22/72
11/21/72
11/20/72
11/19/72
11/18/72
11/17/72
11/16/72
11/15/72
11/14/72
11/13/72
11/12/72
11/11/72
11/10/72
11/9/72
11/8/72
11/7/72
11/6/72
11/5/72
11/4/72
11/3/72
11/2/72
11/1/72

From: For the Acting Director, FBI
 W. Mark Felt
 Acting Associate Director

REVOLUTIONARY ACTIVITIES - VIOLENCE
 IS - REVOLUTIONARY ACTIVITIES

Re Bureau airtel 10/12/72 and its enclosure "Working Guide for Utilization of Undercover Special Agents."

Enclosed is a revised copy of the working guide. Copy sent 10/12/72 is to be destroyed and replaced with revised copy.

Your attention is called to the following changes in the working guide and should carefully be reviewed by you and appropriate supervisors to insure your responsibilities and administrative procedures in these matters are met securely and uniformly.

Your particular attention is called to Item 2b on page 8. You must insure that the proper form and certification is made regarding undercover Agent's overtime status.

Page 1, Modification

Page 1, Copy 129785

NOV 24 1972
 FBI

Confidential

ST-113

134-23721

WMB:ark
 (42)

SEE NOTE PAGE TWO

REC-47

134-23721-6

ENCLOSURE

DEC 12 1972

ROUTE IN ENVELOPE

- Tolson
- DeLoach
- Mohr
- Bishop
- Casper
- Callahan
- Conrad
- Felt
- Gale
- Rosen
- Sullivan
- Tavel
- Trotter
- Tele. Room
- Holmes
- Gandy

Confidential

Airtel to Albany, Et Al
Re: Revolutionary Activities - Violence

Page 1, Item C 3a
Page 2, Item C 5
Page 2, Item D 1a
Page 3, Item D 2f
Page 3, Item D 2g
Page 3, Item D 2h
Pages 6, 7, Item F all matters
Page 8, Item H 2b
Page 9, Item I 4

NOTE:

Changes in working guide have been previously approved by headquarters officials. Changes were sent to appropriate offices by teletype and are now being incorporated in working guide. It is noted some of changes are made to clarify questions raised by field.

Confidential

~~Confidential~~
WORKING GUIDE FOR UTILIZATION OF
UNDERCOVER SPECIAL AGENTS

A. Predication

There are presently over 50 men and women fugitives who are believed involved in the underground apparatus, over 25 of whom are Weatherman affiliated, based on violations of Antiriot Law, Federal Bombing and Gun Control statutes, Sabotage and for various local violations where UFAP process has been issued. In addition to these fugitives being in an underground status, there are also a considerable number of missing Weatherman who are supporting fugitives from their underground status as well as over 200 individuals considered part of surface/support or legal Weatherman apparatus.

There are a number of collectives and communes wherein Weatherman support individuals reside. There are also other collectives and communes the true nature of which has not been fully determined, but whose members appear to be aligned with Weatherman and following basic Weatherman philosophy. These collectives, communes and related individuals must be investigated to determine if they are acting in support of Weatherman and are willing and capable of participation in violent terroristic revolutionary activity against the existing Government structure of the Nation. The above defined groups and individuals are suited for targeting by undercover Agents looking toward attaining the following objectives.

B. Objectives

1. Location and apprehension of Weatherman fugitives
2. Penetration of Weatherman underground and revolutionary collectives or communes which appear to relate to or support Weatherman underground apparatus
3. Neutralization of Weatherman underground apparatus which will lead to stoppage of their terrorist bombings and other violent revolutionary activity

C. Recommendations for Use of Agent
in These Assignments

1. Must have personal recommendation of SAC that Agent is physically and psychologically qualified for such an assignment
2. Must have specific target for penetration
3. Must have suitable cover identity
 - a. Assumed identity should include documentation such as birth certificate, social security card, draft card or discharge papers, driver's license, employment background and should not be that of a real living person. A forged criminal record in a police department may be utilized

Classified by 7725
Exempt from GDS, Category _____
Date of Declassification Indefinite
1/1/75 AD

12-1-73 721-65

- b. Cover identity, if necessary, would include rental of or ownership of suitable automobile, van or camper
 - c. Cover identity, if necessary, would include rental of suitable apartment or "pad" in appropriate neighborhood
- 4. Agent must be assigned code name which will be utilized when necessary in contacts with handling Agent
 - 5. Initial communication recommending Agent for particular assignment will be carried under newly assigned symbol number followed by letter S and word (Extremist) and submitted in coded teletype. This communication will not set forth Agent's true name, but his commission card number
 - 6. Review of recommendation will be made at FBIHQ by appropriate supervisor and recommendation by Revolutionary Activities Section submitted in a memorandum for approval

D. Security

1. At FBIHQ

- a. Assignment of symbol numbers which will be utilized in all communications. Commission card number will only be set out in body of initial coded teletype to FBIHQ under symbol number caption
- b. 134 informant file will be opened on each Agent approved
- c. A 134 control file will be maintained which contains this document and other general instructions which apply to undercover operations
- d. These 134 files will be maintained in locked bar cabinet in Revolutionary Activities Section
- e. Teletype Room will place Route in Envelope on all incoming teletypes which carry symbol number in caption
- f. Route In Envelope will be placed on all communications concerning Agent in this assignment even though symbol number caption is used
- g. Memorandum under Agent's name will be prepared for his personnel file noting he is on special assignment and any information concerning this assignment is maintained in 134-_____. Section Chief, Revolutionary Activities Section is to be called for such information
- h. A caution will be placed with movement unit and payroll records that any inquiries received concerning any Agent is an undercover assignment will be referred to Section Chief, Revolutionary Activities Section

2. In Field

Confidential

- a. A 134 file on undercover Agent is to be maintained in secure condition under control of appropriate supervisor
- b. A 134 control file will be maintained which contains this document and other general instructions which apply to undercover operations
- c. Information concerning Agent's assignment is to be made available on a need-to-know basis only
- d. Each undercover Agent is to have a handling Agent who will receive pertinent information from him telephonically or in person, if necessary. This information should be recorded in the 134 file in accordance with existing instructions for recording information from informants. FD-302 should be utilized where appropriate
- e. Handling Agent should personally contact the undercover Agent, preferably weekly, to assess his progress toward stated target and prepare memorandum for 134 file describing performance and progress of undercover Agent
- f. The weekly assessment of the contacting Agent should be reviewed by the SAC and utilized in preparation of a monthly teletype to the Bureau under appropriate symbol number caption. This teletype is to be submitted by the 15th of each month and is to include target of Agent, progress made to effect penetration of target and prognosis for future penetration. Pertinent data obtained from Agent is to be summarized and an assessment made by SAC of Agent's performance, progress and continued use is to be noted. A comment is also to be made by SAC of Agent's continued motivation and attitude and does he have any personal problems which may affect his assignment
- g. SAC, or in his extended absence ASAC, at frequent intervals not in any instance to exceed 60 days, should arrange to personally meet with the undercover Agent, away from the office and under secure conditions, to personally assess the mental and physical welfare and condition of the Agent. The field official should coordinate closely with contacting Agent and satisfy himself the undercover Agent's productivity, motivation, attitude and direction are consistent with the Bureau's interests and within the objectives of that office in recommending utilization of the Agent in this assignment. The SAC, or ASAC, should record this contact in the field 134 file
- h. The requirement for annual physical examinations should be adhered to by Agents on special assignments where possible. In the event a situation exists where making the Agent available for a physical examination would compromise his cover or jeopardize his security or welfare, advise

Confidential

under symbol number with recommendation as to when this examination can be conducted.

It is highly desirable that examination be performed at a government facility, however, if reasonable security not possible consideration can be given to utilizing facility of adjacent field office where such security is available. Secure physical examinations can be arranged through Administrative Division, FBIHQ at Washington, D.C., facilities and this alternative should be considered within practical limits of time and cost of travel involved. As a last resort, where SAC feels security considerations warrant it, a reliable office private medical contact may be considered. Any planned deviation from use of normal government facilities is to be furnished FBIHQ under symbol number caption with full supportive facts for approval

E. Inspection Matters

The Inspector is to personally handle this phase of inspections (or if absolutely essential the Number One Man). There should be no discussion among the Inspection Staff of these matters. After an inspection begins, the Inspector will receive from the office of the Assistant Director, Inspection Division, a write-up identifying the undercover operations in existence in the office. Early in the inspection the following should be done:

1. Review the undercover Agent's 134 file in the field
2. Review pertinent substantive files that show results of the undercover operation
3. Discuss with the SAC what administrative devices are in existence. This includes any written instructions to the undercover Agents, the method used by the office in contacting the Agent and the method used by the Agent in contacting the office. Also, review reports or other communications submitted by the undercover Agent which account for his activities and whereabouts
4. Review the security procedures in effect in the office to assure that all logical precautions are being taken. Determine the reasonableness of the cover being used by the Agent and steps taken to document his cover story. Check for conformity to the general guidelines contained in the other sections of this working guide
5. Interview the undercover Agent. The SAC should be requested to arrange for the time and place of the meeting so that it will be afforded maximum security and introduce the Inspector to the Agent. It is realized that there may be rare instances when it will not be feasible to interview an undercover Agent during an inspection. This could occur if the individual was involved in a highly active situation and security of the operation could be jeopardized if the undercover Agent broke away in order to meet the Inspector. Undercover Agents should not be called in from annual leave for a routine interview

Confidential

6. During the interview probe for potential trouble areas, as well as examine the overall value of the operation. Your interview should include but not necessarily be limited to the following points:
 - a. Is the Agent satisfied with his assignment?
 - b. Is he encountering any personal difficulties which could affect his future usefulness on this assignment? Does he have any family problems which have a bearing on his assignment?
 - c. Does he understand the objective of his assignment and is he making progress in accomplishing it? Does he have any suggestions to further improve the program or to increase his chance of success in accomplishing his mission?

7. At the conclusion of the interview, prepare a memorandum from you to the SAC for each undercover Agent in the office whether or not interviewed. This memo should be in duplicate and should be captioned with the undercover Agent's symbol number. Do not refer to him by name, use phrase "the source" or the "informant." Include in the memo the following:
 - a. The date of the interview and by whom. If the undercover Agent was not interviewed, so state and the reason
 - b. The nature of the undercover operation in general terms, i.e., why the operation is in effect in the field office and what it is supposed to accomplish
 - c. A brief description of how the undercover activity operates and the administrative controls that are in effect
 - d. Comments regarding the suitability of the individual undercover Agent, including any difficulties he is encountering in this assignment
 - e. Suggestions the Agent or Inspector might have for improving any aspect of the undercover operation
 - f. A specific recommendation by the Inspector concerning:
 - Whether the Agent should be continued in this assignment
 - g. Comments of SAC should be requested

8. In the event the Inspector feels it is necessary to prepare a memorandum concerning the general operation of Agents undercover in a division, a memorandum under a caption using appropriate symbol numbers of the personnel should be utilized with copies designated for the appropriate 134 files in the field office including the 134 control file.

Confidential

Confidential

After the SAC puts his addendum on the memo, the original memo with addendum should be left with the SAC for filing in the 134 file maintained in that Division after any necessary action is taken. Under no circumstances are any copies to be made of this memo except the one copy indicated above. The undercover operation and the undercover Agents are not to be commented on in any place in the inspection work papers, write-ups, or letter. Appropriate comments concerning an undercover operation may be included in the inspection summary prepared for The Director.

T The Inspector should discuss with Assistant Director, Inspection Division, any problems you encounter in this phase of the inspection.

F. Funds

1. Normally accrued expenses by undercover Agents will be claimed from Confidential Fund. Blue slip submitted for expense will show symbol number followed by designation (Extremist) and code name. Blue slip, consistent with security and where no receipt under Agent's assumed name is sent, will contain breakdown generally itemizing manner in which such expenses were incurred. At no time should names of targets be mentioned in itemization.
2. Receipts will be obtained under assumed name where practical. Bureau authority is to be requested for unusual or out of the ordinary expenses incurred in connection with these assignments
3. Per diem accrued while on this assignment and travel expenses incurred in connection with same may be claimed on regularly submitted monthly expense voucher. If receipt obtained under assumed identity, SAC, on note attached to voucher, will stipulate no receipts attached due to confidential nature of assignment, adding he reviewed receipts and found them to be accurate. If applicable, SAC should also stipulate nature of assignment precluded use of GTR
4. Symbol number and code name are available to Data Processing Section, Confidential Funds, for their use when blue slips are submitted
5. When an undercover Agent incurs regularly anticipated expenses in connection with a special assignment such as rent, utilities for an apartment and/or vehicle expenses, SAC is authorized to advance funds from the Confidential Fund to cover such expenses. Specifically, when these expenses are due for payment, the contacting Agent, prior to next prearranged contact, should withdraw necessary amount from Confidential Fund

Confidential

Confidential

and give same to undercover Agent. Receipts for payments will be given contacting Agent at time of next contact who will have them properly recorded in Confidential Fund records. See item F 1 on handling if no receipts obtained.

SAC is to insure that requested advance is justified and sufficient to coincide with particular needs of each undercover Agent. It must be realized these undercover operations do not enjoy unlimited financial backing. Expenditures concerning each operation must be logical and completely justified and will receive close supervision at FBIHQ consistent with overall needs of the Bureau.

6. When Agents are utilized on special assignments, it is frequently necessary to obtain a suitable vehicle to facilitate their movement among targeted groups and make their cover more attractive to those targeted.

To insure adequate cover for personnel involved, the vehicle should be registered in cover identity as would be done under normal circumstances. Insure adequate insurance is obtained under cover identity to protect cover and personnel involved. The cost should be handled the same as other routine expenses incurred in these operations.

From a liability viewpoint, vehicles operated in this manner are in fact Government vehicles and being operated on official business by a Government employee. Government liability would surface, for example, in the event liability on part of Agent in an at fault accident was in excess of that provided by insurance carried. FBIHQ must be advised of full details where any insurance claims are encountered involving a cover identity

G. Safeguards

1. Bureau property of Agents on these assignments is not to be maintained on their person or premises and such property should be maintained securely in office of SAC
 - a. Where circumstances warrant it in the personal judgement of the SAC, an appropriate firearm and credentials may be issued to the Agent on covert assignment while these circumstances exist
2. If arrested while on assignment by local authorities and Agent and others in his group are represented by an attorney, Agent should not report on the attorney-client relationship of others involved in such an arrest. To withdraw from the attorney-client relationship would draw immediate attention and suspicion to the Agent

Confidential

Confidential

3. Care should be given to arranging the Agent's personal finances (paycheck, bonds, etc.) and correspondence matters consistent with the Agent's cover and in a manner adequate to insure his safety.
4. A Stop Index File entry under Security Activities caption has been personally placed with the Assistant Director, Computer Systems Division, under symbol number and assumed name (cover identity) of Agent. If a local law enforcement agency makes an inquiry about the Agent under his assumed name, it will be advised we have no information concerning this individual; however, Section Chief, Revolutionary Activities Section, will be immediately advised and appropriate action taken

H. Administrative Matters

1. Monthly Administrative Report

SAC Letter 70-20 (A), dated 4/14/70, sets forth instructions and guidelines as to total number of Agents with General Investigative assignments and total number of Agents with No Matters Assigned as reported on Monthly Administrative Report. Under number two category Agents on special assignment are included. Accordingly, Agents in undercover operations are to be included in this category. The Inspector or Number One Man will handle these individuals on inspections. Manual of Rules and Regulations, Part II, Section 3, page 20a, requires details supporting entries in this category on file copy. Concerning Agents in this assignment supportive material will only be comment, "see 134 (file on Agent)"

2. Maintenance of records

- a. To preclude unnecessary exposure of records pertaining to these Agents, the Agents should be assigned to the SAC where practical
- b. The contacting Agent should satisfy himself the undercover Agent is productively engaged on a full time basis and is performing at least the minimally required (fringe) 109 minutes per day overtime daily (it being recognized in most instances this is virtually a 24 hour per day, seven days a week assignment). On the form FD-329 (overtime card) there should be posted in a normal working pattern sufficient overtime that the card for a given month will average out to 109 minutes per day or higher. In this regard, insure the average

Confidential

Confidential

achieved is compatible with other Agents on regular investigative matters so that overtime of undercover Agent is not highlighted and appears as an exception. These observations are to be included in the weekly memorandum (D, 2, d, supra) submitted by the contacting Agent.

- c. Necessary data for completion of the time and attendance records of the undercover Agent should be furnished the SAC's secretary for processing
- d. Upon review of pertinent 134 file, specifically weekly memoranda of contacting Agent, SAC will certify undercover Agent for fringe unless facts do not warrant it.
- e. In most instances, practical consideration of these assignments will preclude use of #1 Register and FD-256 (#3 locate card) by personnel in these assignments

I. General Comments

- 1. The security and well being of personnel involved in these special assignments are of paramount interest to all parties, FBIHQ, field personnel and the Inspection Staff
- 2. The above guidelines are intended for guidance and it is expected that good judgement in adhering to them will be utilized bearing in mind Item 1 above
- 3. Again bearing in mind Item 1 above, it is expected these operations will be handled on a strictly need-to-know basis and under tight security
- 4. In connection with undercover assignment, Agent is to be on lookout for individuals who may possess characteristics that would make them approachable for interview under Special Target Informant Development (SPECTAR) Program. If positive information is received in this regard it should be furnished to Agents specifically assigned this program who will handle interview where warranted.

Confidential

UNITED STATES GOVERNMENT

Memorandum

- Assoc. Dir. _____
- Asst. Dir.:
- Admin. _____
- Comp. Syst. _____
- Ext. Affairs _____
- Files & Com. _____
- Gen. Inv. _____
- Ident. _____
- Inspection _____
- Intell. _____
- Laboratory _____
- Plan. & Eval. _____
- Spec. Inv. _____
- Training _____
- Legal Coun. _____
- Telephone Rm. _____
- Director Sec'y _____

TO : Mr. E. S. Miller *EM*

DATE: 11/7/73

FROM : R. L. Shackelford *RLS*

CONFIDENTIAL

SUBJECT: REVOLUTIONARY ACTIVITIES
INFORMANT PROGRAM (EXTREMIST)
INTERNAL SECURITY

SYNOPSIS:

Instructions concerning handling of Special Agents acting in an undercover capacity for the purpose of locating and apprehending Weatherman fugitives and penetrating the Weatherman underground are set forth in a "Working Guide for Utilization of Undercover Special Agents" (Working Guide). The Working Guide, largely administrative in nature, should be updated to incorporate administrative instructions previously furnished interested offices by separate communications since overall Working Guide was last completely updated and furnished the field 11/24/72. A new section should be added to the Working Guide covering operational aspects of this program; namely, that targeting or retargeting of undercover Agents requires Headquarters authorization, that undercover Agents must operate independently of one another, and should not be utilized in routine surveillance operations or operationally involved with conventionally attired Special Agent personnel. Exceptions to the foregoing only with Headquarters authority. Attached for approval are revised and additional pages of the Working Guide with changes and additions underlined. Caption of program also being changed to above from more general caption previously used.

ACTION:

1 REC-85

134-23721-176
NOV 26 1973

If approved, copies of revised and additional pages will be furnished pertinent field offices by separate communication.

Enclosure

BPM:lm
(1)

Classified by 6922
Exempt from GDS, Category 2
Date of Declassification Indefinite

WP 6/5/75 : CONTINUED - OVER

5-WNP

~~ENCLOSURE~~

134-23721

CONFIDENTIAL
ROUTE IN ENVELOPE

58 DEC 7 1973

Memorandum to Mr. E. S. Miller
Re: Revolutionary Activities
Informant Program (Extremist)

CONFIDENTIAL

BACKGROUND:

To insure our sensitive operations involving undercover Agents are afforded maximum security at FBI Headquarters and the field, memorandum dated 9/6/72 captioned "Revolutionary Activities - Violence; Internal Security - Revolutionary Activities," approved by then Acting Director L. P. Gray III, authorized furnishing selected SACs, who may be involved in these operations, with "Working Guide for Utilization of Undercover Special Agents," hereafter referred to as Working Guide.

The Working Guide sets forth objectives of captioned program and enumerates guidelines (mostly administrative in nature) regarding the operation of this program which has been in effect for slightly over one year. During this period a number of additional instructions concerning administrative aspects of this program have been furnished interested offices by separate communications.

A careful review of the substantive aspects of this program for the past year has disclosed a need to bring to the attention of involved SACs certain operational instructions concerning utilization of undercover Agents. These instructions are believed necessary based upon our investigative experience since the inception of this program, to insure that certain practices, not in the best interests of the FBI, are avoided. Apropos of the foregoing the following instructions are set forth:

1. Headquarters authority is required for targeting or retargeting of undercover Agents.

SACs have been given considerable latitude in selecting targets for undercover Agents which targets must then be submitted to Headquarters for approval. Inasmuch as undercover Agent targeting goes to the heart of this program, close Headquarters supervision is essential to insure utilization of this technique is restricted to the purposes for which this program was established; namely, to locate and

CONFIDENTIAL

Memorandum to Mr. E. S. Miller
Re: Revolutionary Activities
Informant Program (Extremist)

apprehend Weatherman fugitives and to penetrate the Weatherman underground apparatus. It is essential, therefore, that Headquarters approval be obtained for target selection and no change in such target be made without prior Headquarters approval.

2. Undercover Agents are not to be utilized in routine surveillance operations.

It is a recognized fact that revolutionaries are extremely conscious of the surveillance technique and would go to considerable lengths to expose surveillance. To assure maximum protection for this program, it is essential that undercover sources, established after a considerable investment of time, money, and effort, not be utilized for routine physical surveillance operations which are properly the responsibility of regularly assigned personnel. Participating SACs must be made aware that despite the excellent cover these undercover Agents provide for physical surveillance operations, such utilization could lead to exposure of this technique or compromise of an individual undercover Agent and, therefore, is not authorized.

3. Undercover Agents must operate independently of one another.

It must be anticipated that in the event one of our undercover Agents is compromised, considerable effort will be expended by certain segments of the news media, revolutionary activists, New Left attorneys, and others of similar persuasion, to determine whether additional FBI undercover personnel are engaged in the same operation as the compromised undercover Agent and, if so, can the related FBI personnel be uncovered. It is

CONFIDENTIAL

Memorandum to Mr. E. S. Miller
Re: Revolutionary Activities
Informant Program (Extremist)

CC: [unclear]

essential, therefore, should one of our undercover Agents be compromised, that the damage be confined to that one situation and there be no way of linking the compromised undercover Agent with other undercover operations. To insure this situation does not occur, our undercover Agents must operate independently of one another.

4. Undercover Agents are not to be utilized in conjunction with conventionally attired Special Agent personnel.

Utilization of undercover Agents in conjunction with conventionally attired Special Agent personnel greatly increases the possibility the undercover Agent will be identified as a law enforcement operative and thereby be compromised. This, of course, does not preclude contact of an undercover Agent with his handling Agent made under completely secure conditions.

It is acknowledged concerning the above that a particularly exigent situation may dictate the utilization of an undercover Agent or Agents in contradiction to the above instructions. In such instances attempts must be made to obtain prior Headquarters approval, telephonically if necessary. Should circumstances preclude obtaining Headquarters authority, however, approval to utilize undercover Agents contrary to the above instructions must be obtained from the SAC (or in his absence, from his designated representative) and Headquarters advised immediately thereafter with complete justification set forth concerning the action taken.

As noted supra, additional administrative instructions have been furnished interested offices by separate communications since the last complete updating of the Working Guide. It is believed these instructions should now be incorporated into the appropriate section of the Working Guide. It is also deemed necessary at this time to add a new "Operational Guidelines"

CONFIDENTIAL

Memorandum to Mr. E. S. Miller.
Re: Revolutionary Activities
Informant Program (Extremist)

section to the Working Guide consisting of the investigative instructions enumerated above. Attached for approval are revised pages 2, 7, 8, and 9 and additional pages 10 and 11 of the Working Guide with changes and additions underlined.

In addition to the foregoing, in order to facilitate isolation of all material related to this overall program in one separate secure control file, and to eliminate the burden of insuring that communications concerning this matter are not inadvertently filed with routine mail utilizing the original, more general caption "Revolutionary Activities - Violence; Internal Security," communications relating to this overall program will henceforth contain the above-indicated caption and Headquarters file number 134-23721.

ACTION:

If approved, copies of revised and additional pages will be furnished pertinent field offices by separate communication.

BZM
WWD

OK
EM

WRW/TJS

CONFIDENTIAL

WORKING GUIDE FOR UTILIZATION OF
UNDERCOVER SPECIAL AGENTS

A. Predication

There are presently over 50 men and women fugitives who are believed involved in the underground apparatus, over 25 of whom are Weatherman affiliated, based on violations of Antiriot Law, Federal Bombing and Gun Control statutes, Sabotage and for various local violations where UFAP process has been issued. In addition to these fugitives being in an underground status, there are also a considerable number of missing Weatherman who are supporting fugitives from their underground status as well as over 200 individuals considered part of surface/support or legal Weatherman apparatus.

There are a number of collectives and communes wherein Weatherman support individuals reside. There are also other collectives and communes the true nature of which has not been fully determined, but whose members appear to be aligned with Weatherman and following basic Weatherman philosophy. These collectives, communes and related individuals must be investigated to determine if they are acting in support of Weatherman and are willing and capable of participation in violent terroristic revolutionary activity against the existing Government structure of the Nation. The above defined groups and individuals are suited for targeting by undercover Agents looking toward attaining the following objectives.

B. Objectives

1. Location and apprehension of Weatherman fugitives
2. Penetration of Weatherman underground and revolutionary collectives or communes which appear to relate to or support Weatherman underground apparatus
3. Neutralization of Weatherman underground apparatus which will lead to stoppage of their terrorist bombings and other violent revolutionary activity

C. Recommendations for Use of Agent
in These Assignments

1. Must have personal recommendation of SAC that Agent is physically and psychologically qualified for such an assignment
2. Must have specific target for penetration
3. Must have suitable cover identity
 - a. Assumed identity should include documentation such as birth certificate, social security card, draft card or discharge papers, driver's license, employment background and should not be that of a real living person. A faked criminal record in a police department may be utilized

- b. Cover identity, if necessary, would include rental of or ownership of suitable automobile, van or camper
 - c. Cover identity, if necessary, would include rental of suitable apartment or "pad" in appropriate neighborhood.
4. Agent must be assigned code name which will be utilized when necessary in contacts with handling Agent
 5. Initial communication recommending Agent for particular assignment will be carried under newly assigned symbol number followed by letter S and word (Extremist) and submitted in coded teletype. This communication will not set forth Agent's true name, but his commission card number
 6. Review of recommendation will be made at FBIHQ by appropriate supervisor and recommendation by IS-2 Section submitted in a memorandum for approval

D. Security

1. At FBIHQ

- a. Assignment of symbol numbers which will be utilized in all communications. Commission card number will only be set out in body of initial coded teletype to FBIHQ under symbol number caption
- b. 134 informant file will be opened on each Agent approved
- c. A 134 control file will be maintained which contains this document and other general instructions which apply to undercover operations
- d. These 134 files will be maintained in locked bar cabinet in IS-2 Section
- e. Teletype Room will place Route in Envelope on all incoming teletypes which carry symbol number in caption
- f. Route in Envelope will be placed on all communications concerning Agent in this assignment even though symbol number caption is used
- g. Memorandum under Agent's name will be prepared for his personnel file noting he is on special assignment and any information concerning this assignment is maintained in 134-____. Section Chief, IS-2 Section is to be called for such information
- h. A caution will be placed with movement unit and payroll records that any inquiries received concerning any Agent in an undercover assignment will be referred to Section Chief, IS-2 Section

2. In Field

- a. A 134 file on undercover Agent is to be maintained in secure condition under control of appropriate supervisor
- b. A 134 control file will be maintained which contains this document and other general instructions which apply to undercover operations
- c. Information concerning Agent's assignment is to be made available on a need-to-know basis only
- d. Each undercover Agent is to have a handling Agent who will receive pertinent information from him telephonically or in person, if necessary. This information should be recorded in the 134 file in accordance with existing instructions for recording information from informants. FD-302 should be utilized where appropriate
- e. Handling Agent should personally contact the undercover Agent, preferably weekly, to assess his progress toward stated target and prepare memorandum for 134 file describing performance and progress of undercover Agent
- f. The weekly assessment of the contacting Agent should be reviewed by the SAC and utilized in preparation of a monthly teletype to the Bureau under appropriate symbol number caption. This teletype is to be submitted by the 15th of each month and is to include target of Agent, progress made to effect penetration of target and prognosis for future penetration. Pertinent data obtained from Agent is to be summarized and an assessment made by SAC of Agent's performance, progress and continued use is to be noted. A comment is also to be made by SAC of Agent's continued motivation and attitude and does he have any personal problems which may affect his assignment
- g. SAC, or in his extended absence ASAC, at frequent intervals not in any instance to exceed 60 days, should arrange to personally meet with the undercover Agent, away from the office and under secure conditions, to personally assess the mental and physical welfare and condition of the Agent. The field official should coordinate closely with contacting Agent and satisfy himself the undercover Agent's productivity, motivation, attitude and direction are consistent with the Bureau's interests and within the objectives of that office in recommending utilization of the Agent in this assignment. The SAC, or ASAC, should record this contact in the field 134 file
- h. The requirement for annual physical examinations should be adhered to by Agents on special assignments where possible. In the event a situation exists where making the Agent available for a physical examination would compromise his cover or jeopardize his security or welfare, advise P.M.

under symbol number with recommendation as to when this examination can be conducted.

It is highly desirable that examination be performed at a government facility, however, if reasonable security not possible consideration can be given to utilizing facility of adjacent field office where such security is available. Secure physical examinations can be arranged through Administrative Division, FBIHQ at Washington, D.C., facilities and this alternative should be considered within practical limits of time and cost of travel involved. As a last resort, where SAC feels security considerations warrant it, a reliable office private medical contact may be considered. Any planned deviation from use of normal government facilities is to be furnished FBIHQ under symbol number caption with full supportive facts for approval.

E. Inspection Matters

The Inspector is to personally handle this phase of inspections (or if absolutely essential the Number One Man). There should be no discussion among the Inspection Staff of these matters. After an inspection begins, the Inspector will receive from the office of the Assistant Director, Inspection Division, a write-up identifying the undercover operations in existence in the office. Early in the inspection the following should be done:

1. Review the undercover Agent's 134 file in the field
2. Review pertinent substantive files that show results of the undercover operation
3. Discuss with the SAC what administrative devices are in existence. This includes any written instructions to the undercover Agents, the method used by the office in contacting the Agent and the method used by the Agent in contacting the office. Also, review reports or other communications submitted by the undercover Agent which account for his activities and whereabouts
4. Review the security procedures in effect in the office to assure that all logical precautions are being taken. Determine the reasonableness of the cover being used by the Agent and steps taken to document his cover story. Check for conformity to the general guidelines contained in the other sections of this working guide
5. Interview the undercover Agent. The SAC should be requested to arrange for the time and place of the meeting so that it will be afforded maximum security and introduce the Inspector to the Agent. It is realized that there may be rare instances when it will not be feasible to interview an undercover Agent during an inspection. This could occur if the individual was involved in a highly active situation and security of the operation could be jeopardized if the undercover Agent broke away in order to meet the Inspector. Undercover Agents should not be called in from annual leave for a routine interview

6. During the interview probe for potential trouble areas, as well as examine the overall value of the operation. Your interview should include but not necessarily be limited to the following points:
- a. Is the Agent satisfied with his assignment?
 - b. Is he encountering any personal difficulties which could affect his future usefulness on this assignment? Does he have any family problems which have a bearing on his assignment?
 - c. Does he understand the objective of his assignment and is he making progress in accomplishing it? Does he have any suggestions to further improve the program or to increase his chance of success in accomplishing his mission?
7. At the conclusion of the interview, prepare a memorandum from you to the SAC for each undercover Agent in the office whether or not interviewed. This memo should be in duplicate and should be captioned with the undercover Agent's symbol number. Do not refer to him by name, use phrase "the source" or the "informant." Include in the memo the following:
- a. The date of the interview and by whom. If the undercover Agent was not interviewed, so state and the reason
 - b. The nature of the undercover operation in general terms, i.e., why the operation is in effect in the field office and what it is supposed to accomplish
 - c. A brief description of how the undercover activity operates and the administrative controls that are in effect
 - d. Comments regarding the suitability of the individual undercover Agent, including any difficulties he is encountering in this assignment
 - e. Suggestions the Agent or Inspector might have for improving any aspect of the undercover operation
 - f. A specific recommendation by the Inspector concerning:
 - Whether the Agent should be continued in this assignment
 - g. Comments of SAC should be requested
8. In the event the Inspector feels it is necessary to prepare a memorandum concerning the general operation of Agents undercover in a division, a memorandum under a caption using appropriate symbol numbers of the personnel should be utilized with copies designated for the appropriate 134 files in the field office including the 134 control file.

After the SAC puts his addendum on the memo, the original memo with addendum should be left with the SAC for filing in the 134 file maintained in that Division after any necessary action is taken. Under no circumstances are any copies to be made of this memo except the one copy indicated above. The undercover operation and the undercover Agents are not to be commented on in any place in the inspection work papers, write-ups, or letter. Appropriate comments concerning an undercover operation may be included in the inspection summary prepared for The Director.

F The Inspector should discuss with Assistant Director, Inspection Division, any problems you encounter in this phase of the inspection.

F. Funds

1. Normally accrued expenses by undercover Agents will be claimed from Confidential Fund. Blue slip submitted for expense will show symbol number followed by designation (Extremist) and code name. Blue slip, consistent with security and where no receipt under Agent's assumed name is sent, will contain breakdown generally itemizing manner in which such expenses were incurred. At no time should names of targets be mentioned in itemization.
2. Receipts will be obtained under assumed name where practical. Bureau authority is to be requested for unusual or out of the ordinary expenses incurred in connection with these assignments
3. Per diem accrued while on this assignment and travel expenses incurred in connection with same may be claimed on regularly submitted monthly expense voucher. If receipt obtained under assumed identity, SAC, on note attached to voucher, will stipulate no receipts attached due to confidential nature of assignment, adding he reviewed receipts and found them to be accurate. If applicable, SAC should also stipulate nature of assignment precluded use of GTR
4. Symbol number and code name are available to Data Processing Section, Confidential Funds, for their use when blue slips are submitted
5. When an undercover Agent incurs regularly anticipated expenses in connection with a special assignment such as rent, utilities for an apartment and/or vehicle expenses, SAC is authorized to advance funds from the Confidential Fund to cover such expenses. Specifically, when these expenses are due for payment, the contacting Agent, prior to next report contact, should withdraw necessary amount from Confidential

CONFIDENTIAL

and give same to undercover Agent. Receipts for payments will be given contacting Agent at time of next contact who will have them properly recorded in Confidential Fund records. See item F 1 on handling if no receipts obtained.

SAC is to insure that requested advance is justified and sufficient to coincide with particular needs of each undercover Agent. It must be realized these undercover operations do not enjoy unlimited financial backing. Expenditures concerning each operation must be logical and completely justified and will receive close supervision at FBIHQ consistent with overall needs of the Bureau. Headquarters teletype 12/19/72 should be cited on FD-37 as authority for expenditures in these matters. Instructions set forth in Headquarters airtel to all offices 8/14/72 captioned "Authority to Approve Limited Expenditures for Investigative Operations" do not apply in these matters.

6. When Agents are utilized on special assignments, it is frequently necessary to obtain a suitable vehicle to facilitate their movement among targeted groups and make their cover more attractive to those targeted.

To insure adequate cover for personnel involved, the vehicle should be registered in cover identity as would be done under normal circumstances. Insure adequate insurance is obtained under cover identity to protect cover and personnel involved. The cost should be handled the same as other routine expenses incurred in these operations.

From a liability viewpoint, vehicles operated in this manner are in fact Government vehicles and being operated on official business by a Government employee. Government liability would surface, for example, in the event liability on part of Agent in an at fault accident was in excess of that provided by insurance carried. FBIHQ must be advised of full details where any insurance claims are encountered involving a cover identity.

When an Agent leaves undercover assignment it sometimes will be necessary for an office to sell the vehicle used by him in this assignment for security reasons. Since this vehicle is not part of the office complement and was purchased through the Confidential Fund any proceeds from the sale of the vehicle should be applied back to the Confidential Fund. A check for the proceeds from the sale should be submitted to Headquarters and made payable to Treasurer of the United States. This check should be a cashiers check and not a check from the office Confidential Fund.

CONFIDENTIAL

CONFIDENTIAL

7. In connection with these assignments from time to time it may be necessary for undercover Agents, under their assumed names, to gain employment. To insure Federal and local tax laws are adhered to, certain procedures are to be taken in these matters. Withholding tax is to be taken out of wages consistent with Federal and local regulations. A Federal and State tax return, when due, is to be filed under the Agent's assumed identity. Wages earned by an Agent in these assignments should be placed in cash (no checks or cover identity reference) in his own personal checking account and he should prepare a check in this amount under his true identity payable to the Treasurer of the United States. A cover communication is to be submitted with check under true name caption of Agent. This communication will state that in connection with his official duties captioned Agent received \$ on date. Attached is a check for this amount from captioned Agent to Treasurer of the United States. The same procedure would be used upon refund of any taxes paid under cover identity. Copies of all tax forms submitted in these operations are to be maintained in the appropriate field 134 file on the source involved along with material pertaining to any refunds.

G. Safeguards

1. Bureau property of Agents on these assignments is not to be maintained on their person or premises and such property should be maintained securely in office of SAC
 - a. Where circumstances warrant it in the personal judgement of the SAC, an appropriate firearm and credentials may be issued to the Agent on covert assignment while these circumstances exist.
2. If arrested while on assignment by local authorities and Agent and others in his group are represented by an Attorney, Agent should not report on the attorney-client relationship of others involved in such an arrest. To withdraw from the attorney-client relationship would draw immediate attention and suspicion to the Agent
3. Care should be given to arranging the Agent's personal finances (paycheck, bonds, etc.) and correspondence matters consistent with the Agent's cover and in a manner adequate to insure his safety

CONFIDENTIAL

4. A Stop Index File entry under Security Activities caption has been personally placed with the Assistant Director, Computer Systems Division, under symbol number and assumed name (cover identity) of Agent. If a local law enforcement agency makes an inquiry about the Agent under his assumed name, it will be advised we have no information concerning this individual; however, Section Chief, IS-2 Section, will be immediately advised and appropriate action taken.

H. Operational Guidelines

In order to insure certain operational practices, not in the best interest of the program are avoided, the following instructions are set forth concerning utilization of undercover Agents.

1. Prior Headquarters authority is required for targeting or retargeting of undercover Agents.
2. Undercover Agents are not to be utilized in routine surveillance operations.
3. Undercover Agents must operate independently of one another
4. Undercover Agents are not to be utilized in conjunction with conventionally attired Special Agent personnel

In the event a particularly exigent situation appears to warrant the utilization of an undercover Agent or Agents in contradiction to the above instructions, attempts must be made, telephonically if necessary, to obtain prior Headquarters authorization for such action. Should circumstances preclude obtaining Headquarters authorization, however, approval for such utilization of undercover Agents must be obtained from the SAC or his designated representative and Headquarters advised immediately thereafter with complete justification set forth concerning the action taken.

I. Administrative Matters

1. Monthly Administrative Report

SAC letter 70-20 (A), dated 4/14/70, sets forth instructions and guidelines as to total number of Agents with General Investigative assignments and total number of Agents with No Matters Assigned as reported on Monthly Administrative Report. Under number two category Agents on special assignment are included. Accordingly, Agents in undercover operations

CONFIDENTIAL

are to be included in this category. The Inspector or Number One Man will handle these individuals on inspections. Manual of Rules and Regulations, Part II, Section 3, page 20a, requires details supporting entries in this category on file copy. Concerning Agents in this assignment supportive material will only be comment, "see 134 (file on Agent)"

2. Maintenance of Records

- a. To preclude unnecessary exposure of records pertaining to these Agents, the Agents should be assigned to the SAC where practical
- b. The contacting Agent should satisfy himself the undercover Agent is productively engaged on a full time basis and is performing at least the minimally required (fringe) 109 minutes per day overtime daily (it being recognized in most instances this is virtually a 24 hour per day, seven days a week assignment). On the form FD-329 (overtime card) there should be posted in a normal working pattern sufficient overtime that the card for a given month will average out to 109 minutes per day or higher. In this regard, insure the average achieved is compatible with other Agents on regular investigative matters so that overtime of undercover Agent is not highlighted and appears as an exception. These observations are to be included in the weekly memorandum (D, 2, d, supra) submitted by the contacting Agent.
- c. Necessary data for completion of the time and attendance records of the undercover Agent should be furnished the SAC's secretary for processing
- d. Upon review of pertinent 134 file, specifically weekly memoranda of contacting Agent, SAC will certify undercover Agent for fringe unless facts do not warrant it
- e. In most instances, practical consideration of these assignments will preclude use of #1 Register and FD-256 (#3 locate card) by personnel in these assignments
- f. Agents engaged in undercover operations should be considered, where applicable, for assignment to a 4:00 p.m. to 12:00 midnight shift on a regular basis, thus qualifying them for night differential pay.

CONFIDENTIAL

J. General Comments

1. The security and well being of personnel involved in these special assignments are of paramount interest to all parties, FBIHQ, field personnel and the Inspection Staff
2. The above guidelines are intended for guidance and it is expected that good judgement in adhering to them will be utilized bearing in mind Item 1 above.
3. Again bearing in mind Item 1 above, it is expected these operations will be handled on a strictly need-to-know basis and under tight security.
4. In connection with undercover assignment, Agent is to be on lookout for individuals who may possess characteristics that would make them approachable for interview under Special Target Informant Development (SPECTAR) Program. If positive information is received in this regard it should be furnished to Agents specifically assigned this program who will handle interview where warranted.

Confidential

Airtel

To: SACs, Albany (Enc. 6) Philadelphia (Enc. 6)
 Boston (Enc. 6) Phoenix (Enc. 6) 11/13/73
 Chicago (Enc. 6) PERSONAL ATTENTION
 Cleveland (Enc. 6) Portland (Enc. 6)
 Denver (Enc. 6) St. Louis (Enc. 6)
 Detroit (Enc. 6) San Diego (Enc. 6)
 Los Angeles (Enc. 6) San Francisco (Enc. 6)
 Milwaukee (Enc. 6) Seattle (Enc. 6)
 New York (Enc. 6) Springfield (Enc. 6)
 Washington Field (Enc. 6)

1/27/75
 R/S to recipients - BU
 to classify airtel + encl.
 TAM

9-

From: Director, FBI (134-23721)

REVOLUTIONARY ACTIVITIES
 INFORMANT PROGRAM (EXTREMIST)
 INTERNAL SECURITY

Revolutionary Activities
Violence

ReHQairtel 11/24/72 captioned "Revolutionary Activities - Violence; IS - Revolutionary Activities," enclosing a revised copy of the "Working Guide for Utilization of Undercover Special Agents" (Working Guide). Enclosed are revised pages 2, 7, 8, and 9 and additional pages 10 and 11 of the Working Guide with changes and additions underlined. Previously received copies of revised pages should be replaced and destroyed.

Above-noted pages of the Working Guide are mainly concerned with administrative aspects of undercover Agent operations, which instructions have previously been furnished to you via separate communications.

As recipients are aware, this program has been in operation slightly more than one year. During this period, undercover Agents have displayed a unique talent for recognizing a target, exhibited considerable ingenuity in penetrating selected targets and demonstrated considerable competence in obtaining and reporting pertinent information. In addition to furnishing information concerning Weatherman support and other revolutionary activities, some undercover Agents have uncovered considerable ancillary information of investigative...

BPM:lm
 (37)

(Enclosures - 6)

134-23721-115
 REC-36
 SEE NOTE PAGE THREE

MAILED 20
 NOV 13 1973
 FBI

EX-110

3 NOV 13 1973

Confidential

ENCLOSURE

BOOTE IN ENVELOPE

Classified By 7225
 Exempt from GDS, Category 2

- Assoc. Dir. _____
- Asst. Dir.:
- Admin. _____
- Comp. Syst. _____
- Ext. Affairs _____
- Files & Com. _____
- Gen. Inv. _____
- Ident. _____
- Inspection _____
- Intell. _____
- Laboratory _____
- Plan. & Eval. _____
- Spec. Inv. _____
- Training _____
- Legal Coun. _____
- Telephone Rm. _____
- Director's Sec'y _____

Confidential

Airtel to Albany, et al
Re: Revolutionary Activities
Informant Program (Extremist)

and intelligence interest to this Bureau dealing with deserters, Selective Service violators, and sundry other matters which information would not have been available through any other means.

While Headquarters is pleased with the results obtained from this program, experience thus far has demonstrated a need to establish the following operational guidelines which must be strictly adhered to in utilization of undercover Agents:

1. Targets for undercover Agents should receive prior Headquarters clearance. No changes in target assignments or undercover Agent involvement in premeditated precipitative-type action should occur without first obtaining Headquarters authority.
2. Undercover Agents involved in this program should not be utilized for routine surveillance purposes. Revolutionaries are extremely conscious of the surveillance technique and will go to great lengths to expose a surveillance. The investment represented in these undercover Agents precludes their utilization in routine surveillances which should be handled by regularly assigned personnel.
3. Undercover Agents involved in this program should operate independently of one another. Such procedure is essential to insure that the activities of a compromised Agent cannot be traced to and cause the compromise of another undercover operation.
4. Undercover Agents involved in this program should not be utilized on assignments in conjunction with conventionally attired Agent personnel. This, of course, does not pertain to contacts with the handling Agent made under secure conditions.

Confidential

Airtel to Albany, et al
Re: Revolutionary Activities
Informant Program (Extremist)

It is recognized that situations may develop wherein circumstances will dictate the utilization of undercover Agents in contradiction to the above restrictions. In such instances, attempts must be made to first obtain prior Headquarters authority, telephonically, if necessary. Should circumstances preclude obtaining Headquarters authority, approval to use undercover Agents contrary to above instructions, must be obtained from the SAC or his designated representative and Headquarters immediately advised with full justification for the action taken.

The above guidelines are set forth in Section H of the Working Guide under the caption "Operational Instructions."

In addition to the above, Working Guide changes, to insure isolation of all material related to this overall program in one separate secure control file and to eliminate the burden of insuring that communications concerning this program are not inadvertently filed with routine mail utilizing the original, more general caption "Revolutionary Activities - Violence; Internal Security," future communications relating to this overall program should contain the above-indicated caption and Headquarters file number. Communications concerning specific undercover Agents should continue to be submitted under the individual informant's caption and corresponding Headquarters file number.

Above instructions should be carefully reviewed by you and appropriate supervisor to insure your investigative responsibilities and administrative procedures in these matters are handled securely and uniformly.

NOTE:

Memorandum R. L. Shackelford to Mr. E. S. Miller dated 11/7/73, EPM:lm, approved above change to Working Guide and authorized forwarding same to field.

Confidential

Confidential

- b. Cover identity, if necessary, would include rental of or ownership or suitable automobile, van or camper
 - c. Cover identity, if necessary, would include rental of suitable apartment or "pad" in appropriate neighborhood.
4. Agent must be assigned code name which will be utilized when necessary in contacts with handling Agent
 5. Initial communication recommending Agent for particular assignment will be carried under newly assigned symbol number followed by letter S and word (Extremist) and submitted in coded teletype. This communication will not set forth Agent's true name, but his commission card number
 6. Review of recommendation will be made at FBIHQ by appropriate supervisor and recommendation by IS-2 Section submitted in a memorandum for approval

D. Security

1. At FBIHQ
 - a. Assignment of symbol numbers which will be utilized in all communications. Commission card number will only be set out in body of initial coded teletype to FBIHQ under symbol number caption
 - b. 134 informant file will be opened on each Agent approved
 - c. A 134 control file will be maintained which contains this document and other general instructions which apply to undercover operations
 - d. These 134 files will be maintained in locked bar cabinet in IS-2 Section
 - e. Teletype Room will place Route in Envelope on all incoming teletypes which carry symbol number in caption
 - f. Route in Envelope will be placed on all communications concerning Agent in this assignment even though symbol number caption is used
 - g. Memorandum under Agent's name will be prepared for his personnel file noting he is on special assignment and any information concerning this assignment is maintained in 134-____. Section Chief, IS-2 Section is to be called for such information
 - h. A caution will be placed with movement unit and payroll records that any inquiries received concerning any Agent in an undercover assignment will be referred to Section Chief, IS-2 Section

Classified by 7225
Exempt from GDS, Category 2
Date of Declassification Indefinite

- 2 -

Confidential

134-23721-115
1/27/75 T/M

Confidential

and give same to undercover Agent. Receipts for payments will be given contacting Agent at time of next contact who will have them properly recorded in Confidential Fund records. See item F 1 on handling if no receipts obtained.

SAC is to insure that requested advance is justified and sufficient to coincide with particular needs of each undercover Agent. It must be realized these undercover operations do not enjoy unlimited financial backing. Expenditures concerning each operation must be logical and completely justified and will receive close supervision at FBIHQ consistent with overall needs of the Bureau. Headquarters teletype 12/19/72 should be cited on FD-37 as authority for expenditures in these matters. Instructions set forth in Headquarters airtel to all offices 8/14/72 captioned "Authority to Approve Limited Expenditures for Investigative Operations" do not apply in these matters.

6. When Agents are utilized on special assignments, it is frequently necessary to obtain a suitable vehicle to facilitate their movement among targeted groups and make their cover more attractive to those targeted.

To insure adequate cover for personnel involved, the vehicle should be registered in cover identity as would be done under normal circumstances. Insure adequate insurance is obtained under cover identity to protect cover and personnel involved. The cost should be handled the same as other routine expenses incurred in these operations.

From a liability viewpoint, vehicles operated in this manner are in fact Government vehicles and being operated on official business by a Government employee. Government liability would surface, for example, in the event liability on part of Agent in an at fault accident was in excess of that provided by insurance carried. FBIHQ must be advised of full details where any insurance claims are encountered involving a cover identity.

When an Agent leaves undercover assignment it sometimes will be necessary for an office to sell the vehicle used by him in this assignment for security reasons. Since this vehicle is not part of the office complement and was purchased through the Confidential Fund any proceeds from the sale of the vehicle should be applied back to the Confidential Fund. A check for the proceeds from the sale should be submitted to Headquarters and made payable to Treasurer of the United States. This check should be a cashiers check and not a check from the office Confidential Fund.

- 7 -

Confidential

134-23721-115

7. In connection with these assignments from time to time it may be necessary for undercover Agents, under their assumed names, to gain employment. To insure Federal and local tax laws are adhered to, certain procedures are to be taken in these matters. Withholding tax is to be taken out of wages consistent with Federal and local regulations. A Federal and State tax return, when due, is to be filed under the Agent's assumed identity. Wages earned by an Agent in these assignments should be placed in cash (no checks or cover identity reference) in his own personal checking account and he should prepare a check in this amount under his true identity payable to the Treasurer of the United States. A cover communication is to be submitted with check under true name caption of Agent. This communication will state that in connection with his official duties captioned Agent received \$ on date. Attached is a check for this amount from captioned Agent to Treasurer of the United States. The same procedure would be used upon refund of any taxes paid under cover identity. Copies of all tax forms submitted in these operations are to be maintained in the appropriate field 134 file on the source involved along with material pertaining to any refunds.

G. Safeguards

1. Bureau property of Agents on these assignments is not to be maintained on their person or premises and such property should be maintained securely in office of SAC
 - a. Where circumstances warrant it in the personal judgement of the SAC, an appropriate firearm and credentials may be issued to the Agent on covert assignment while these circumstances exist.
2. If arrested while on assignment by local authorities and Agent and others in his group are represented by an Attorney, Agent should not report on the attorney-client relationship of others involved in such an arrest. To withdraw from the attorney-client relationship would draw immediate attention and suspicion to the Agent
3. Care should be given to arranging the Agent's personal finances (paycheck, bonds, etc.) and correspondence matters consistent with the Agent's cover and in a manner adequate to insure his safety.

4. A Stop Index File entry under Security Activities caption has been personally placed with the Assistant Director, Computer Systems Division, under symbol number and assumed name (cover identity) of Agent. If a local law enforcement agency makes an inquiry about the Agent under his assumed name, it will be advised we have no information concerning this individual; however, Section Chief, IS-2 Section, will be immediately advised and appropriate action taken.

H. Operational Guidelines

In order to insure certain operational practices, not in the best interest of the program are avoided, the following instructions are set forth concerning utilization of undercover Agents.

1. Prior Headquarters authority is required for targeting or retargeting of undercover Agents.
2. Undercover Agents are not to be utilized in routine surveillance operations.
3. Undercover Agents must operate independently of one another
4. Undercover Agents are not to be utilized in conjunction with conventionally attired Special Agent personnel

In the event a particularly exigent situation appears to warrant the utilization of an undercover Agent or Agents in contradiction to the above instructions, attempts must be made, telephonically if necessary, to obtain prior Headquarters authorization for such action. Should circumstances preclude obtaining Headquarters authorization, however, approval for such utilization of undercover Agents must be obtained from the SAC or his designated representative and Headquarters advised immediately thereafter with complete justification set forth concerning the action taken.

I. Administrative Matters

1. Monthly Administrative Report

SAC letter 70-20 (A), dated 4/14/70, sets forth instructions and guidelines as to total number of Agents with General Investigative assignments and total number of Agents with No Matters Assigned as reported on Monthly Administrative Report. Under number two category Agents on special assignment are included. Accordingly, Agents in undercover operations

Confidential

are to be included in this category. The Inspector or Number One Man will handle these individuals on inspections. Manual of Rules and Regulations, Part II, Section 3, page 20a, requires details supporting entries in this category on file copy. Concerning Agents in this assignment supportive material will only be comment, "see 134 (file on Agent)"

2. Maintenance of Records

- a. To preclude unnecessary exposure of records pertaining to these Agents, the Agents should be assigned to the SAC where practical
- b. The contacting Agent should satisfy himself the undercover Agent is productively engaged on a full time basis and is performing at least the minimally required (fringe) 109 minutes per day overtime daily (it being recognized in most instances this is virtually a 24 hour per day, seven days a week assignment). On the form FD-329 (overtime card) there should be posted in a normal working pattern sufficient overtime that the card for a given month will average out to 109 minutes per day or higher. In this regard, insure the average achieved is compatible with other Agents on regular investigative matters so that overtime of undercover Agent is not highlighted and appears as an exception. These observations are to be included in the weekly memorandum (D, 2, d, supra) submitted by the contacting Agent.
- c. Necessary data for completion of the time and attendance records of the undercover Agent should be furnished the SAC's secretary for processing
- d. Upon review of pertinent 134 file, specifically weekly memoranda of contacting Agent, SAC will certify undercover Agent for fringe unless facts do not warrant it
- e. In most instances, practical consideration of these assignments will preclude use of #1 Register and FD-256 (#3 locate card) by personnel in these assignments
- f. Agents engaged in undercover operations should be considered, where applicable, for assignment to a 4:00 p.m. to 12:00 midnight shift on a regular basis, thus qualifying them for night differential pay.

Confidential

~~Confidential~~

J. General Comments

1. The security and well being of personnel involved in these special assignments are of paramount interest to all parties, FBIHQ, field personnel and the Inspection Staff.
2. The above guidelines are intended for guidance and it is expected that good judgement in adhering to them will be utilized bearing in mind Item 1 above.
3. Again bearing in mind Item 1 above, it is expected these operations will be handled on a strictly need-to-know basis and under tight security.
4. In connection with undercover assignment, Agent is to be on lookout for individuals who may possess characteristics that would make them approachable for interview under Special Target Informant Development (SPECTAR) Program. If positive information is received in this regard it should be furnished to Agents specifically assigned this program who will handle interview where warranted.

~~Confidential~~

- 11 -

ENCLOSURE

134-23721-115

Airtel

1 - Mr. T. J. McNiff
1 - Mr. W. N. Preusse

CONFIDENTIAL

10/11/74

To: SACs, Albany (Encs. - 2)
Boston (Encs. - 2)
Chicago (Encs. - 2)
Cleveland (Encs. - 2)
Denver (Encs. - 2)
Detroit (Encs. - 2)
Los Angeles (Enc. - 2)
Milwaukee (Encs. - 2)
New York (Encs. - 2)
Philadelphia (Encs. - 2)
Phoenix (Encs. - 2)

PERSONAL ATTENTION

Portland (Encs. - 2)
St. Louis (Encs. - 2)
San Diego (Encs. - 2)
San Francisco (Encs. - 2)
Seattle (Encs. - 2)
Springfield (Encs. - 2)
Washington Field (Encs.-2)

From: Director, FBI (134-23721)

REVOLUTIONARY ACTIVITIES
INFORMANT PROGRAM (EXTREMIST)
INTERNAL SECURITY

ReBuairtels dated 11/24/72 and 11/13/73 enclosing revised copy of the "Working Guide For Utilization of Undercover Special Agents" and revised pages for this Working Guide.

Your attention is called to SAC Memorandum 48-74 dated 10/8/74, Item (C), captioned "Indebtedness to the Government - Preferred Inscription on Checks." This item states that all checks issued in payments of amounts due the Federal Government are to be drawn payable to the specific organization whose account is to be credited with the payment rather than to the Treasurer of the United States. Accordingly, all remittances sent to FBI Headquarters to cover amounts due the Government should now be drawn payable to the Federal Bureau of Investigation.

Therefore, changes have been made on pages seven and eight of the Working Guide to conform with instructions noted in SAC Memorandum 48-74.

WNP:Im
(39)

CONFIDENTIAL
Classified by 6982
Exempt from GDS, Category 2
Date of Declassification Indefinite

OCT 18 1974

Recipients of this communication have previously been furnished Working Guide for Utilization of Undercover Special Agents and copies of instructions noted previously. This has been retransmitted to the Systems Division.

ENCLOSURE IN ENVELOPE

MAILED 8
OCT 11 1974
FBI

- Assoc. Dir. _____
- Dep. AD Adm. _____
- Dep. AD Inv. _____
- Asst. Dir.:
- Admin. _____
- Comp. Syst. _____
- Ext. Affairs _____
- Files & Com. _____
- Gen. Inv. _____
- Ident. _____
- Inspection _____
- Intell. _____
- Laboratory _____
- Legal Coun. _____
- Plan. & Eval. _____
- Spec. Inv. _____
- Training _____

Confidential

and give same to undercover Agent. Receipts for payments will be given contacting Agent at time of next contact who will have them properly recorded in Confidential Fund records. See item F 1 on handling if no receipts obtained.

SAC is to insure that requested advance is justified and sufficient to coincide with particular needs of each undercover Agent. It must be realized these undercover operations do not enjoy unlimited financial backing. Expenditures concerning each operation must be logical and completely justified and will receive close supervision at FBIHQ consistent with overall needs of the Bureau. Headquarters teletype 12/19/72 should be cited on FD-37 as authority for expenditures in these matters. Instructions set forth in Headquarters airtel to all offices 8/14/72 captioned "Authority to Approve Limited Expenditures for Investigative Operations" do not apply in these matters.

6. When Agents are utilized on special assignments, it is frequently necessary to obtain a suitable vehicle to facilitate their movement among targeted groups and make their cover more attractive to those targeted.

To insure adequate cover for personnel involved, the vehicle should be registered in cover identity as would be done under normal circumstances. Insure adequate insurance is obtained under cover identity to protect cover and personnel involved. The cost should be handled the same as other routine expenses incurred in these operations.

From a liability viewpoint, vehicles operated in this manner are in fact Government vehicles and being operated on official business by a Government employee. Government liability would surface, for example, in the event liability on part of Agent in an at fault accident was in excess of that provided by insurance carried. FBIHQ must be advised of full details where any insurance claims are encountered involving a cover identity.

When an Agent leaves undercover assignment it sometimes will be necessary for an office to sell the vehicle used by him in this assignment for security reasons. Since this vehicle is not part of the office complement and was purchased through the Confidential Fund any proceeds from the sale of the vehicle should be applied back to the Confidential Fund. A check for the proceeds from the sale should be submitted to Headquarters and made payable to the Federal Bureau of Investigation. This check should be a cashiers check and not a check from the office Confidential Fund.

Confidential

- 7 -

Classified by 7225
Exempt from GDS, Category 2
Date of Declassification Indefinite

1/27/75

7. In connection with these assignments from time to time it may be necessary for undercover Agents, under their assumed names, to gain employment. To insure Federal and local tax laws are adhered to, certain procedures are to be taken in these matters. Withholding tax is to be taken out of wages consistent with Federal and local regulations. A Federal and State tax return, when due, is to be filed under the Agent's assumed identity. Wages earned by an Agent in these assignments should be placed in cash (no checks or cover identity reference) in his own personal checking account and he should prepare a check in this amount under his true identity payable to the Federal Bureau of Investigation. A cover communication is to be submitted with check under true name caption of Agent. This communication will state that in connection with his official duties captioned Agent received \$ on date. Attached is a check for this amount from captioned Agent to Federal Bureau of Investigation. The same procedure would be used upon refund of any taxes paid under cover identity. Copies of all tax forms submitted in these operations are to be maintained in the appropriate field 134 file on the source involved along with material pertaining to any refunds.

G. Safeguards

1. Bureau property of Agents on these assignments is not to be maintained on their person or premises and such property should be maintained securely in office of SAC.
 - a. Where circumstances warrant it in the personal judgement of the SAC, an appropriate firearm and credentials may be issued to the Agent on covert assignment while these circumstances exist.
2. If arrested while on assignment by local authorities and Agent and others in his group are represented by an Attorney, Agent should not report on the attorney-client relationship of others involved in such an arrest. To withdraw from the attorney-client relationship would draw immediate attention and suspicion to the Agent.
3. Care should be given to arranging the Agent's personal finances (paycheck, bonds, etc.) and correspondence matters consistent with the Agent's cover and in a manner adequate to insure his safety.

AS/75 request

III - H
THE STANDARD SUB LIST

RETAIN

274-10/28



STANDARD SUB LIST

ACCIDENTS - FIELD (For Foreign Offices use Administrative File).....	66-2058
ACCOMPLISHMENTS - Foreign Offices only - (use sub for country where Legat is located).....	64-44362
ACCOMPLISHMENTS; DELINQUENCIES; STATISTICS (For Delinquencies and Statistics for Foreign Offices use Administrative File).....	66-2362
ACCOUNTING.....	66-6300
ADEX; ADMINISTRATIVE INDEX; SECURITY INDEX; SECURITY INVESTIGATION OF INDIVIDUALS.....	100-358086
ANAGRAM (Carry Through).....	65-62456
ANTI-SEMITIC OUTBREAKS; ANTI-JEWISH OUTBREAKS; ANTI-RELIGIOUS OUTBREAKS.....	157-3
ARAB ACTIVITIES IN THE UNITED STATES; ARAB ACTIVITIES.....	105-194289
ASSIGNMENT OF INVESTIGATIVE WORK TO POLICE; FBI LAW ENFORCEMENT CONFERENCES.....	66-9340
ATTICA BRIGADE; A.B.; REVOLUTIONARY STUDENT BRIGADE; R.S.B. (No sub for Chicago).....	100-471207
BANK ROBBERY SUSPECT FILE (See instruction card).....	91-1419
BIOGRAPHIC HANDBOOK PROGRAM; BIOGRAPHIC INTELLIGENCE BULLETIN (Foreign subs only).....	64-35693
BLACK EXTREMIST ACTIVITIES; BLACK EXTREMIST FUNDS; BLACK EXTREMIST MOVEMENT - FUNDS; BLACK NATIONALIST MOVEMENT; BLACK NATIONALIST MOVEMENT IN THE UNITED STATES.....	157-8415
BLACK PANTHER PARTY; BLACK PANTHER PARTY FOR SELF-DEFENSE; NATIONAL COMMITTEE TO FIGHT FASCISM; NATIONAL COMMITTEE TO COMBAT FASCISM (No sub for San Francisco).....	105-165706
BOOKMAKING AND CROOKED GAMBLING DEVICES; GAMBLING PARAPHERNALIA; GAMBLING REFERENCE AND PARAPHERNALIA FILE (Use subs for foreign countries also).....	80-634
BUCOMSEC (Code Word); BUREAU COMMUNICATIONS SECURITY CUSTODIAN SYSTEM; COMSEC - CUSTODIAN SYSTEM (Legal Attaches - use sub for country where Legat is located) (Carry Through).....	66-19148
BUREAU CODES (Legal Attaches - use sub for Foreign Country where Legat is located).....	66-629
BUREAU WAR PLANS; BUPLANS (For Legal Attaches use sub for country where Legat is located).....	66-17380
C. W. NETWORK.....	80-646
CHINESE ACTIVITIES; CHINESE COMMUNIST ACTIVITIES (United States and Foreign Countries).....	100-40
CHINESE COMMUNIST INTELLIGENCE OPERATIONS IN FOREIGN COUNTRIES.....	65-65807
CITIZENS COUNCILS.....	105-34237
CIVIL UNREST; EXTREMIST MATTERS; E. M.; EXTREMIST SITUATION; SEGREGATION.....	157-6
COMMUNIST PARTY (Foreign only, including San Juan) (Do not use sub 240 for Russia, - use 61-16; do not use sub 246 for China, use 100-40-246).....	64-200
COMMUNIST PARTY FUNDS.....	100-3-62
COMMUNIST PARTY MEXICO.....	64-200-22

1/13/75

CONFERENCES FOR SPECIAL AGENTS (For Foreign Offices, use Administrative File)	1-27.
CONFERENCES OF NIC, G-2, OSI, AND FBI (NIC, SID, and FBI). (INTERNAL SECURITY QUARTERLY CONFERENCES; INTELLIGENCE CONFERENCES AT FBI)	66-8603-1 66-8603
CONFIDENTIAL INFORMANTS	
CONFIDENTIAL INFORMANTS S.I.S.	64-4123
CRIMINAL INFORMANTS	66-2542-1
PLANT INFORMANTS (CLOSED)	66-2542-2
EXTREMIST INFORMANTS	66-2542-10
SECURITY INFORMANTS	66-2542-3
TOP ECHELON CRIMINAL INFORMANTS (T.E.C.I.P.)	66-2542-11
CONGRESS OF AFRICAN PEOPLES; CONGRESS OF AFRICAN PEOPLE ..	157-16554
CONGRESS OF RACIAL EQUALITY; CONGRESS ON RACIAL EQUALITY; COMMITTEE ON RACIAL EQUALITY; C.O.R.E. (Do not use sub 34 for N.Y.)	100-225892
(CONTINGENCY PLANS ACT FOR THE PROTECTION OF FOREIGN OFFICIALS AND OFFICIAL GUESTS OF THE UNITED STATES (United States and Foreign Countries).....	185-1
CRIMINAL ELEMENT IN BUSINESS FIELD	62-302
CRIMINAL INTELLIGENCE PROGRAM	62-9
CUBAN SUBVERSION TOWARD LATIN AND SOUTH AMERICA; CUBAN SUBVERSION IN FOREIGN COUNTRIES (Foreign Only)	109-653
DEFECTORS (Foreign Only)	100-357681
DELEGATION TO THE UNITED NATIONS; UNITED NATIONS PERSONNEL (Foreign subs only)	62-77787
DELINQUENCIES; ACCOMPLISHMENTS; STATISTICS; DELINQUENCY ..	66-2362
DEMONSTRATIONS PROTESTING U.S. INTERVENTION IN VIET NAM; VIDEM (Code Word)	105-138315
DESTRUCTION OF BUREAU PROPERTY; DESTRUCTION OF BUREAU RECORDS (For Foreign Offices use Administrative File)	66-3286
DIPLOMATIC LIST (Foreign subs only)	62-6404
ECONOMIC MATTERS (Foreign subs only)	110-6
ELECTRONIC PENETRATION OF COMMUNICATIONS EQUIPMENT; ELECTRONIC PENETRATION OF CODE MACHINES AND TYPE- WRITERS; "ENGULF"; "CATALAN"; E.P.C.E. (Foreign subs only)	80-815
EMPLOYMENT - CIVIL RIGHTS ACT OF 1964	173-2
EXCHANGE OF CULTURAL RELATIONS; EDUCATIONAL EXCHANGE (Foreign subs only)	64-25441
EXTORTIONATE CREDIT TRANSACTIONS	179-16
EXTREMIST MATTERS; SEGREGATION; EXTREMIST SITUATION; CIVIL UNREST; E.M.	157-6
F.B.I. LAW ENFORCEMENT CONFERENCES; POLICE CONFERENCE	66-9340
(EXTREMIST, REVOLUTIONARY, TERRORIST AND SUBVERSIVE ACTIVITIES IN PENAL INSTITUTIONS.....	62-116018

12-10-74

STANDARD SUB LIST

-3-

F. M. RADIO STATION (See other captions on list).....	80-648
FEDERAL GRAND JURIES INVESTIGATING LOCAL CRIME.....	62-96173
FIREARMS TRAINING (For Foreign Offices use Administrative File).....	1-29
FIXED F. M. STATIONS (See other captions on list).....	80-648
FOREIGN FUNDS OUTSIDE THE UNITED STATES.....	112-8
FOREIGN INTELLIGENCE MATTERS (Foreign subs only).....	65-63987
FOREIGN MISCELLANEOUS (Foreign subs only).....	64-175
FOURTH INTERNATIONAL (Foreign countries only).....	64-532
GAMBLING INVESTIGATIONS.....	162-1
GAMBLING PARAPHERNALIA; GAMBLING REFERENCE AND PARAPHERNALIA FILE (Foreign subs also).....	80-634
HATE AND KLAN ORGANIZATIONS.....	157-5
HATE AND KLAN ORGANIZATIONS; EXTREMIST MATTERS (Administrative).....	157-1
INQUIRIES TO STATE DEPARTMENT BY AMERICANS RE RELATIVES PROPERTY AND FUNDS IN FOREIGN COUNTRIES (Foreign subs only) (See other captions on list).....	64-27223
(INTERNATIONAL COMMUNIST MOVEMENT (No subs - See instruction card).....	64-200
INTERSTATE GAMBLING ACTIVITIES - WIRE SERVICE.....	162-1
JEWEL THEFT INVESTIGATIONS (Control File).....	87-12304
KOREAN ACTIVITIES (Do not use foreign subs).....	100-25
LABOR CONDITIONS IN FOREIGN COUNTRIES.....	100-341561
LEGAL INSTRUCTION; LEGAL PROBLEMS.....	66-19123
MILITARY AND NAVAL MATTERS (Foreign Countries Only).....	113-7
MINUTEMEN; MINUTE MEN (No sub for Kansas City).....	62-107261
MISSING FILES; MISSING SERIALS (Foreign offices use Administrative File).....	66-18090
(MISSION TO THE UNITED NATIONS (Foreign subs only).....	62-77787
MORINE (Foreign subs only, Carry Thru Mail).....	105-87025
(NATION OF ISLAM (No sub for Chicago) (F. O. and foreign subs).....	25-330971
NATIONALITY GROUP COVERAGE (Foreign subs only).....	105-97459
NATIONAL INTELLIGENCE SURVEY (Foreign subs only).....	64-35693
(POLICE MATTERS (Foreign subs only) (Do not use for Puerto Rico, Alaska and Hawaii) (See instruction card "Foreign Police Matters")..	64-29833
POLICE RADIOS IN BUREAU CARS; PORAD (Code Word).....	80-754
POLICE TRAINING SCHOOL; POLICE TRAINING.....	1-1152
POLITICAL MATTERS (Foreign subs only).....	109-12
PROGRESSIVE LABOR PARTY; PROGRESSIVE LABOR MOVEMENT; PROGRESSIVE LABOR (Do not use sub 34 for N. Y.).....	100-437041
*PROSAB; PROTECTION OF STRATEGIC AIR COMMAND BASES OF U. S. AIR FORCE.....	98-38030
PUBLIC ACCOMMODATIONS, CRA-1964; PUBLIC FACILITIES, CRA-1964.....	173-1
(PFISACTS (Code Word)	62-116018

STANDARD SUB LIST

-4-

PUBLIC EDUCATION CRA-1964.....	173-4
REQUESTS FOR INFORMATION FROM FOREIGN COUNTRIES OF PEN FRIENDS; INQUIRIES TO STATE DEPARTMENT BY AMERICANS RE RELATIVES, PROPERTY, AND FUNDS IN FOREIGN COUNTRIES(Foreign subs only) (See other captions on list).....	64-27223
RESISTANCE.....	14-2965
REVOLUTIONARY ACTIVITIES (Use Foreign Subs also).....	100-446997
REVOLUTIONARY STUDENT BRIGADE; R.S.B.; ATTICA BRIGADE; A.B. (No sub for Chicago).....	100-471207
REVOLUTIONARY UNION; RED UNION.....	105-184369
SECURITY INVESTIGATION OF INDIVIDUALS; ADMINISTRATIVE INDEX; ADEX.....	100-358086
SEX OFFENDERS (No foreign subs).....	105-34074
SMUGGLING ACTIVITIES (Foreign subs only).....	64-309
SOCIAL CONDITIONS (Foreign subs only).....	111-1
SODAC; SOVIET DIPLOMATIC ACTIVITIES; SOVIET ACTIVITIES (Foreign subs only).....	64-211
SOVIET INTELLIGENCE SERVICES (Operations Abroad) (Use subs for Country of Legat Offices only).....	65-71723
SPEAKING ENGAGEMENTS; SPEECH MANUSCRIPTS; SPEECH MATTERS; SPEECH OUTLINES.....	94-9
SPECIAL AGENTS CONFERENCE (Foreign Offices use Administrative File).....	1-27
STATISTICS; ACCOMPLISHMENTS; DELINQUENCIES.....	66-2362
STUDENT AGITATION; STUDENT AGITATION ON COLLEGE CAMPUSES; (No foreign subs); STAG (Code Work).....	62-112228
STUDENT MOBILIZATION COMMITTEE; STUDENT MOBILIZATION COMMITTEE TO END THE WAR IN VIETNAM.....	100-446761
STUDENT NON-VIOLENT COORDINATING COMMITTEE (SNCC); STUDENT NATIONAL COORDINATING COMMITTEE.....	100-439190
STUDENTS FOR A DEMOCRATIC SOCIETY; S.D.S.; WEATHERMEN.....	100-439048
SUSPECTS PROGRAM - BANK ROBBERY MATTERS (See instruction card)....	91-1419
TECHNICAL SURVEILLANCE; TECHNICAL SURVEILLANCES (Use sub for NEW YORK only).....	66-8160
TOP HOODLUM COVERAGE; TOP HOODLUM PROGRAM.....	62-9
TOP THIEF PROGRAM.....	87-12304
250-WATT F.M. CENTRAL STATIONS AND REMOTE RECEIVERS; F.M. RADIO STATION (See other captions on list).....	80-648
UNITED KLANS OF AMERICA (Use sub for source of mail).....	157-370
UNITED NATIONS PERSONNEL: DELEGATION TO THE UNITED NATIONS; MISSION TO THE UNITED NATIONS (Foreign subs only).....	62-77787
U. S. KLANS.....	100-7801
UNSOLVED BANK BURGLARIES.....	91-1419
VIDEM (Demonstrations Protesting U.S. Intervention in Vietnam)....	105-138315
VISA APPLICANTS (Foreign subs only).....	105-7
VISAS (Form I-57only) (Foreign subs only).....	105-1
WEATHERMEN: STUDENTS FOR A DEMOCRATIC SOCIETY; S.D.S.	100-439048
WHITE SLAVE TRAFFIC ACT SURVEY.....	66-2341

STANDARD SUB LIST

-5-

WORKERS PARTY; INDEPENDENT SOCIALIST LEAGUE..... 100-86590
YOUNG SOCIALIST ALLIANCE; YOUNG SOCIALISTS ALLIANCE;
Y. S. A. (no sub for N. Y.)..... 100-427226
YOUNG WORKERS LIBERATION LEAGUE; YOUNG COMMUNIST WORKERS
LIBERATION LEAGUE (Use all field office subs)..... 100-455711

STANDARD SURVEILLANCE LIST FOR U.S. & FOREIGN COUNTRIES

FIELD OFFICES

ALBANY	1	HUNTINGTON (CLOSED)	20
ALBUQUERQUE	62	INDIANAPOLIS	21
ALEXANDRIA	101	JACKSON	54
ANCHORAGE	22	JACKSONVILLE	63
ATLANTA	2	KANSAS CITY	23
BALTIMORE	3	KNOXVILLE	24
BIRMINGHAM	4	LAS VEGAS	65
BOSTON	5	LITTLE ROCK	25
BUFFALO	6	LOS ANGELES	26
BUTTE	7	LOUISVILLE	27
CANAL ZONE (CLOSED)	59	MEMPHIS	28
CHARLOTTE	8	MIAMI	29
CHICAGO	9	MILWAUKEE	30
CINCINNATI	10	MINNEAPOLIS (Formerly St. Paul)	43
CLEVELAND	11	MOBILE	61
COLUMBIA	66	NASHVILLE (CLOSED)	57
DALLAS	12	NEWARK	31
DENVER	13	NEW HAVEN	32
DES MOINES (CLOSED)	14	NEW ORLEANS	33
DETROIT	15	NEW YORK	34
EL PASO	16	NORFOLK	56
GRAND RAPIDS (CLOSED)	17	OKLAHOMA CITY	35
HARTFORD (CLOSED)	58	OMAHA	36
HONOLULU	18	PHILADELPHIA	37
HOUSTON	19	PHOENIX	38

4/10/70

PITTSBURGH	39	SAN FRANCISCO	47
PORTLAND	40	SAN JUAN	48
PROVIDENCE (CLOSED)	55	SAVANNAH	49
RICHMOND	41	SEATTLE	50
SACRAMENTO	67	SIOUX FALLS (CLOSED)	51
SAINT LOUIS	42	SPRINGFIELD	52
SALT LAKE CITY	44	SYRACUSE (CLOSED)	60
SAN ANTONIO	45	TAMPA	64
SAN DIEGO	46	WASHINGTON, D.C.	53

SUBS UP TO AND INCLUDING 200 ARE
RESERVED FOR FIELD OFFICES TO BE
OPENED IN THE FUTURE.
SUBS BEGINNING WITH 201 ARE FOR
FOREIGN COUNTRIES.

-0-
FOREIGN COUNTRIES

(ADEN (closed) Use Democratic Republic of Yemen	395	(BRITISH HONDURAS (BR.HOND.) (NOW BELIZE)	206
AFGHANISTAN (AFG.)	321	BRITISH SOLOMON ISLANDS	409
ALBANIA (ALB.)	273	BRITISH WEST INDIES (BR. W. I.)	324
ALGERIA (ALG.)	278	BULGARIA (BUL.)	261
ANDORRA (AND.)	281	BURMA	264
ANGOLA	380	BURUNDI (URUNDI)	407
ANGUILLA	418	BYELORUSSIA	329
ARAB REPUBLIC OF EGYPT (Formerly United Arab Republic)	376	CAMBODIA (CAMB.)	364
ARGENTINA	201	CAMEROUN (CAM.)	369
ARMENIA	308	CANADA	243
AUSTRIA (AUS.)	252	<i>Canal Zone</i> CANARY ISLANDS (CAN.IS.)	291
AZORES (AZORES IS.)	310	CAPE VERDE ISLANDS (C.V.IS.)	292
BAHAMA ISLANDS (BA.IS.)	202	CARIBBEAN STATES	422
BAHRAIN (BAHREIN) ISLAND	410	CENTRAFRICAN REPUBLIC	389
BANGLADESH	423	CENTRAL AFRICAN REPUBLIC	
BARBADOS	417	CEYLON (NOW SRI LANKA)	266
BECHUANALAND (BECH.) (NOW BOTSWANA)	404	CHAD	388
BASUTOLAND (NOW LESOTHO)	412	CHILE	207
BELGIUM	254	(CHINA (COMMUNIST) (PEOPLE'S REPUBLIC OF CHINA)	246
(BELIZE	206	(CHINA-NATIONALIST-See Formosa and Republic of China	
BELORUSSIA	329	COLOMBIA (COL.)	208
BERMUDA ISLANDS (IS.)	203	COMORO ISLANDS	424
BHUTAN	371	CONGO (FORMERLY FRENCH; BRAZZAVILLE, CAPITAL)	391
BOLIVIA (BOL.)	204	CONGO REPUBLIC (Formerly Belgian) (Leopoldville	336
BORNEO	293		
BRAZIL	205	COSTA RICA (C.R.)	209

CROATIA (CLOSED USE YUGO.)		FRANCE	231
CUBA	210	FRENCH WEST AFRICA (FR. W. AFR.)	343
CURACAO	298		
CYPRUS	277	* FRENCH INDO-CHINA (FR. INDOCH.)	270
CZECHOSLOVAKIA (CZECH.)	263	FRENCH WEST INDIES	341
DAHOMEY	385	GABON	392
DANZIG	309	GAMBIA	401
DEMOCRATIC PEOPLE'S REPUBLIC OF KOREA (NORTH KOREA)	381	GERMAN DEMOCRATIC REPUBLIC	397
(DEMOCRATIC REPUBLIC OF YEMEN ^{YEMEN} YEMEN)	425	GERMANY (GER.) (FEDERAL REPUBLIC OF GERMANY)	232
DENMARK (DEN.)	256	GHANA (GOLD COAST)	366
DOMINICAN REPUBLIC (DOM. REP.)	211	GOLD COAST (GHANA) (G.C.)	366
EAST GERMANY (GERMAN DEMOCRATIC REPUBLIC)	397	GREECE	252
ECUADOR (EC.)	212	GREENLAND (GRNLD.)	360
(EGYPT (CLOSED; SEE ARAB REPUBLIC OF EGYPT)	259	GRENADA	420
EL SALVADOR (EL SAL.)	226	GUAM	333
ENGLAND (ENG.)	241	GUATEMALA (GUAT.)	213
EQUATORIAL GUINEA	377	GUIANA (BRITISH) (BR. GU.) (GUYANA)	214
ESTONIA	283	GUIANA (DUTCH) (SURINAM)	215
* ETHIOPIA (Closed use Ethiopia)	313	GUIANA (FRENCH) (LOCATED IN SOUTH AMERICA)	216
ERITREA	356	GUINEA (FORMERLY FRENCH) (LOCATED IN AFRICA)	378
FAR EAST	352	GUINEA, EQUATORIAL (SPANISH POSSESSION) (RIO MUNI & FERNANDO POO)	377
FEDERAL REPUBLIC OF GERMANY	232	GUINEA (PORTUGUESE)	403
FEDERATION OF RHODESIA AND NYASALAND (CLOSED)	399	GUYANA (FORMERLY BRITISH GUIANA)	214
FIJI ISLANDS (IS.)	402	HAITI	217
FINLAND (FIN.)	255	HONDURAS (HOND.)	218
FORMOSA (TAIWAN) (FOR.)	274		

* See separate subs for Laos, Cambodia, Viet Nam, Viet Minh

1-22-74
*3/5/74

HUNGARY (HUNG.)	249	MALAWI	326
ICELAND (ICE.)	314	MALAYA <i>MALASIA</i>	279
INDIA	257	MALAYSIA	405
INDONESIA (INDON.)	331	MALDIVE ISLANDS	414
IRAN	251	MALI	384
IRAQ	282	MALTA	340
IRELAND (IRE.)	311	MANCHURIA	275
ISRAEL	345	MARIANA ISLANDS (USE TRUST TERRITORIES)	421
ITALY	233	MAURITANIA	398
IVORY COAST	386	MAURITIUS ISLAND	394
JAMAICA (JAM.)	219	MEXICO	221
JAPAN	234	MIDDLE EAST-NEAR EAST	350
JAVA	289	MONACO	363
JORDAN	332	MONGOLIA (MONG.)	271
KENYA	325	MOROCCO (MOR.)	235
(KHMER REPUBLIC	364	MOZAMBIQUE (MOZ.)	276
KUWAIT	367	(MUSCAT & OMAN (NOW OMAN)	419
LAOS	365	NEAR EAST	350
LATVIA	294	NEPAL	353
LEBANON (LEB.)	287	NETHERLANDS (NETH.)	258
LEEWARD ISLANDS (LE.IS.)	220	NETHERLANDS ANTILLES (FORMERLY NETHERLANDS WEST INDIES)	242
LESOTHO	412	NETHERLANDS NEW GUINEA (NOW WEST IRIAN)	357
LIBERIA (LIB.)	297	NEW CALEDONIA (N.CAL.)	269
(LIBYA; LIBYAN ARAB REPUBLIC	300	NEW GUINEA (N.GUI.) (NETHERLANDS OR WEST) (NOW WEST IRIAN)	357
<i>Liechtenstein</i> - - - - -	426	NEW HEBRIDES (NEW HEBR.)	400
LITHUANIA	262	NEW ZEALAND (N.Z.)	350
LUXEMBOURG (LUX.)	280		
MACAO	362		
MADAGASCAR (MADAG.)	350		
MALAGASY REPUBLIC			

NEWFOUNDLAND (NEWF.)	338	SALVADOR, EL (EL SAL.)	226
NICARAGUA (NIC.)	222	SAMOA	358
NIGER	387	SAN MARINO	299
NIGERIA (NIG.)	323	SARDINIA	318
(NORTH KOREA (DEMOCRATIC PEOPLE'S REPUBLIC OF KOREA)	381	SAUDI ARABIA (SAU.AR.)	245
NORTHERN RHODESIA (N.RH.) (REP. OF ZAMBIA)	351	SCOTLAND (SCOT.)	285
NORWAY	260	SENEGAL	393
NYASALAND (NYA.) (NOW MALAWI)	326	SERBIA (CLOSED, USE YUGO.)	348
(OMAN (FORMERLY MUSCAT AND OMAN)	419	SIAM (THAILAND)	288
PAKISTAN (PAK.)	342	SIERRA LEONE (S.L.)	355
PALESTINE	248	SINGAPORE (STRAITS SETTLEMENTS)	316
PANAMA	223	SOLOMON ISLANDS (BRITISH) (SOL.IS.)	409
PAPUA	411	(SOMALI DEMOCRATIC REPUBLIC (SOMALIA)	349
PARAGUAY (PAR.)	224	SOUTH AFRICA (S.AFR.)	317
(PEOPLE'S REPUBLIC OF CHINA	246	(SOUTH KOREA (REPUBLIC OF KOREA)	265
PERU	225	SOUTH WEST AFRICA (S.W. AFR.)	382
PHILIPPINE ISLANDS (PHIL.IS.)	239	SOUTHEAST ASIA	413
POLAND	250	SOUTHERN RHODESIA (S.RH.)	327
PORTUGAL (PORT.)	236	(SRI LANKA (FORMERLY CEYLON)	266
QATAR	415	SPAIN	237
(REPUBLIC OF CHINA (FORMOSA)	274	STATELESS	361
(REPUBLIC OF KOREA (S.KOREA)	265	SUDAN	339
ROMANIA	244	SURINAM (DUTCH GUIANA)	215
RUSSIA	240	SUMATRA	284
RUANDA-URUNDI (CLOSED)	396		
	400		
	368	SWEDEN	267
** PEOPLE'S DEMOCRATIC REPUBLIC OF YEMEN	425		

9-24-73

STANDARD SUB LIST

give full #s 77

ACCIDENTS - FIELD (For Foreign Offices use Administrative File)....	(66-2058)
ACCOMPLISHMENTS - Foreign Offices only - (use sub for country where Legat is located).....	(64-44362)
ACCOMPLISHMENTS; DELINQUENCIES; STATISTICS (For Delinquencies and Statistics for Foreign Offices use Administrative File).....	66-2362
ACCOUNTING.....	66-6300
✓ ADEX; ADMINISTRATIVE INDEX; SECURITY INDEX; SECURITY INVESTIGATION OF INDIVIDUALS.....	100-358086
✓ ANAGRAM (Carry Through).....	65-62456
ANTI-SEMITIC OUTBREAKS; ANTI-JEWISH OUTBREAKS; ANTI-RELIGIOUS OUTBREAKS.....	157-3
ARAB ACTIVITIES IN THE UNITED STATES; ARAB ACTIVITIES.....	105-194289
ASSIGNMENT OF INVESTIGATIVE WORK TO POLICE; FBI LAW ENFORCEMENT CONFERENCES.....	66-9340
ATTICA BRIGADE; A.B.; REVOLUTIONARY STUDENT BRIGADE; R.S.B. (No sub for Chicago).....	100-471207
BANK ROBBERY SUSPECT FILE (See instruction card).....	91-1419
✓ BIOGRAPHIC HANDBOOK PROGRAM; BIOGRAPHIC INTELLIGENCE BULLETIN (Foreign subs only).....	64-35693
BLACK EXTREMIST ACTIVITIES; BLACK EXTREMIST FUNDS; BLACK EXTREMIST MOVEMENT - FUNDS; BLACK NATIONALIST MOVEMENT; BLACK NATIONALIST MOVEMENT IN THE UNITED STATES.....	157-8415
BLACK PANTHER PARTY; BLACK PANTHER PARTY FOR SELF-DEFENSE; NATIONAL COMMITTEE TO FIGHT FASCISM; NATIONAL COMMITTEE TO COMBAT FASCISM (No sub for San Francisco).....	105-165706
BOOKMAKING AND CROOKED GAMBLING DEVICES; GAMBLING PARAPHERNALIA; GAMBLING REFERENCE AND PARAPHERNALIA FILE (Use subs for foreign countries also).....	80-634
✓ BUCOMSEC (Code Word); BUREAU COMMUNICATIONS SECURITY CUSTODIAN SYSTEM; COMSEC - CUSTODIAN SYSTEM (Legal Attaches' - use sub for country where Legat is located) (Carry Through).....	66-19148
✓ BUREAU CODES (Legal Attaches - use sub for Foreign Country where Legat is located).....	66-629
✓ BUREAU WAR PLANS; BUPLANS (For Legal Attaches use sub for country where Legat is located).....	66-17380
✓ C. W. NETWORK.....	80-646
CHINESE ACTIVITIES; CHINESE COMMUNIST ACTIVITIES (United States and Foreign Countries).....	100-40
CHINESE COMMUNIST INTELLIGENCE OPERATIONS IN FOREIGN COUNTRIES.....	65-65807
CITIZENS COUNCILS.....	105-34237
CIVIL UNREST; EXTREMIST MATTERS; E. M.; EXTREMIST SITUATION; SEGREGATION.....	157-6
COMMUNIST PARTY (Foreign only, including San Juan) (Do not use sub 240 for Russia, - use 61-16; do not use sub 246 for China, use 100-40-246).....	64-200
COMMUNIST PARTY FUNDS.....	100-3-63
COMMUNIST PARTY MEXICO.....	64-200-22

STANDARD SUB LIST

-2-

7. CONFERENCES FOR SPECIAL AGENTS (For Foreign Offices, use Administrative File) 1-27
- ✓ CONFERENCES OF NIC, G-2, OSI, AND FBI (NIC, SID, and FBI). 66-8603-1
(INTERNAL SECURITY QUARTERLY CONFERENCES; INTELLIGENCE CONFERENCES AT FBI) 66-8603
- ✓ CONFIDENTIAL INFORMANTS
- CONFIDENTIAL INFORMANTS S.I.S. 64-4123
- CRIMINAL INFORMANTS 66-2542-1
- PLANT INFORMANTS (CLOSED) 66-2542-2
- EXTREMIST INFORMANTS 66-2542-10
- SECURITY INFORMANTS 66-2542-3
- TOP ECHELON CRIMINAL INFORMANTS (T.E.C.I.P.) 66-2542-11
- CONGRESS OF AFRICAN PEOPLES; CONGRESS OF AFRICAN PEOPLE .. 157-16554
- CONGRESS OF RACIAL EQUALITY; CONGRESS ON RACIAL EQUALITY;
COMMITTEE ON RACIAL EQUALITY; C.O.R.E. (Do not use
sub 34 for N.Y.) 100-225892
- (CONTINGENCY PLANS ACT FOR THE PROTECTION OF FOREIGN
OFFICIALS AND OFFICIAL GUESTS OF THE UNITED STATES
(United States and Foreign Countries)..... 185-1
- CRIMINAL ELEMENT IN BUSINESS FIELD 62-302
- CRIMINAL INTELLIGENCE PROGRAM 62-9
- CUBAN SUBVERSION TOWARD LATIN AND SOUTH AMERICA; CUBAN
SUBVERSION IN FOREIGN COUNTRIES (Foreign Only) 109-653
- DEFECTORS (Foreign Only) 100-357681
- DELEGATION TO THE UNITED NATIONS; UNITED NATIONS
PERSONNEL (Foreign subs only) 62-77787
- DELINQUENCIES; ACCOMPLISHMENTS; STATISTICS; DELINQUENCY .. 66-2362
- DEMONSTRATIONS PROTESTING U.S. INTERVENTION IN VIET NAM;
VIDEM (Code Word) 105-138315
- DESTRUCTION OF BUREAU PROPERTY; DESTRUCTION OF BUREAU
RECORDS (For Foreign Offices use Administrative
File) 66-3286
- DIPLOMATIC LIST (Foreign subs only) 62-6404
- ECONOMIC MATTERS (Foreign subs only) 110-6
- ✓ ELECTRONIC PENETRATION OF COMMUNICATIONS EQUIPMENT;
ELECTRONIC PENETRATION OF CODE MACHINES AND TYPE-
WRITERS; "ENGULF"; "CATALAN"; E.P.C.E. (Foreign
subs only) 80-815
- EMPLOYMENT - CIVIL RIGHTS ACT OF 1964 173-2
- EXCHANGE OF CULTURAL RELATIONS; EDUCATIONAL EXCHANGE
(Foreign subs only) 64-25441
- EXTORTIONATE CREDIT TRANSACTIONS 179-16
- EXTREMIST MATTERS; SEGREGATION; EXTREMIST SITUATION;
CIVIL UNREST; E.M. 157-6
- F.B.I. LAW ENFORCEMENT CONFERENCES; POLICE CONFERENCE 66-9340
- (EXTREMIST, REVOLUTIONARY, TERRORIST AND SUBVERSIVE
ACTIVITIES IN PENAL INSTITUTIONS..... 62-116018

12-10-74

✓ F. M. RADIO STATION (See other captions on list).....	80-648
FEDERAL GRAND JURIES INVESTIGATING LOCAL CRIME.....	62-96173
FIREARMS TRAINING (For Foreign Offices use Administrative File).....	1-29
✓ FIXED F. M. STATIONS (See other captions on list).....	80-648
FOREIGN FUNDS OUTSIDE THE UNITED STATES.....	112-8
FOREIGN INTELLIGENCE MATTERS (Foreign subs only).....	65-63987
FOREIGN MISCELLANEOUS (Foreign subs only).....	64-175
FOURTH INTERNATIONAL (Foreign countries only).....	64-532
GAMBLING INVESTIGATIONS.....	162-1
GAMBLING PARAPHERNALIA; GAMBLING REFERENCE AND PARAPHERNALIA FILE (Foreign subs also).....	80-634
HATE AND KLAN ORGANIZATIONS.....	157-5
HATE AND KLAN ORGANIZATIONS; EXTREMIST MATTERS (Administrative).....	157-1
INQUIRIES TO STATE DEPARTMENT BY AMERICANS RE RELATIVES PROPERTY AND FUNDS IN FOREIGN COUNTRIES (Foreign subs only) (See other captions on list).....	64-27223
(INTERNATIONAL COMMUNIST MOVEMENT (No subs - See instruction card).....	64-200
INTERSTATE GAMBLING ACTIVITIES - WIRE SERVICE.....	162-1
JEWEL THEFT INVESTIGATIONS (Control File).....	87-12304
KOREAN ACTIVITIES (Do not use foreign subs).....	100-25
LABOR CONDITIONS IN FOREIGN COUNTRIES.....	100-341561
LEGAL INSTRUCTION; LEGAL PROBLEMS.....	66-19123
MILITARY AND NAVAL MATTERS (Foreign Countries Only).....	113-7
MINUTEMEN; MINUTE MEN (No sub for Kansas City).....	62-107261
MISSING FILES; MISSING SERIALS (Foreign offices use Administrative File).....	66-18090
(MISSION TO THE UNITED NATIONS (Foreign subs only).....	62-77787
✓ MORINE (Foreign subs only, Carry Thru Mail).....	105-87025
(NATION OF ISLAM (No sub for Chicago) (F. O. and foreign subs).....	25-330971
NATIONALITY GROUP COVERAGE (Foreign subs only).....	105-97459
NATIONAL INTELLIGENCE SURVEY (Foreign subs only).....	64-35693
(POLICE MATTERS (Foreign subs only) (Do not use for Puerto Rico, Alaska and Hawaii) (See instruction card "Foreign Police Matters")..	64-29833
POLICE RADIOS IN BUREAU CARS; PORAD (Code Word).....	80-754
POLICE TRAINING SCHOOL; POLICE TRAINING.....	1-1152
POLITICAL MATTERS (Foreign subs only).....	109-12
PROGRESSIVE LABOR PARTY; PROGRESSIVE LABOR MOVEMENT; PROGRESSIVE LABOR (Do not use sub 34 for N. Y.).....	100-437041
✓ *PROSAB; PROTECTION OF STRATEGIC AIR COMMAND BASES OF U. S. AIR FORCE.....	98-38030

(PFISACTS (Code Word) 62-116018

STANDARD SUB LIST

PUBLIC EDUCATION CRA-1964.....173-4

REQUESTS FOR INFORMATION FROM FOREIGN COUNTRIES OF PEN FRIENDS;
INQUIRIES TO STATE DEPARTMENT BY AMERICANS RE RELATIVES,
PROPERTY, AND FUNDS IN FOREIGN COUNTRIES(Foreign subs only)
(See other captions on list).....64-27223

RESISTANCE.....14-2965

REVOLUTIONARY ACTIVITIES (Use Foreign Subs also).....100-446997

REVOLUTIONARY STUDENT BRIGADE; R.S.B.; ATTICA BRIGADE; A.B.
(No sub for Chicago).....100-471207

REVOLUTIONARY UNION; RED UNION.....105-184369

SECURITY INVESTIGATION OF INDIVIDUALS; ADMINISTRATIVE INDEX;
ADEX.....100-358086

SEX OFFENDERS (No foreign subs).....105-34074

SMUGGLING ACTIVITIES (Foreign subs only).....64-309

SOCIAL CONDITIONS (Foreign subs only).....111-1

SODAC; SOVIET DIPLOMATIC ACTIVITIES; SOVIET ACTIVITIES
(Foreign subs only).....64-211

SOVIET INTELLIGENCE SERVICES (Operations Abroad) (Use subs for
Country of Legat Offices only).....65-71723

SPEAKING ENGAGEMENTS; SPEECH MANUSCRIPTS; SPEECH MATTERS; SPEECH
OUTLINES.....94-9

SPECIAL AGENTS CONFERENCE (Foreign Offices use Administrative
File).....1-27

STATISTICS; ACCOMPLISHMENTS; DELINQUENCIES.....66-2362

STUDENT AGITATION; STUDENT AGITATION ON COLLEGE CAMPUSES;
(No foreign subs); STAG (Code Work).....62-112228

STUDENT MOBILIZATION COMMITTEE; STUDENT MOBILIZATION COMMITTEE
TO END THE WAR IN VIETNAM.....100-446761

STUDENT NON-VIOLENT COORDINATING COMMITTEE (SNCC);
STUDENT NATIONAL COORDINATING COMMITTEE.....100-439190

STUDENTS FOR A DEMOCRATIC SOCIETY; S.D.S.; WEATHERMEN.....100-439048

SUSPECTS PROGRAM - BANK ROBBERY MATTERS (See instruction card).....91-1419

TECHNICAL SURVEILLANCE; TECHNICAL SURVEILLANCES (Use sub for
NEW YORK only).....66-8160

TOP HOODLUM COVERAGE; TOP HOODLUM PROGRAM.....62-9

TOP THIEF PROGRAM.....87-12304

250-WATT F.M. CENTRAL STATIONS AND REMOTE RECEIVERS; F.M. RADIO
STATION (See other captions on list).....80-648

UNITED KLANS OF AMERICA (Use sub for source of mail).....157-370

UNITED NATIONS PERSONNEL: DELEGATION TO THE UNITED NATIONS;
MISSION TO THE UNITED NATIONS (Foreign subs only).....62-77787

U. S. KLANS.....100-7801

UNSOLVED BANK BURGLARIES.....91-1419

VIDEM (Demonstrations Protesting U.S. Intervention in Vietnam).....105-138315

VISA APPLICANTS (Foreign subs only).....105-7

VISAS (Form I-57 only) (Foreign subs only).....105-1

STANDARD SUB LIST

WORKERS PARTY; INDEPENDENT SOCIALIST LEAGUE..... 100-86590
YOUNG SOCIALIST ALLIANCE; YOUNG SOCIALISTS ALLIANCE;
Y. S. A. (no sub for N. Y.)..... 100-427226
YOUNG WORKERS LIBERATION LEAGUE; YOUNG COMMUNIST WORKERS
LIBERATION LEAGUE (Use all field office subs)..... 100-455711

8/5/75 request

III - D - 8



274-10128

UNITED STATES GOVERNMENT

Memorandum

Tolson	_____
Felt	_____
Sullivan	_____
Mohr	_____
Bishop	_____
Callahan	_____
Casper	_____
Conrad	_____
Dalbey	_____
Galbo	_____
Rogler	_____
Rosen	_____
Tavel	_____
Walters	_____
Soyars	_____
Tele. Room	_____
Holmes	_____
Gandy	_____

TO : MR. TOLSON

SECRET

DATE: August 31, 1971

FROM : J. K. PONDER

SUBJECT: INSPECTION - OFFICE OF LEGAL ATTACHE

BEIRUT, LEBANON
INSPECTOR PAUL J. MOHR
8/9 - 13/71

NATIONAL SECURITY INFORMATION
Unauthorized Disclosure
Subject to Criminal Sanctions
SUMMARY

Official: Theodore A. Korontjis, Legal Attache (Legat) since 12/18/70. First inspection; office opened 12/18/70 at time of expansion of foreign offices.

Physical Condition and Maintenance - Excellent. The new office of the Legal Attache is located on the 5th floor of the American Embassy, which is convenient to police, agency, and key contacts; well organized, attractive and operating efficiently. No Bureau automobiles. Security regulations receiving close attention.

Investigative Operations - Excellent. Office covers only Lebanon. Active case load 7/31/71 - 26. Delinquency consistently low. 1 Bureau subject located. No recoveries or deportations effected. Office established primarily for purpose of collecting high-level political intelligence for dissemination to the White House. Legat highly successful in this assignment. From January, 1971, to July, 1971, Beirut Office submitted 53 items for possible dissemination - 29 sent to White House. Total items submitted and number disseminated rank high among all Legats. Legat encouraged to continue. No substantive errors detected.

Administrative Operations - Very Good. Chief Clerk's Office functioning efficiently and well organized. No misfiled index cards detected and form errors low. Project and pending work current. Retypes low, stenographic production high. Confidential expenditures controlled closely.

Personnel Matters - Excellent. Present complement of one Agent and one clerk-stenographer considered adequate. Legat instructed to follow work load closely. Legat not overweight, on limited duty, probation or unavailable. Morale high. Overtime productive and essential.

Enclosure sent 9-1-71

- 1 - Mr. Callahan (Attention Mr. H. N. Bassett) (Sent Separately)
- 1 - Mr. Brennan (Attention Foreign Liaison Desk) (Sent Separately)
- 1 - Personnel File Theodore A. Korontjis

PJM:bhg (6) 1971

Classified by 6283
Exempt from GDS, Category 3
Date of Declassification Indefinite

CONTINUED OVER

274-10128

4/18

Memorandum to Mr. Tolson
Re: Inspection - Office of Legal Attache, Beirut

SECRET

Contacts - Excellent. Legat, in 8 months, overcoming obstacles of opening a new office, developed a wide range of contacts in police and government agencies. In addition Legat developed several high-level confidential sources who furnish high volume of intelligence information. Has interested Lebanese police in National Academy and instrumental in having 2 Lebanese police officers attend 88th Session of FBI National Academy. Officials contacted by Inspector warmly praised Director, FBI and Beirut Office personnel. Dr. Charles Malik, former President of United Nations General Assembly and now professor, American University of Beirut, was highly complimentary concerning Director and stated he has read all the Director's books and concurred with Director's anti-communist stance.

RECOMMENDATIONS

1. Theodore A. Korontjis, GS-15 at \$25,867, aged 42, veteran, fully available, not on probation. Legal Attache Beirut since 12/18/70. Korontjis is an enthusiastic, dedicated, hard-working Agent. He has an excellent personality, aggressive and highly respected. Makes an excellent appearance and is unusually effective in developing contacts under difficult circumstances. Fully qualified to continue as Legat. A letter is attached for approval summarizing the inspection findings.

OK -
A

P
m

2. In view of highly successful results in obtaining items of high-level political intelligence information which have been disseminated to White House, it is recommended the Beirut Office be continued.

OK -
A

V

7

P
m

SECRET

UNITED STATES GOVERNMENT

Memorandum

SECRET

DATE: September 1, 1971

- Tolson _____
- Felt _____
- Sullivan _____
- Mohr _____
- Bishop _____
- Casper _____
- Callahan _____
- Conrad _____
- DeLoach _____
- Malone _____
- Rosen _____
- Tavel _____
- Walters _____
- Soyars _____
- Tele. Room _____
- Holmes _____
- Gandy _____

TO : MR. TOLSON

FROM : J. K. PONDER

SUBJECT: Inspection
INSPECTION - OFFICE OF LEGAL ATTACHE
COPENHAGEN, DENMARK
INSPECTOR FLETCHER D. THOMPSON
8/23 - 26/71

NATIONAL SECURITY INFORMATION
Unauthorized Disclosure
Subject to Criminal Sanctions

SUMMARY

Officials: Richard E. Potocki, Legal Attache (Legat) since 7/6/71 (SA Lawrence McWilliams Legat 12/21/70 - date office opened until 7/5/71); Bertil W. Rolander, Assistant Legat since 12/21/70. No previous inspection.

Physical Condition and Maintenance - Very Good. Moved into permanent space third floor, American Embassy, in downtown Copenhagen 8/20/71. When vault completed (now under construction), will meet security requirements. Space convenient to Embassy officials and communications center; well maintained. One security violation since office opened (former Legat solely responsible and transferred). All personnel very security conscious. Absolute necessity for strict adherence to all security regulations strongly emphasized by Inspector. Marine Guard on duty on third floor near our office during working hours and in lobby at other times. Periodic security checks made. No Bureau cars assigned.

Investigative Operations - Very Good. Territory, previously handled out of London, covers Denmark, Finland, Norway and Sweden. Active case load of 91 at time of inspection is still below average, but up from 26 in January, 1971. Case closings likewise below average; delinquency low. Accomplishments during first 7 months of operation included 31 fugitives and/or Selective Service delinquents located and one deportation effected. Three of our Security Index subjects visited in countries covered by office during this period and 13 other security subjects reside in territory. Foreign agencies keeping office advised of movements and activities. Legat establishing direct and personal exchange of security and intelligence information with officials in Finland, Norway and Sweden (liaison previously handled through diplomatic channels). This regular personal contact will enhance opportunity for developing high-level (HILEV) intelligence and other information of interest to Bureau. Specific instructions issued regarding need for alertness to Soviet intelligence activities in territory, noting that Soviets have utilized

Enclosure *sent. 9-2-71*

- 1 - Mr. Callahan (Attention Mr. H. N. Bassett) (Sent Separately)
- 1 - Mr. Brennan (Attention Foreign Liaison Desk) (Sent Separately)
- 1 - Personnel Files Richard E. Potocki and Bertil W. Rolander

Classified by *5-Heff*
Exempt from GDS, Category *3*
Date of Declassification Indefinite

FDT:bhg (6) 1971 96

CONTINUED - OVER

SECRET

274-10128

Memorandum to Mr. Tolson

Re: Inspection - Office of Legal Attache, Copenhagen **SECRET**

Scandinavian countries in the past to initiate operations against the United States; similar instructions issued concerning the Chinese communists. Danish Security Service recently furnished information of value concerning Soviet KGB officer who passed through Denmark. Since Scandinavian countries are recognized haven for draft dodgers and New Left fugitives, Inspector instructed Legat to request background data and photographs of extremist fugitives for alerting cooperative police services in territory. Office is showing steady improvement in providing HILEV information. Only 4 items worthy of dissemination to White House submitted 1/1 - 7/31/71, but 3 such items furnished in August for total of 7. Inspector placed strong emphasis on this phase of Legat's responsibilities. Legat and Assistant recognize importance and have specific plans for expansion of program. Legat of definite opinion majority of accomplishments to date achieved only because of personal contact by our Agents. This is especially noticeable in our Selective Service and Deserter cases in Sweden, where 21 Bureau fugitives and 7 Selective Service delinquents have been located even though official government position is to provide asylum for persons who refuse military service for "humanitarian or political reasons." No substantive errors detected.

Administrative Operations - Excellent. Legat is capably administering office, with Chief Clerk's Office running smoothly and work current; stenographic production above average. Continued close attention to all administrative operations emphasized by Inspector.

Personnel Matters - Very Good. Personnel complement of 2 Agents and 2 clerks stenographers. Case load per Agent below average, but substantial increase each month (up from 43 on 6/30/71 to 91 as of 8/25/71). Considering case load, geographical area covered, potential for HILEV and other factors, present complement considered adequate but not excessive to handle responsibilities at this time. Legat instructed to follow closely. Both Agents available; neither overweight or on limited duty. Morale appears high.

Contacts - Excellent. Effective liaison program in effect and being expanded with a number of new contacts established since office opened; others previously developed are becoming more productive. Contacts are diversified; both American and foreign; and are scattered throughout territory covered. All met by Inspector expressed highest regard for Director and FBI as well as our local personnel, and expressed appreciation for having Bureau representatives in Copenhagen.

RECOMMENDATIONS

1. Richard E. Potocki, GS-15 at \$26,675, aged 47, veteran, completely available, not on probation, previously Assistant Legat at Paris; makes excellent

- 2 - CONTINUED - OVER
SECRET

Memorandum to Mr. Tolson

Re: Inspection - Office of Legal Attache, Copenhagen

SECRET

personal appearance, enthusiastic, and confident he can produce desired results in assignment. Respected by working associates and others with whom he does business. Qualified to continue as Legat. Attached for approval is letter to Potocki summarizing inspection findings.

Pm

*OK
h*

2. Bertil W. Rolander, GS-14 at \$23,591, aged 45, veteran, completely available, not on probation, Assistant Legat since 12/21/70 (first foreign assignment). Rolander makes excellent impression, is hard worker and is capably absorbing and discharging responsibilities. Qualified to continue as Assistant Legat.

Pm

*OK
h*

3. This office was opened on 12/21/70 with a complement of 2 Agents and 2 clerk-stenographers. The case load and the accomplishments have shown a steady improvement and this favorable trend is now gaining momentum. The results to date in all areas, including HILEV, and the potential for the future are encouraging. It is recommended, therefore, that the Office of Legal Attache in Copenhagen be continued with the present complement of 2 Agents and 2 clerk-stenographers.

✓

7

Am Pm

*OK
h*

SECRET

UNITED STATES GOVERNMENT

Memorandum

Tolson	_____
Felt	_____
Sullivan	_____
Mohr	_____
Bishop	_____
Brennan	_____
Callahan	_____
Casper	_____
Conrad	_____
Dalbey	_____
Gale	_____
Ponder	_____
Rosen	_____
Tavel	_____
Walters	_____
Soyars	_____
Tele. Room	_____
Holmes	_____
Gandy	_____

TO : MR. TOLSON

DATE: August 31, 1971

SECRET

FROM : J. K. PONDER

SUBJECT: INSPECTION - OFFICE OF LEGAL ATTACHE
BERN, SWITZERLAND
 INSPECTOR FLETCHER D. THOMPSON
 8/12 - 16/71

NATIONAL SECURITY INFORMATION

SUMMARY

Unauthorized Disclosure
Subject to Criminal Sanctions

Official: Henry D. Grush, Legal Attache (Legat) since 12/5/62. Last inspection: 4/14 - 18/70.

Physical Condition and Maintenance - Excellent (Last Inspection - Very Good).
 Office located on fourth floor of Embassy Building in city limits of Bern. Marine Guards on duty in building lobby after working hours and periodic security checks made of our space. Office is well maintained, attractive and secure. Additional contiguous space approved to accommodate new communications equipment. No Bureau cars assigned.

REC-136

67-581753-1-44
 Classified by 6283
 Exempt from GDS, Category 3
 Declassification Indefinite

Investigative Operations - Very Good (Last Inspection - Very Good). Office covers Switzerland and Liechtenstein. Austria previously handled but taken over by Bonn Office 2/71. Active case load 7/31/71, 78, down from 99 last inspection, but average over 12-month period comparable with other offices and above previous 12-month period; delinquency below average 11 of 12 months. Number of cases originating in Bern Office and number of cases closed showed decline. Inspector instructed Legat to make certain all available cases are received and that cases are promptly handled and closed. Accomplishments for past year include 7 fugitive and/or Selective Service delinquents located, 4 deportations, and nearly \$300,000 in recoveries. Twenty Security Index subjects known to have visited or resided in Switzerland since last inspection; 15 other security subjects known to be residing in territory. High volume of work in Bern Office is of criminal nature involving large amounts of money deposited in Swiss banks. Treaty of mutual legal aid between United States and Switzerland is under active consideration and, if enacted, will give us same right of access to funds in banks as enjoyed by Swiss Police. (Will still have to show funds are necessary to prove crime). Embassy officials optimistic that treaty will be signed in near future. Legat instructed to follow closely. Inspector issued specific and positive series of steps which Legat is to

- Enclosure *sent 8-31-71*
- 1 - Mr. Callahan (Attention Mr. H. N. Bassett) (Sent Separately)
 - 1 - Mr. Brennan (Attention Foreign Liaison Desk) (Sent Separately)
 - 1 - Personnel File Henry D. Grush

SECRET CONTINUED - OVER

274-10128

Memorandum to Mr. Tolson

Re: Inspection - Office of Legal Attache, Bern SECRET

take in effort to develop additional information concerning activities of Black Panther Party (BPP) in Switzerland and to gain access to data concerning accounts in Swiss banks used for funding BPP.

While five high-level intelligence items submitted by Bern have been disseminated to White House, Legat instructed to devote more time and penetrative attention to this important program; Legat has positive attitude toward program. He is of opinion large majority of accomplishments, whether in criminal, security or intelligence field, would not have been possible without presence of Legat. No substantive errors detected.

Administrative Operations - Excellent (Last Inspection - Very Good). Office staffed by experienced Legat and one clerk-stenographer; well administered. Chief Clerk's Office operating efficiently; form errors below average and down from last inspection. Stenographic production substantially above average with retypes low. Continued close attention to all administrative operations stressed.

Personnel Matters - Excellent (Last Inspection - Excellent). Complement of one Agent and one clerk-stenographer (same as last inspection) considered adequate to handle liaison and other responsibilities. Legat agrees. Agent not overweight, unavailable or on limited duty. Close professional working relationship between Agent and clerk-stenographer; morale appears high.

Contacts - Very Good (Last Inspection - Excellent). Legat has congenial and productive liaison with wide range of agencies and individuals, both American and foreign. Instructions issued to strengthen liaison to insure Legat is promptly notified concerning proposed visits to U. S. by high Swiss officials in order that any courtesies which might be appropriate in furtherance of Bureau's best interests can be arranged (Legat was not promptly advised of plans of Swiss Attorney General to visit U. S. and Bureau headquarters). All persons met by Inspector expressed high regard for and confidence in Director, FBI and our personnel in Bern.

RECOMMENDATIONS

1. Henry D. Grush, GS-17 at \$34,716, aged 56, veteran, not on probation, Legal Attache since 12/5/62. Is reserved, businesslike and dependable. Most knowledgeable concerning Swiss government, laws and people. Grush is linguist capable of handling several languages. Qualified to continue as Legal Attache. Attached is letter advising Legat of inspection findings.

SECRET

Memorandum to Mr. Tolson
Re: Inspection - Office of Legal Attache, Bern

SECRET

2. The Bern Office covers Switzerland, which is a stable and conservative country. It may not offer the same potential for high-level intelligence as do some other territories, but positive items have been developed and should continue. Swiss banks have long been recognized as the repository for funds illegally acquired by Americans, now including some of the Black Panthers. We have made some progress in gaining access to these funds and findings of Inspector (together with prospects for signing mutual legal aid treaty between Switzerland and U. S.) indicate further success through close personal liaison is possible and probable. The existing case load, combined with these other considerations, justifies continuance of our Legat in Bern. It is, therefore, recommended that the office of the Legal Attache in Bern be continued with the present complement of one Agent and one clerk-stenographer.

V 7 JRW P

OK.
h

UNITED STATES GOVERNMENT

Memorandum

SECRET

- Tolson _____
- Belmont _____
- Mohr _____
- Bishop _____
- Brennan, C.D. _____
- Callahan _____
- Casper _____
- Conrad _____
- Dalbey _____
- Gale _____
- Ponder _____
- Rosen _____
- Tavel _____
- Walters _____
- Soyars _____
- Telo. Room _____
- Holmes _____
- Gandy _____

MR. TOLSON

DATE: September 7, 1971

J. K. PONDER

SUBJECT: INSPECTION - OFFICE OF LEGAL ATTACHE
BONN, GERMANY

INSPECTOR FLETCHER D. THOMPSON
8/17 - 22/71

NATIONAL SECURITY INFORMATION

Unauthorized Disclosure
Subject to Criminal Sanctions

SUMMARY

Officials: George A. Van Noy, Legal Attache (Legat) since 9/19/55. Floyd R. Peters, Assistant Legat since 6/28/70 and Number One Man since 2/19/71. (John C. F. Morris, Assistant Legat 12/29/62 - 7/31/71). Last inspection: 4/20 - 27/70.

Physical Condition and Maintenance - Very Good (Last Inspection - Very Good). Space on sixth floor of American Embassy Building in suburb of Bonn. Office is secure with Marine Guards on duty in building lobby after working hours and periodic security checks made of our space. Office is neat, well arranged and maintained, but extremely crowded. Legat instructed to pursue negotiations with Embassy officials for additional space, contiguous to existing space if possible, but office may have to move to another floor in same building. Legat to furnish estimates and recommendations to Bureau before making any commitments. No Bureau cars assigned.

Investigative Operations - Very Good (Last Inspection Excellent). West Germany, the Netherlands and Austria (since 12/70) covered by Bonn Office. Active case load (majority of security nature) 328 as of 7/31/71 (248 last inspection). Over 12-month period case load and cases closed per Agent well above average each month; delinquency below average each month.

SENSITIVE SOURCE AND SENSITIVE METHOD

, continues to produce valuable material, including information on Left Wing organizations in U. S. and travel of Security Index subjects and communists to Eastern Bloc.

SENSITIVE SOURCE AND METHOD

) Since April, 1971, necessary to transmit some items to Bureau in bulk without benefit of thorough analysis in Bonn Office.

Enclosure 9-8-71

- 1 - Mr. Callahan (Attention Mr. H. N. Bassett) (Sent Separately)
- 1 - Mr. Brennan (Attention Foreign Liaison Desk) (Sent Separately)
- 1 - Personnel Files George A. Van Noy and Floyd R. Peters

110-1111/102
 Date of Declassification Indefinite
 3

FDT:bhg (6)

CONTINUED - OVER SECRET

274-10/28

SECRET

Memorandum to Mr. Tolson

Re: Inspection - Office of Legal Attache, Bonn

determined experienced clerical employee (Miss Cuddy) capable of reviewing and processing much of this material. Assignment of this clerk-stenographer full time to project would release Agent personnel to handle other important responsibilities, primarily in the field of gathering high-level intelligence (HILEV). Since last inspection 78 Security Index subjects known to have visited or resided in Bonn territory; 76 other security subjects known to be residing these countries. Sources providing coverage on activities. In criminal field Bonn reported location of 22 fugitives and/or Selective Service delinquents in last 12 months. Valuable information also developed in several car theft ring cases, major thefts in U. S. and activities in Black Panther movement in Algeria. While 7 HILEV items worthy of dissemination to the White House (3 in August) have been submitted, there is a definite need for expansion and intensification. Positive program for this purpose outlined. Legat of definite opinion great majority accomplishments in all areas achieved only because of presence our personnel and would not have been possible through normal diplomatic channels. No substantive errors detected.

Administrative Operations - Excellent (Last Inspection - Excellent). Office is capably administered. Chief Clerk's Office operating efficiently and work current. Stenographic production above average even though time spent on clerical duties is high. Continued close attention to all administrative functions stressed.

Personnel Matters - Very Good (Last Inspection - Very Good). Personnel complement 3 Agents and 4 clerk-stenographers (2 Agents and 3 clerk-stenographers last inspection). Thorough analysis by Inspector of work load, types of cases, and experience of personnel determined Agents required to spend too much time in office handling high volume of security matters (SENSITIVE SOURCE Overtime essential, productive and equitably shared. Time in office higher than should be due to above- SENSITIVE METHOD . Morale appears high. Language ability Agent personnel satisfactory.

Contacts - Excellent (Last Inspection - Excellent). Productive and cordial liaison maintained with diversified contacts, both American and foreign, throughout territory. Legat recognizes need for cultivating and expanding contacts, especially in HILEV field. Instructed to do so. All contacts expressed highest regard for and confidence in Director and our Bonn personnel.

RECOMMENDATIONS

1. George A. Van Noy, GS-16 at \$33,757, aged 57, nonveteran, not on probation. Legat since 9/19/55; fully available. Makes excellent personal appearance;

Memorandum to Mr. Tolson
Re: Inspection - Office of Legal Attache, Bonn **SECRET**

quiet, but engaging personality; effective Bureau representative; highly respected by associates and others with whom he has contact. Fully qualified to continue as Legat. If approved, attached letter to Van Noy will summarize inspection findings.

JWP

2. Floyd R. Peters, GS-15 at \$25,059, aged 54, veteran, not on probation, Assistant Legat since 6/28/70, Number One Man since 2/19/71. Peters is a dedicated, hard-working Agent who is capably discharging his responsibilities. Qualified to continue as Assistant Legat and for further administrative advancement commensurate with needs of Bureau; fully available.

JWP

3. The Bonn Office handles a high volume of cases in security, criminal, liaison, intelligence and related areas. Legat feels, and inspection confirms, that great majority of accomplishments achieved only because of presence of our personnel on the scene. It is recommended, therefore, that office of Legal Attache, Bonn, be continued.

OK
A
LET
7
PM
JWP

UNITED STATES GOVERNMENT

Memorandum

SECRET

Tolson	_____
Felt	_____
Sullivan	_____
Mohr	_____
Bishop	_____
Brennan	_____
Callahan	_____
Casper	_____
Conrad	_____
Felt	_____
Gale	_____
Ponder	_____
Rosen	_____
Tavel	_____
Walters	_____
Soyars	_____
Tele. Room	_____
Holmes	_____
Gandy	_____

DJD
John

Ponder
W. J. ...

TO : MR. TOLSON

DATE: August 12, 1971

FROM : J. K. PONDER

JKA
INSPECTION

SUBJECT: INSPECTION - OFFICE OF LEGAL ATTACHE (LEGAT) -
BUENOS AIRES, ARGENTINA
INSPECTOR ARNOLD C. LARSON
7/29 - 8/3/71

NATIONAL SECURITY INFORMATION
Unauthorized Disclosure
SUMMARY Subject to Criminal Sanctions

Officials: John J. Wachter, Legal Attache since 3/22/67; Warren C. de Brueys, Assistant Legal Attache since 12/19/70 and Number One Man since 2/4/71. Last Inspection: 12/7 - 11/70.

Physical Condition and Maintenance - Very Good (Last Inspection - Very Good). Office located fourth floor, U. S. Embassy, downtown Buenos Aires. Space secure and attractively maintained. Additional space acquired since last inspection to accommodate additional personnel. No security violations. Need for security stressed. Bureau car well maintained - no safety defects. Operating and repair costs above averages; arrival of new car expected shortly which should reduce costs. Economy stressed. Minor housekeeping delinquencies detected ordered corrected.

Investigative Operations - Very Good (Last Inspection - Excellent). Office covers Argentina, Brazil, Uruguay, and Paraguay and is responsible for developing intelligence information regarding Marxist regime in neighboring Chile. 2 Agents added since last inspection to handle added territory and expanded coverage. Case load 7/31/71, 280 (277 active), up from 95 last inspection. Delinquency and case closings low. Increased case turnover encouraged. High percentage (73%) of cases generated by Legat personnel. 63% of case load is security matters. No substantive errors detected. Suggestion made to aid in espionage matter. 14 fugitives and Selective Service delinquents located, 3 deportations effected (down from last inspection), recoveries total \$5,165,350 (up substantially). Confidential sources and official contacts rated excellent and efforts being continued for further expansion of intelligence sources. 48 high-level intelligence (HILEV) items submitted, of which 22 furnished to White House. Estimated 90% of accomplishments would not have been achieved in absence of FBI representatives.

Administrative Operations - Excellent (Last Inspection Very Good) Chief Clerk's Office functioning smoothly and efficiently with low project work and pending work.

Enclosure

- 1 - Mr. Callahan (Attention Mr. H. N. Bassett) (Sent Separately)
- 1 - Mr. Brennan (Attention Foreign Liaison Desk) (Sent Separately)
- 1 - Personnel Files John J. Wachter and Warren C. de Brueys

67-38-1-4-1-38

Classified by 6283
Exempted by GDS, Category 3
Date of Declassification Indefinite

PO
3/1/72

274-10128

Memorandum to Mr. Tolson
Re: Inspection - Office of Legal Attache
Buenos Aires, Argentina

SECRET

File destruction current. Form errors and misfiled index cards below averages. Stenographic pool has high production, no delinquency or retyped pages. Confidential fund properly maintained. Travel, contact and per diem expenses up, but consistent with expanded coverage and increased personnel.

Personnel Matters - Excellent (Last Inspection - Excellent). Personnel complement of 3 Agents and 3 clerk-stenographers (up from one Agent and one clerk-stenographer last inspection due to expanded coverage and added territory) adequate but not excessive. All Agents proficient in necessary foreign languages. Overtime high but necessary, productive and equitably shared. Morale high.

Contacts - Excellent (Last Inspection - Excellent). Quality contacts developed in highest executive and operational levels of intelligence and law enforcement groups in territory. Aggressive program for expanded coverage is continuing and high utilization achieved. All persons contacted by Inspector expressed admiration and high esteem for Director, FBI and Buenos Aires personnel.

RECOMMENDATIONS

1. That office continue due to extent of territory, unrest and potential thereof affecting U. S., plus activities of great interest to White House, statistical accomplishments and further potential.

2. John J. Wachter, GS-16 at \$29,067, aged 53, nonveteran, not on probation, Legal Attache since 3/22/67. Wachter makes excellent personal appearance, is conscientious, hard-working Agent and excellent administrator. He is highly effective and aggressive in his liaison responsibilities and has a substantial grasp of the Bureau's overall operations. Considered highly qualified to continue in present assignment and to have excellent potential for additional responsibilities. Available for transfer or promotion.

- 2 -

CONTINUED - OVER

SECRET

Memorandum to Mr. Tolson
Re: Inspection - Office of Legal Attache
Buenos Aires, Argentina

SECRET

3. Warren C. de Brueys, GS-15 at \$25,059, aged 50, veteran, not on probation, Assistant Legal Attache at Buenos Aires since 12/19/70. Mr. de Brueys makes an excellent personal appearance, is conscientious, hard working and aggressive. He meets people well and has developed a number of contacts valuable to the Bureau. He has an excellent knowledge of the Bureau's work and is considered highly qualified to continue in his present position. He is interested in and completely available for any assignment.

JAD

4. Attached for approval is a letter advising the Legal Attache of the inspection findings.

JAD

JAD

JAD

*LT
PST
7*

JAM

SEE ADDENDUM -- NEXT PAGE

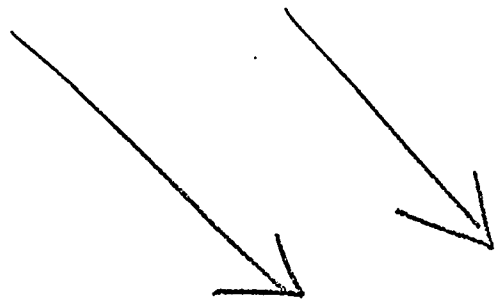

SECRET

SECRET

Memorandum to Mr. Tolson, from Mr. Ponder, 8/12/71
Re: Inspection - Office of Legal Attache
Buenos Aires, Argentina

ADDENDUM (WCS:csh), 8/13/71:

The conclusion to continue this office, without any qualification, is one with which I cannot agree. As I have previously indicated, I think the office should be kept open until the present Ambassador leaves, and then it should be considered as one that could be closed, with no damage done to this country. After all, no damage was done to the country before the office was ever opened.

This could be said about all our foreign offices. H

The inspection report points out that 90% of the accomplishments would not have been achieved in the absence of FBI representatives. How much of the 90% done by FBI representatives was absolutely necessary to the well-being of this country?

I think quite substantially. H

To repeat, I cannot agree with the conclusion to continue this office.

W. ~~WCS~~ SULLIVAN

I do not concur. H

ADDENDUM OF W. M. FELT/crt 8-16-71

As with the others, the overall question of continuance or expansion of Foreign Offices will be presented in one memorandum when all the inspections are completed.

OK. I approve continuation of Buenos Aires, Argentina office. H

*PSS
7*

SECRET

UNITED STATES GOVERNMENT

Memorandum

SECRET

- Tolson _____
- Felt _____
- Sullivan _____
- Mohr _____
- Bishop _____
- Brennan, P.D. _____
- Callahan _____
- Casper _____
- Conrad _____
- Malloy _____
- Malone _____
- Parsons _____
- Rosen _____
- Tavel _____
- Walters _____
- Soyars _____
- Tele. Room _____
- Holmes _____
- Gandy _____

TO : MR. TOLSON

DATE: August 26, 1971

FROM : J. K. PONDER

Caracas Inspected

SUBJECT: INSPECTION - OFFICE OF LEGAL ATTACHE
CARACAS, VENEZUELA
INSPECTOR ARNOLD C. LARSON NATIONAL SECURITY INFORMATION
8/9 - 12/71

Unauthorized Disclosure
Subject to Criminal Sanctions

SUMMARY

Officials: Joseph S. Leo, Legal Attache (Legat) since 12/14/70; Gordon F. Ellison, Assistant Legat since 12/23/70 and Number One Man since 5/18/71. First inspection since office opened 12/14/70.

Physical Condition and Maintenance - Very Good. Office temporarily located third floor, U. S. Embassy, commercial section of Caracas. Space secure, well organized and neatly maintained. Office to move to four rooms on sixth floor of U. S. Embassy in September, 1971. No security violations since office opened. Need for security stressed. No Bureau cars - Agents authorized to use personally owned. No accidents. Minor housekeeping delinquencies detected, ordered corrected.

Investigative Operations - Very Good. Office covers Venezuela, Colombia, Ecuador, Guyana, French Guiana, Netherlands Antilles, Surinam, Trinidad and Tobago. Case load 7/31/71, 98; (all active) up from 33 - 1/31/71, end of first full month of operation. No delinquency and case closings low. Increased case turnover encouraged. High percentage (65.3%) of cases generated by Legat personnel. 32.6% of case load criminal cases, 19.3% security matters. Statistical accomplishments - favorable; 12 fugitives and 3 Selective Service Act delinquents located, 1 deportation effected and recoveries total \$11,970. 25 high-level intelligence (HILEV) submissions made, of which 12 disseminated to White House. Instructed to increase coverage outside Venezuela and to broaden and increase intelligence coverage especially in HILEV Program. Organization of territory realigned to accomplish this. Estimated about 85% of accomplishments would not have been achieved in absence of FBI representatives. No substantive errors detected.

Administrative Operations - Very Good. Chief Clerk's Office functioning smoothly and efficiently with no project work and low pending work. File destruction current.

Enclosure sent 8-26-71

- 1 - Mr. Callahan (Attention Mr. H. N. Bassett) (Sent Separately)
- 1 - Mr. Brennan (Attention Foreign Liaison Desk) (Sent Separately)
- 1 - Personnel Files Joseph S. Leo and Gordon F. Ellison

ACL:bhg (6)

CONTINUED - OVER
SECRET

383719-5
3 SEP 13 1971
Classified by 6283
Exempt from automatic
downgrading and
declassification
indefinite

274-10128

#

Memorandum to Mr. Tolson
Re: Inspection - Office of Legal Attache, Caracas

SECRET

Form errors and misfiled index cards below averages. Clerk-stenographers have high production; no delinquency or retyped pages. Confidential Fund in balance and properly maintained. Travel, contact and per diem expenses consistent with efficient, productive operation. Suggestion made for strengthening accountability for items disseminated. Format used in letters to outside agencies corrected.

Personnel Matters - Excellent. Two Agents (adequate) assigned have vast territory to cover and source coverage must be increased in certain areas to successfully carry out mission, especially development of HILEV intelligence material. Realignment of territory made to improve coverage. Complement of two clerk-stenographers adequate, but not excessive. Agents proficient in Spanish language. Overtime high but necessary, productive and equitably shared. Morale high.

Contacts - Excellent. Quality contacts developed in highest executive and operating levels of intelligence and law enforcement agencies in territory. Aggressive program for expanded coverage is continuing. All persons contacted by Inspector expressed admiration and esteem for Director, FBI and Caracas personnel.

RECOMMENDATIONS

1. That Legat Office Caracas, operating only since December, 1970, be continued because of accomplishments already realized in HILEV intelligence program, potential for further HILEV development, and for other potential accomplishments which should improve as operation becomes better established.

concur.
A

RM

2. Joseph S. Leo, GS-15 at \$27,483, aged 43, nonveteran, not on probation and Legat at Caracas since 12/14/70. Leo makes excellent personal appearance, is conscientious, hard-working Agent and excellent administrator. He is highly effective and aggressive in his liaison responsibilities and has a substantial grasp of the Bureau's overall operations. Considered highly qualified to continue in present assignment. Attached for approval is a letter advising Legat of inspection findings.

RM



- 2 - CONTINUED - OVER
SECRET

SECRET

Memorandum to Mr. Tolson
Re: Inspection - Office of Legal Attache, Caracas

3. Gordon F. Ellison, GS-14 at \$20,815, aged 42, nonveteran, not on probation, Assistant Legat at Caracas since 12/23/70 and Number One Man since 5/8/71. Ellison makes a neat appearance, has a pleasant personality and is a conscientious, hard-working Agent. Ellison has made a real contribution to the effectiveness of the office and is considered qualified to continue in his present position.

OK ✓ ~~7~~ JPM Pm

SECRET

UNITED STATES GOVERNMENT

Memorandum

Tolson	_____
Felt	_____
Sullivan	_____
Mohr	_____
Bishop	_____
Brennan, C.D.	_____
Callahan	_____
Casper	_____
Conrad	_____
DeLoach	_____
Malone	_____
Rosen	_____
Tavel	_____
Walters	_____
Soyars	_____
Tele. Room	_____
Holmes	_____
Gandy	_____

TO : MR. TOLSON

DATE: August 27, 1971

SECRET

FROM : J. K. PONDER

SUBJECT: INSPECTION OFFICE OF LEGAL ATTACHE
 HONG KONG, BRITISH CROWN COLONY
 INSPECTOR MASON G. WORKING
 8/7 - 13/71

NATIONAL SECURITY INFORMATION
 Unauthorized Disclosure
 Subject to Criminal Sanctions

SUMMARY

Officials: Daniel A. Grove, Legal Liaison Officer since 4/17/66. Joseph D. Maurice, Assistant Legal Liaison Officer since 12/15/70. Last inspection: 11/23 - 29/70.

Physical Condition and Maintenance - Excellent (Last Inspection - Excellent). Office located on second floor, American Consulate General, downtown Hong Kong. Space modern, attractively maintained and businesslike in appearance. Minor renovation of space contemplated upon receipt of new crypto equipment. Security of space and documents stressed. No security violations and no Bureau automobiles assigned.

Investigative Operations - Very Good (Last Inspection - Very Good). Office covers Hong Kong, Australia, Malaysia, New Zealand, Philippines, Singapore, South Vietnam and Thailand. Active case load 7/31/71 - 195, down from 214 last inspection (10/31/70). Case load and case closings per Agent exceed other Legat averages and delinquency below Legat averages 8 out of 9 months since last inspection. No substantive errors detected in 285 files reviewed. Investigative matters being closely followed by Legat through established contacts and sources: 64% of case load security; 23% criminal; 13% applicant and other. Hong Kong Communist Party, dominated and controlled by Chinese Communists (CHICOM), continues to gain strength and has established numerous front organizations which propagandize CHICOM political line throughout Kong Kong. Revolutionary tactics and guerrilla activities directed by CHICOMS continuing in Philippines, Malaysia and Thailand. Matters regarding Chinese aliens and Chinese seamen who desert ships in U. S. carefully analyzed and existing programs receiving close investigative attention. Programs have potential for identifying individuals involved in CHICOM intelligence activity; however, material from resulting investigations in U. S. not available to Legat. One Security Index subject residing in territory. 5 Security Index subjects and 15 security subjects have visited countries covered by Legat since last inspection.

Enclosures *sent 8-30-71*

- 1 - Mr. Callahan (Attention Mr. H. N. Bassett) (Sent Separately)
- 1 - Mr. Brennan (Attention Foreign Liaison Desk) (Sent Separately)
- 1 - Personnel Files Daniel A. Grove and Joseph D. Maurice

Classified by *[Signature]*
 Exempt from GDS
 Date of Classification Indefinite
33/800

274-10128

Memorandum to Mr. Tolson
Re: Inspection - Office of Legal Attache
Hong Kong

SECRET

42 subjects of Bureau security cases residing in territory. Legat's coverage of Security Index subjects and subjects of security cases effective and Bureau's interests being protected. 52 fugitives and Selective Service delinquents located in territory over past Fiscal Year (50 for previous Fiscal Year). 8 informal deportations effected.

Since inception of high-level intelligence (HILEV) program (9/70), Legat has submitted 15 items to Bureau, only 5 of which have been disseminated to White House. Participation significantly below average of other Legats. Lack of attention to this program highlighted by Inspector and instructions issued to vigorously pursue and develop high-level intelligence sources and contacts. Legat reminded of President's contemplated travel to Peking and instructed to maintain close contact with all individuals in a position to furnish advance information concerning plans of subversive elements and organizations to foment demonstrations in opposition to President's visit.

Administrative Operations - Fair (Last Inspection - Very Good). Chief Clerk's Office well organized, with slight backlog in project and pending work. Misfiled index cards are below average. Form errors slightly above field average, with substantial reduction over previous inspection. Stenographic production high with no delinquency. Voluntary overtime essential, productive and being equitably shared.

HILEV Program not being afforded desired prompt, penetrative, aggressive and imaginative investigative and administrative attention. Administrative write-up prepared pointing out weaknesses in investigative and administrative handling of this program (copy attached). Legat Grove instructed to fully comply with Bureau instructions intensifying the development of high-level intelligence sources and contacts so vitally needed, thus enabling the Bureau to fulfill its obligations. Deficiencies detected in Legat Grove's handling of HILEV Program necessitate downgrading of administrative operations to Fair.

Personnel Matters - Excellent (Last Inspection - Excellent). Complement of 2 Agents and 2 clerk-stenographers (same as last inspection). Legat requested one additional Agent and one additional clerk based on assigned case load, vastness of territory covered and additional responsibilities. Work load, road trips, and overall responsibilities closely analyzed by Inspector justifying only present complement of 2 Agents and 2 clerks - Legat agreed. Training procedures effective. No Agents overweight, unavailable or on limited duty. Morale appears high.

Contacts - Very Good (Last Inspection - Excellent). Effective sources and contacts exist at all levels of police and security organizations, insuring investigative responsibilities being properly handled. 45 new sources developed since previous inspection.

SECRET 2 - CONTINUED - OVER

Memorandum to Mr. Tolson
Re: Inspection - Office of Legal Attache ~~SECRET~~
Hong Kong

84 National Academy graduates occupy responsible positions throughout territory covered. Two additional candidates presently attending National Academy session. Sources and contacts so urgently required in connection with HILEV Program need further attention. Persons contacted by Inspector spoke highly of the Director, FBI and Hong Kong personnel.

RECOMMENDATIONS

1. Daniel A. Grove, GS-16 at \$29,067, aged 41, veteran, not on probation, Legal Liaison Officer, Hong Kong, since 4/17/66. He makes an excellent personal appearance, is intelligent and has been most effective in establishing liaison contacts who can assist the FBI in handling normal investigative matters. He has an excellent command of the Chinese - Mandarin language. Since the previous inspection Legat Grove has failed to fully comply with Bureau instructions in aggressively obtaining intelligence data vitally needed under the HILEV Program (Administrative write-up attached). His failure to develop sources and contacts capable of producing high-level intelligence data as urgently needed, and his marginal administration of this important program warrant administrative action. Therefore, it is recommended that he be retained as Legat but censured and placed on probation. If approved, letter attached.

letter not sent. letter of charges sent in lieu of 9/1/71 En

Yes

Q

No ann. w. scheduled 9/31

2. Joseph D. Maurice, GS-14 at \$23,591, aged 45, veteran, not on probation, Assistant Legal Liaison Officer, Hong Kong, since 12/15/70. Maurice has an excellent personality and presents a most businesslike appearance. He is mature, intelligent and since being assigned to Hong Kong is gaining the necessary experience to handle assigned duties. He is considered qualified to continue in present assignment.

Q

3. During the current inspection all pending investigative matters and the overall operation of Legat, Hong Kong, were subjected to penetrative and in-depth analysis. Investigative phases of Legat operations are being afforded aggressive attention; however, noticeable weaknesses detected in the developing of intelligence sources relating to HILEV Program. Hong Kong is the closest Legat operation to

SECRET - 3 - CONTINUED - OVER

Memorandum to Mr. Tolson
Re: Inspection - Office of Legal Attache
Hong Kong

SECRET

Communist China and Hong Kong itself thrives with CHICOM activity. An extremely high potential exists for the development of intelligence data so vitally needed to fulfill our obligations concerning the internal security of the United States and our additional responsibility to the President. It is essential that our office in Hong Kong be retained since it has produced some high-level intelligence data of interest to us and, due to its strategic location, has the potential of obtaining highly sensitive information which would otherwise not be available.

Handwritten signature

✓

OK.
J

PERMANENT BRIEF OF DANIEL A. GROVE ATTACHED.

- 4 -

SECRET

UNITED STATES GOVERNMENT

Memorandum

- Tolson _____
- Felt _____
- Sullivan _____
- Mohr _____
- Bishop _____
- Brennan, C.D. _____
- Callahan _____
- Casper _____
- Conrad _____
- DeLoach _____
- Gale _____
- Rosen _____
- Tavel _____
- Walters _____
- Soyars _____
- Telo. Room _____
- Holmes _____
- Gandy _____

chys
Walters
Daly
5-Bunney

TO : MR. TOLSON

SECRET

DATE: August 25, 1971

FROM : J. K. PONDER *P*

SUBJECT: INSPECTION - OFFICE OF LEGAL ATTACHE

LA PAZ, BOLIVIA

INSPECTOR ARNOLD C. LARSON

8/4 - 7/71

NATIONAL SECURITY INFORMATION

Unauthorized Disclosure
Subject to Criminal Sanctions

SUMMARY

Official: Nick F. Stames, Legal Attache (Legat), arrived La Paz 12/22/70, and opened office. First inspection.

Physical Condition and Maintenance - Very Good. Office temporarily located on third floor, U. S. Embassy, in downtown La Paz. To move to fourth floor about 10/1/71 and occupy two rooms with vault. Current space secure, well organized and attractively maintained. No security violations since office opened. Need for security stressed. No Bureau car - Legat authorized to utilize personally owned vehicle. No accidents. Minor housekeeping delinquencies detected, ordered corrected.

Investigative Operations - Very Good. Office covers Bolivia and Peru. Case load 7/31/71, 46, below average. Delinquency zero and case closings low. Increased case turnover encouraged. High percentage (69.6%) of cases generated by Legat. 72% of case load is of security nature. No substantive errors detected. One fugitive and 3 Selective Service Act delinquents located. No deportations effected. Recoveries total \$9,759.00. One applicant recruited. Criminal and intelligence source programs rated very good. Efforts being made for further expansion of high-level intelligence (HILEV) sources. 24 HILEV items submitted, of which 14 were disseminated to White House. Legat feels none of the accomplishments would have been achieved without FBI representative on scene.

Administrative Operations - Excellent. Chief Clerk's Office functioning smoothly and efficiently with no project work and low pending work. Form errors and misfiled index cards below averages. Clerk-stenographer has high-production, no delinquency or retyped pages. Confidential fund in balance and properly maintained. Travel, contact and per diem expenses consistent with sound operations.

Enclosure

1 - Mr. Callahan (Attention Mr. H. N. Bassett) (Sent Separately)

1 - Mr. Brennan (Attention Foreign Liaison Desk) (Sent Separately)

1 - Personnel File Nick F. Stames

ACL:bhg (6)

SECRET

CONTINUED

Classified by 6283
Exempt from GDS, Category 1, 3
Date of Declassification Indefinite

274-10/28

Memorandum to Mr. Tolson
Re: Inspection - Office of Legal Attache
La Paz, Bolivia

SECRET

Personnel Matters - Excellent. Personnel complement of one Agent and one clerk-stenographer, adequate but not excessive. Agent proficient in necessary language. Overtime high but necessary and productive. Morale high.

Contacts - Excellent. Quality contacts developed in high executive and operational levels of intelligence and law enforcement agencies. Legat encouraged to continue aggressive program for expanded coverage. All persons contacted by Inspector expressed admiration and high esteem for the Director, FBI and La Paz personnel.

RECOMMENDATIONS

1. It is recommended that this office be continued in view of the territory covered, the unrest and potential for strife affecting the U. S. and the production of HILEV intelligence material.

I concur.
H

Pm

2. Nick F. Stames, GS-15, at \$25,867, aged 36, nonveteran, not on probation, Legal Attache at La Paz since 12/22/70. Stames makes an excellent personal appearance; is conscientious, hard working, and an aggressive administrator. He is highly effective liaison representative and has excellent grasp of Bureau's overall operations. He previously served as ASAC in San Juan and is considered well qualified to continue in his present assignment or for a position of greater responsibility.

Just prior to the inspection Stames advised the Bureau of a threat against the life of a student attending college in the U. S. by airtel rather than cable, causing a delay in notifying authorities responsible for her protection. Stames is considered culpable and censure is recommended. (LETTER WILL HANDLE)

Attached for approval is a letter advising Legal Attache Stames of the inspection findings and censuring him for his dereliction in the above matter.

OK ✓
H

7 *JMN* *Pm*

SECRET

UNITED STATES GOVERNMENT

Memorandum

Tolson _____
 Felt _____
 Sullivan _____
 Mohr _____
 Bishop _____
 Brennan, C.D. _____
 Callahan _____
 Casper _____
 Conrad _____
 Dalbey _____
 Gale _____
 Ponder _____
 Rosen _____
 Tavel _____
 Walters _____
 Soyars _____
 Tele. Room _____
 Holmes _____
 Gandy _____

TO : MR. TOLSON

SECRET

DATE: August 23, 1971

FROM : J. K. PONDERT *JKP*

SUBJECT: *Inspection*
INSPECTION - OFFICE OF LEGAL ATTACHE (LEGAT)
LONDON, ENGLAND

INSPECTOR FLETCHER D. THOMPSON NATIONAL SECURITY INFORMATION
7/29 - 8/4/71
Unauthorized Disclosure
Subject to Criminal Sanctions

SUMMARY

Officials: John T. Minnich, Legat since 10/6/65; Alden C. McCray, Assistant Legat since 11/22/58 and Number One Man since 11/4/66. Last inspection: 12/10 - 17/70.

Physical Condition and Maintenance - Excellent (Last Inspection - Excellent). Office conveniently located American Embassy Building, second floor, downtown London. Marine Guards on duty after working hours and make periodic around-the-clock security checks. Cleaning handled by Embassy personnel in presence of Bureau personnel. Space attractive, well maintained and secure. No Bureau cars assigned.

Investigative Operations - Very Good (Last Inspection - Excellent). Office covers Great Britain and Ireland. Case load temporarily declined when new Copenhagen Office took over Scandinavian countries December, 1970. Since March, 1971, case load has been substantially higher than period 6 months earlier and on 7/31/71 was 341 (293 last inspection). Average cases per Agent consistently above other Legats during last 12 months. Delinquency above average most months while cases closed generally comparable other offices. 137 persons who were Bureau fugitives or Selective Service delinquents located (down from last inspection); 3 deportations effected. Legat of opinion majority of accomplishments would not have been realized without presence of Legat Office. Vital need for developing high-level intelligence (HILEV) information strongly emphasized by Inspector. Importance of program recognized by London personnel and 19 HILEV items submitted of which 11 disseminated to White House. Legat of opinion additional information of value can be developed if additional Agent assigned to office. Inspector agreed (handled separately). No substantive errors detected.

Administrative Operations - Excellent (Last Inspection - Excellent). Office staffed with experienced personnel and effectively administered. Chief Clerk's Office neat

Enclosure

- 1 - Mr. Callahan (Attention Mr. H. N. Bassett) (Sent Separately)
- 1 - Mr. Brennan (Attention Foreign Liaison Desk) (Sent Separately)
- 1 - Personnel Files John T. Minnich and Alden C. McCray

FDT:bhg (6)

SECRET

CONTINUED - OVER

OCT 5 1971

REC-144 67-3430-21-100
 Searched _____
 Number of _____
 Date of _____
 Category _____
 Declassification Indefinite
 33/100
 10
 5

274-10/28

200

2

6

Memorandum to Mr. Tolson
Re: Inspection - Office of Legal Attache
London, England

SECRET

and efficiently operated; work is current. Stenographic production well above average. Continued close attention to all administrative operations stressed.

Personnel Matters - Very Good (Last Inspection - Very Good). Personnel complement of 2 Agents and 3 clerk-stenographers same as last inspection. Thorough analysis by Inspector of work load and potential for further development of HILEV sources indicates one additional Agent appears justified (handled separately); clerical complement adequate. Overtime high but essential, productive and equitably shared. No Agents unavailable, overweight or on limited duty. Morale appears high.

Contacts - Excellent (Last Inspection - Excellent). Aggressive and effective liaison program with wide range of foreign and U. S. Government agencies and individuals. Contacts are diversified and productive. All who were met by Inspector expressed highest regard for Director, FBI and London personnel.

RECOMMENDATIONS

1. John T. Minnich, GS-17 at \$34,716, aged 52, veteran, not on probation, Legat since 10/6/65. Makes excellent impression; is strong, experienced and dedicated Bureau representative and highly respected by persons with whom he does business. Fully qualified to continue as Legat. Available for promotion or transfer. Attached for approval is letter to Minnich advising him of inspection findings.

P
lm

2. Alden C. McCray, GS-15 at \$27,483, aged 47, veteran, not on probation, Assistant Legat since 11/22/58 and Number One Man since 11/4/66. McCray is a dedicated, respected, hard-working Agent who is capably discharging his responsibilities and qualified to continue in present assignment and for further administrative advancement.

P
lm

3. Heavy case load of investigative matters as well as important liaison and intelligence responsibilities in territory covered by London justifies continuance of Legat Office there. Recommendations regarding Legat's request for additional Agent will be submitted in overall memorandum of inspection results of Legal Attaches.

P
lm

✓
JH

7

SECRET

UNITED STATES GOVERNMENT

Memorandum

- Tolson _____
- Felt _____
- Sullivan _____
- Mohr _____
- Bishop _____
- Greenway _____
- Callahan _____
- Casper _____
- Conrad _____
- Dalbey _____
- Gale _____
- Rosen _____
- Tavel _____
- Walters _____
- Soyars _____
- Tele. Room _____
- Holmes _____
- Gandy _____

Handwritten signatures and initials:
 \$
 [Signature]
 [Signature]
 [Signature]
 [Signature]
 [Signature]

TO : MR. TOLSON

DATE: August 25, 1971

FROM : J. K. PONDER

SECRET

SUBJECT: INSPECTION - OFFICE OF LEGAL ATTACHE
 MADRID, SPAIN
 INSPECTOR PAUL J. MOHR
 7/29 - 8/3/71

NATIONAL SECURITY INFORMATION
 Unauthorized Disclosure
 Subject to Criminal Sanctions

SUMMARY

Official: Vadja V. Kolombatovic, Legal Attache (Legat) since 7/28/69, when office reopened.

Physical Condition and Maintenance - Excellent (Last Inspection - Excellent). Office on third floor of Embassy building, which is conveniently located. Space is efficiently organized, attractive and excellently maintained. Additional space, previously approved, being acquired in which to locate coding equipment. Strict attention afforded security of office and adherence to regulations.

Investigative Operations - Very Good (Last Inspection - Very Good). Office covers Spain, Gibraltar, Morocco and Portugal. Active case load 7/31/71 - 116 (last inspection 120). Case load above average for all Legat offices. Delinquency consistently below average; case closings above average. 25 Bureau subjects (11 fugitives and 14 Selective Service violators) located; one deportation effected; Legat instrumental in causing recovery in New York City of El Greco painting valued at over \$1 million and considered a Spanish National Treasure. 26 high-level intelligence (HILEV) items submitted to Bureau, of which 17 furnished to White House. Instructed to give major emphasis to HILEV Program. No substantive errors detected. Legat strongly expanding police sources to achieve maximum results.

Administrative Operations - Excellent (Last Inspection - Excellent). Chief Clerk's Office efficiently organized and functioning smoothly. Form errors and misfiled index cards low. Pending and project work current. Stenographic production high; retypes low. Confidential fund closely controlled.

Personnel Matters - Excellent (Last Inspection - Excellent). Complement of one Agent and one clerk-stenographer adequate. Legat available, not overweight, on probation or limited duty. Overtime essential and productive. Morale excellent.

Enclosure sent 8-26-71

- 1 - Mr. Callahan (Attention Mr. H. N. Bassett) (Sent Separately)
- 1 - Mr. Brennan (Attention Foreign Liaison Desk) (Sent Separately)
- 1 - Personnel File Vadja V. Kolombatovic

Classified by 6783
 Date of Declassification Indefinite
 110-884/wc
 [Handwritten initials and marks]

274-10128

Memorandum to Mr. Tolson
Re: Inspection - Office of Legal Attache
Madrid, Spain

SECRET

Contacts - Excellent (Last Inspection - Very Good). Legat has developed and expanded wide variety of sources at all levels in police and security agencies in Spain, Morocco and Portugal and extremely cooperative contacts in U. S. Government agencies. Legat currently contacting extremely valuable sources in HILEV Program; Robert C. Hill, Ambassador to Spain, extremely laudatory of Director and FBI. Ambassador expressed appreciation for presence of FBI and Legat's rapport with Embassy personnel. Other officials contacted expressed high esteem for Director, FBI and Madrid personnel.

RECOMMENDATIONS

1. Vadja V. Kolombatovic, GS-15 at \$25,867, aged 47, veteran, not on probation. Legat Attache at Madrid since 7/28/69. Makes an excellent, mature appearance with engaging personality. Dedicated, hard working and has great deal of initiative. Especially well suited for position of Legat. Able administrator and has excellent knowledge of duties. Fluent in several foreign languages and is considered fully qualified to continue as Legat. Attached for approval is letter summarizing inspection findings.

Pm

2. In view of excellent results achieved in 2 years since it was reopened, it is recommended that this Legat be continued.

I concur.
H

7 — *Am*

Pm

SECRET

UNITED STATES GOVERNMENT

SECRET

Memorandum

- Tolson _____
- Felt _____
- Sullivan _____
- Mohr _____
- Bishop _____
- Brennan, C.D. _____
- Callahan _____
- Casper _____
- Conrad _____
- Dalbey _____
- Gale _____
- Ponder _____
- Rosen _____
- Tavel _____
- Walters _____
- Soyars _____
- Tele. Room _____
- Holmes _____
- Gandy _____

TO : MR. TOLSON ✓

DATE: August 11, 1971

FROM : J. K. PONDER *JKP*

SUBJECT: INSPECTION - OFFICE OF LEGAL ATTACHE (LEGAT)
 MANAGUA, NICARAGUA *INSPECTION*
 INSPECTOR ARNOLD C. LARSON NATIONAL SECURITY INFORMATION
 7/24 - 28/71

Unauthorized Disclosure
 Subject to Criminal Sanctions
Ph

Ponder

Officials: James A. Miller, Legal Attache since 12/27/70; Armand A. Cammarota, Assistant Legal Attache and Number One Man since 1/9/71. First inspection since office opened December, 1970.

Physical Condition and Maintenance - Very Good. Office temporarily but conveniently located in two-story apartment building within U. S. Embassy grounds. Expect to move into main Embassy Building in future. Instructed to press for new space. Space adequate, efficiently organized and well maintained. Security stressed and suggestions for improvement made. No Bureau cars assigned and Agent personnel authorized to use personally owned. No accidents.

Investigative Operations - Fair. Office covers all of Central America. Case load 6/30/71, 68 (65 active). Case load and case closings low; no delinquency. Statistical accomplishments to 7/1/71 favorable - 20 fugitives and Selective Service delinquents located; 5 deportations effected; 10 stolen vehicles located, recovery value \$56,812.92. Contributions of high-level intelligence (HILEV) material disappointing (13 HILEV submissions, 4 used). One Security Index subject in territory; none visited area. Instructed to broaden criminal and security coverage and intensify efforts to obtain HILEV information. One substantive error detected for delayed investigation and Legal Attache subject of Administrative Memorandum for inadequate handling of liaison contacts. Percentage of substantive errors above average.

Administrative Operations - Fair. Chief Clerk's Office well organized and functioning efficiently. Form errors above field average and misfiled index cards below average. No project work and pending work below field average. Stenographic production and accuracy high, no retypes or delinquency. Recommendations made for strengthening administrative control of confidential fund. Overtime productive and equitably shared. Travel and per diem expenses being held to a minimum. Legat improperly recording sources and contacts with sources; material relating to two possible sources filed in office administration file; and suggested source not indexed or properly recorded.

Enclosures

- 1 - Mr. Callahan (Attention Mr. H. N. Bassett) (Sent Separately)
- 1 - Mr. Brennan (Attention Foreign Liaison Unit) (Sent Separately)
- 1 - Personnel Files James A. Miller and Armand A. Cammarota

Classified by 6283
 Exempt from GDS, Category 3
 Date of Declassification Indefinite

SECRET

274-10138

Memorandum to Mr. Tolson
Re: Inspection - Office of Legal Attache
Managua, Nicaragua

SECRET

Personnel Matters - Very Good. Staff of two Agents and two clerk-stenographers adequate but not excessive. No Agents on limited duty, on probation, overweight or unavailable. Morale appears high.

Contacts - Very Good. Several quality contacts developed in high executive and operational levels of intelligence and law enforcement agencies in territory. Intensification ordered. Ambassador and others contacted by Inspector expressed admiration and esteem for Director, FBI and personnel in Managua.

RECOMMENDATIONS

1./ That Legat be continued in view of extent of territory (all of Central America); unrest, particularly in Guatemala; the Communist interest throughout territory, particularly in Guatemala and Costra Rica; internal strife between El Salvadore and Honduras; and potential unrest affecting internal security of the United States; statistical accomplishments (20 fugitives and Selective Service delinquents located, 5 deportations effected, 10 stolen vehicles recovered valued at \$56, 812.92); and potential for additional accomplishments. Office in existence seven months and potential not yet developed.

2. James A. Miller, GS-15 at \$25,059, aged 46, veteran, not on probation, Legal Attache at Managua since 12/27/70. He makes an excellent, mature appearance and seems interested and enthusiastic. He was involved in a substantive error write-up and an administrative write-up (copies attached). Error related to excessive delay (12/14/70 to 6/7/71) in verifying address in Nicaragua of Selective Service subject. Miller explained the delay was due to opening of new office and case not received at Managua until 3/2/71; that he initiated action 3/3/71 but made no record of it. Explanation unacceptable. Miller was assigned case in Mexico City, 12/14/70, and sent to Managua by Mexico City 1/21/71. Records at Mexico City reflect serials received Managua 1/25/71. File shows no action taken by Miller until 5/4/71. Subject's address in Managua verified 6/7/71.

The administrative write-up dealt with lack of sources (Miller had 27 of the 103 in office records); contacts with sources not recorded; contacts with sources

- 2 - CONTINUED - OVER

SECRET

Memorandum to Mr. Tolson
Re: Inspection - Office of Legal Attache
Managua, Nicaragua

SECRET

indicated on #3 (locator) card as relating to office administration; failure to contact possible source in Panama suggested by New Orleans; and failure to index, properly record or pursue another possible source, an American Businessman in Panama. Material relating to latter sources improperly placed in file on office administration.

Miller explained he has other sources but maintains no record of them in the Legat; he utilized the office administration file number to sign out on when making contacts; he made no entries for contacts after hours; and information concerning possible sources was mistakenly directed to office administration file.

This is Miller's first assignment as Legat -- his previous duties related primarily to a road trip out of Mexico City. He needs additional time to develop ability to administer and direct Legat operations. In view of the deficiencies detected, recommend Miller be censured and placed on probation. Letter attached for approval will summarize inspection results and advise him of censure and probation.

3. Armand A. Cammarota, GS-14 at \$26,367, aged 54, veteran, not on probation, Assistant Legat since 1/9/71. Cammarota makes an excellent, mature appearance; has leadership qualities; is dedicated, experienced and knowledgeable employee, with sincere, businesslike and enthusiastic attitude. Legat considers him qualified for additional responsibilities and recommends him for immediate advancement. Inspector concurs that he is qualified for position of greater responsibility.

ADDENDUM OF W. M. FELT/crt 8-11-71

Recommend recheck inspection at the end of 120 days.

DISCUSSED WITH MR. FELT 11-3-71. HE SAID
RECHECK NOT NECESSARY SINCE LEGAT
MILLER WAS
LATER REMOVED.

- 3 -

SECRET

UNITED STATES GOVERNMENT

Memorandum

Tolson	_____
Felt	_____
Sullivan	_____
Mohr	_____
Bishop	_____
Brennan, C.D.	_____
Callahan	_____
Casper	_____
Conrad	_____
Dalbey	_____
Gale	_____
Ponder	_____
Rosen	_____
Tavel	_____
Walters	_____
Soyars	_____
Tele. Room	_____
Holmes	_____
Gandy	_____

TO : MR. TOLSON

DATE: August 9, 1971

SECRET

FROM : J. K. PONDER *JKP*

Bassett

SUBJECT: INSPECTION - OFFICE OF LEGAL ATTACHE
MEXICO CITY, ~~INSPECTION~~
INSPECTOR ARNOLD C. LARSON
7/12 - 23/71

P
Larson
INSPECTION

NATIONAL SECURITY INFORMATION
Unauthorized Disclosure

SUMMARY Subject to Criminal Sanctions

Officials: Robert T. Nischwitz, Legal Attache since 4/27/70; John J. Foarde, Jr., Assistant Legal Attache and Number One Man since 4/20/66. Last inspection: 6/27 - 7/15/70.

Physical Condition and Maintenance - Very Good (Last Inspection - Very Good). Office conveniently located fourth floor U. S. Embassy in downtown Mexico City. Office space for headquarters and two Resident Agencies secure, well organized and neatly maintained. No security violations since last inspection and no security weaknesses noted. Minor housekeeping delinquencies ordered corrected. Four automobiles inspected -- no safety defects. Two new cars on order, one to be sold. Fleet of five automobiles is adequate, fully utilized and securely maintained. Automobile operating and repair costs reduced, but remain above field averages - economy stressed. No accidents since last inspection.

Investigative Operations - Very Good (Last Inspection - Very Good). Mexico City is only operational foreign office and encompasses all of Mexico. Case load -- 627 (603 active); up from last inspection when office also covered Central America - 616 (553 active). Average delinquency since last inspection below other Legal Attache Offices (Legats) and field. Case load and case closings per Agent below other Legats -- instructions given to improve. Statistical accomplishments down past 12 months compared with previous twelve months' period in Selective Service Act delinquents and fugitives located, deportations and total monetary recoveries; but up in automobiles recovered and their value. This decline due in part to loss of Central America in December, 1970, when Managua Legat opened. Improvement ordered. Extensive and productive security informant network covers all areas of Bureau interest; however, there has been decline numerical strength. Instructions given to broaden coverage and exploit logical contacts to develop high-level intelligence information.

Enclosure

- 1 - Mr. Callahan (Attention Mr. H. N. Bassett) (Sent Separately)
- 1 - Mr. Brennan (Attention Foreign Liaison Unit) (Sent Separately)
- 1 - Personnel Files Robert T. Nischwitz and John J. Foarde, Jr.

REC-136

67-583676-1-158

SEARCHED 2 INDEXED 3
SEP 20 1971

ACL:bhg (6)

Classified by 6283
Excluded from GDS, Category 3
Date of Declassification Indefinite

CONTINUED -
SECRET

SEP 21 1971

274-10128

SECRET

Criminal informant strength improved since last inspection - further improvement ordered. Substantial contributions made by office in securing high-level intelligence of interest to Bureau and White House. Particularly significant information developed regarding recent student demonstrations in Mexico, Soviet and North Korean training of Mexican guerillas and matters involving Mexico - Cuba relations. This phase of operation emphasized by Inspector. No substantive errors detected.

Administrative Operations - Very Good (Last Inspection - Very Good). Supervision equitably shared between Legat and Assistant Legat. Chief Clerk's Office well organized and functioning efficiently. Pending work and project work above average - attributable to new Bureau-authorized file destruction program. Intensification of destruction ordered. Form errors below average. Misfiled index cards average for offices of similar size and below overall field average. Stenographic production above field average; no retypes or delinquencies. Travel and communications expenses reduced; slight increase in per diem costs -- justified. Confidential Fund closely controlled. Recommendation made for strengthening accounting procedures with respect to informant payments. Overtime essential, productive and equitably shared. Trend memoranda prepared calling for better protection of informant identity in communications and destruction of informant memoranda no longer needed.

Personnel Matters - Very Good (Last Inspection - Very Good). Personnel complement 7/12/71, 23 (11 Agents, including Legat and Assistant Legat; 12 clerks). Inspector considers clerical complement excessive by one stenographer; Legat agrees. Reduction ordered by attrition. Agent complement reduced by one since last inspection due to opening new Legat in Managua, Nicaragua. Territory covered by Mexico City reduced correspondingly. Agent complement adequate, but not excessive. No Agents on limited duty, probation, overweight or unavailable. No training weaknesses noted. Personnel represent U. S. Government in efficient and effective manner. Morale appears very high.

Contacts - Excellent (Last Inspection - Excellent). The two FBI National Academy (NA) graduates who occupied positions of importance in agencies within Legat territory were replaced with administration change in Mexico in December, 1970. Mexican authorities encouraged to nominate qualified police officers for NA to upgrade law enforcement. Excellent network of contacts maintained on operational and executive levels of Mexican Government and police agencies. Contacts among U. S. agencies indicate effective relationships. All officials contacted by Inspector hold Director, FBI and Legat personnel in extremely high esteem.

RECOMMENDATIONS

1. Robert T. Nischwitz, GS-16 at \$29,067, aged 47, veteran, not on probation, Legal Attache at Mexico City since 4/27/70, second office as Legat. Nischwitz makes an excellent, mature appearance. He possesses effective leadership qualities; is a

SECRET

Memorandum to Mr. Tolson
Re: Inspection - Office of Legal Attache

SECRET

dedicated, knowledgeable administrator, and exhibits a sincere, businesslike and enthusiastic attitude in current assignment. Completely qualified to continue as Legal Attache. Attached for approval is letter summarizing inspection findings.

JHP

2. John J. Foarde, Jr., GS-15 at \$26,675, aged 47, veteran, not on probation, Assistant Legal Attache and Number One Man at Mexico City since 4/20/66. Unavailable during inspection due to serious illness (hepatitis). Legat advised he makes a mature, businesslike appearance and has pleasant personality. Considered conscientious, hard working, and a capable administrator. Legat rates him excellent, noting he has served in current assignment five years, demonstrating effective leadership and ability. Results of inspection tend to substantiate these comments. Recommend Foarde continue in his present position.

JHP

3. Recommendations concerning other personnel handled separately.

v

JHP

~~JHP~~

UNITED STATES GOVERNMENT

Memorandum

- Tolson _____
- Felt _____
- Sullivan _____
- Mohr _____
- Bishop _____
- Brennan, C.D.
- Callahan _____
- Casper _____
- Conrad _____
- Dalbey _____
- Gale _____
- Ponder _____
- Rosen _____
- Tavel _____
- Walters _____
- Soyars _____
- Tele. Room _____
- Holmes _____
- Gandy _____

TO : MR. TOLSON

DATE: August 24, 1971

SECRET

FROM : J. K. PONDER

Ottawa, Ontario Inspection

SUBJECT: INSPECTION - OFFICE OF LEGAL ATTACHE
OTTAWA, CANADA
INSPECTOR THOMAS W. LEAVITT
8/3 - 6/71:

NATIONAL SECURITY INFORMATION
Unauthorized Disclosure
SUMMARY Subject to Criminal Sanctions

Officials: Moss Lee Innes, Legal Attache (Legat) since 4/19/59; Joseph A. Marion, Jr., Assistant Legat since 4/20/70. Last inspection: 11/23 - 27/70.

Physical Condition and Maintenance - Very Good (Last Inspection - Very Good). Office located on 4th floor, U. S. Embassy Building, in downtown Ottawa. Space crowded but secure and well maintained. No security violations. Legat instructed to follow closely installation of auxiliary power supply which has been ordered.

Investigative Operations - Excellent (Last Inspection - Excellent). Legat, Ottawa, nonoperational. Case load as of 7/31/71 594 (570 active); last inspection 599 (590 active). Active case load averaged 600 per month since last inspection; up from average of 572 for comparable period prior to previous inspection. Delinquency high - basically due to number of priority matters handled by Royal Canadian Mounted Police (RCMP). Instructed to follow proper posting procedures to assist in reducing delinquency. Slight increase in cases closed per month (314) over last inspection (298). Statistical accomplishments up in fugitives located; automobile and monetary recoveries down. Increase in deportations. Selective Service delinquent locates up considerably (654) since last inspection (499). No significant change in Communist Party (CP) membership; however, CP of Canada is supporting U. S.-based revolutionary group, the "Black Revolutionary Party." 43 Security Index subjects residing in Canada - an increase of 7 in a year. Activity of New Left and Black Power advocates continues unabated. Instructed to aggressively pursue matter of New Left fugitives with RCMP. Chinese Communist (Chicom) Embassy established with potential for intelligence activity. Increase in number U. S. residents visiting Chicom Embassy. Legat instructed to closely follow and keep Bureau advised. 21 high-level intelligence (HILEV) items submitted, of which 9 furnished to White House. Instructed to place special emphasis on HILEV program. No substantive errors detected.

Enclosure

- 1 - Mr. Callahan (Attention Mr. H. N. Bassett) (Sent Separately)
- 1 - Mr. Brennan (Attention Foreign Liaison Desk) (Sent Separately)
- 1 - Personnel Files Moss Lee Innes and Joseph A. Marion, Jr.

SECRET CONTINUED - OVER

mod

REC-100 FOR 308251-1-803

Berapfen

Dw. 571

10-3-71

Classified by 6083

Exempted by GDS Category 3

Date of Declassification Indefinite

274-10128

Memorandum to Mr. Tolson
Re: Inspection - Office of Legal Attache
Ottawa, Canada

SECRET

Administrative Operations - Very Good (Last Inspection - Very Good). Form errors above field average. Weaknesses ordered corrected. Misfiled index cards below field average. Suggestions made regarding preparation and destruction of index cards to alleviate space problem. Trend detected in failure of clerical personnel to initial incoming and outgoing mail - ordered corrected. Communications, travel, per diem and contact costs down. Economy stressed.

Personnel Matters - Very Good (Last Inspection - Very Good). Personnel complement 2 Agents, 4 clerk-stenographers - increase of one clerk-stenographer since last inspection. Staff adequate, but not excessive. Morale high, overtime productive.

Contacts - Excellent (Last Inspection - Excellent). Relationship with RCMP excellent. Quality liaison contacts maintained on all levels. All officials contacted expressed high regard for FBI and Legat personnel.

RECOMMENDATIONS

1. Recommended that Legat Office, Ottawa, be retained. The relationship between U. S. and Canada brought about by common border, similar domestic problems and constant travel between countries of dangerous New Left and black extremists requires daily contact with liaison sources regarding these problems. Potential for Chinese communist intelligence activity directed against U. S. from Canada is also paramount. Existence of Legat, Ottawa, is also beneficial in location of various types of fugitives of interest to us as well as monetary recoveries.

2. Moss Lee Innes, aged 50, GS-16 at \$31,881, veteran, not on probation, at Ottawa since 4/19/59. Presents impressive personal appearance, is mature and extremely able liaison representative. Qualified to continue as Legat. Attached for approval is letter summarizing inspection findings.

- 2 -

CONTINUED - OVER

SECRET

Memorandum to Mr. Tolson
Re: Inspection - Office of Legal Attache
Ottawa, Canada

SECRET

3. Joseph A. Marion, Jr., aged 44, GS-15 at \$24,251, veteran, not on probation, at Ottawa since 4/20/70. Marion is mature, businesslike individual who is functioning effectively in current capacity. Qualified to continue as Assistant Legat.

V. 7 *AM* *me*

SECRET

UNITED STATES GOVERNMENT

Memorandum

Tolson	_____
Felt	_____
Sullivan	_____
Mohr	_____
Bishop	_____
Brennan, C.D.	_____
Callahan	_____
Casper	_____
Conrad	_____
Dalbey	_____
Gale	_____
Ponder	_____
Rosen	_____
Tavel	_____
Walters	_____
Soyars	_____
Telo. Room	_____
Holmes	_____
Gandy	_____

TO : MR. TOLSON ✓

DATE: August 25, 1971

SECRET

FROM : J. K. PONDER

Paris Inspection

SUBJECT: INSPECTION - OFFICE OF LEGAL ATTACHE
PARIS, FRANCE
INSPECTOR FLETCHER D. THOMPSON
8/5 - 11/71

NATIONAL SECURITY INFORMATION

Unauthorized Disclosure

Subject to Criminal Sanctions

SUMMARY

Officials: Norman W. Philcox, Legal Attache (Legat) since 7/8/60. Mike G. Zinck Assistant Legat since 12/22/70 and Number One Man since 8/20/71. Last inspection: 12/2 - 9/70.

Physical Condition and Maintenance - Very Good (Last Inspection - Very Good). Office conveniently located downtown Paris on 6th floor of American Embassy Annex. May be moved at request of Embassy to 4th floor. Legat has taken initiative to insure suitable space obtained if move materializes. Space tentatively committed will afford comparable or improved security, larger vault and additional needed working space. Legat instructed to follow closely. Marine Guards on duty in building lobby after working hours and periodic security checks made of our space. Office is well maintained and secure. No Bureau cars assigned.

Investigative Operations - Excellent (Last Inspection - Excellent). France, Belgium, Luxembourg, Liberia and Sierra Leone covered by Paris Office. Third Agent assigned December, 1970, for primary purpose of affording greater attention to high-level intelligence (HILEV) matters. Active case load 7/31/71 - 209, down slightly from last inspection, but case load and closings have been up substantially past 6 months; delinquency below average each of last 12 months. 76 Security Index subjects known to have visited countries covered by Paris since last inspection; 45 security subjects not on Security Index known to reside in territory. Legat kept advised of activity these persons through American and foreign sources. Accomplishments during past year include 27 fugitives and/or Selective Service delinquents located, and recovery of \$7,000,000 in securities stolen in United States. Legat of opinion majority of these accomplishments possible only because Legat present and could not have been achieved through normal diplomatic channels. Legat has cordial and productive liaison with police and security forces in territory. Necessity for caution by all personnel in dealing with foreign nationals stressed by Inspector

Enclosure

- 1 - Mr. Callahan (Attention Mr. H. N. Basset) (Sent Separately)
- 1 - Mr. Brennan (Attention Foreign Liaison Desk) (Sent Separately)
- 1 - Personnel Files Norman W. Philcox and Mike G. Zinck

67-400571-1-95

Classified 10
Exempt 10
Date of Declassification Indefinite

3

FDT:bhg (6) 98 SECRET CONTINUED - OVER

274-10128

Memorandum to Mr. Tolson
Re: Inspection - Office of Legal Attache
Paris, France

SECRET

since they are charged with responsibility for gathering positive intelligence information even from friendly nations, and our employees on foreign assignment could be possible targets. Noting probability Chinese communists will be admitted to United Nations and, therefore, have Mission in New York in near future, Legat instructed to be especially alert for information of value concerning modus operandi of Chinese Communist Intelligence Service (CHICOM) from experience of French security forces since diplomatic relations have existed between France and CHICOMS for extended period. Considerable support in France of Eldridge Cleaver faction of Black Panther Party; effective coverage through French criminal and security services. Favorable results achieved in recent months in acquiring HILEV data of interest to President - 38 HILEV items submitted; 21 disseminated to White House (10 to White House in June - July). High priority this important program strongly emphasized by Inspector to all personnel. Legat recognizes importance and has positive plans for expansion of sources. No substantive errors detected.

Administrative Operations - Excellent (Last Inspection - Excellent). Legat and clerical staff are well experienced in foreign operations and office is effectively administered. Inspector suggested in interest of closer supervision and fixing of responsibility that Legat prepare written instructions setting forth guidelines for division of work between him and the two assistants. Legat agreed and this has been done. Minor corrections ordered in Defense Plans. Chief Clerk's Office operating efficiently; work current and form errors below average. Stenographic production high with retypes low. Continued close attention to all administrative operations stressed.

Personnel Matters - Very Good (Last Inspection - Very Good). Personnel complement of 3 Agents and 3 clerk-stenographers considered optimum number for handling liaison and other responsibilities. Overtime essential, productive and equitably shared. No Agents unavailable, overweight or on limited duty. Staff working as team and morale appears high.

Contacts - Excellent (Last Inspection - Excellent). Effective liaison maintained with diversified and productive contacts, both American and foreign. All met by Inspector were cordial and expressed high regard for and confidence in Director, FBI, and Paris personnel.

RECOMMENDATIONS

1. Norman W. Philcox, GS-17 at \$36,000, aged 56, nonveteran, not on probation, Legat since 6/18/59. Experienced, businesslike, highly respected by

- 2 - CONTINUED - OVER

SECRET

Memorandum to Mr. Tolson
Re: Inspection - Office of Legal Attache
Paris, France

SECRET

persons with whom he does business, effective Bureau representative and able administrator; fully qualified to continue as Legat. Attached for approval is letter to Philcox advising him of inspection findings.

P
m

2. Mike G. Zinck, GS-14 at \$22,897, aged 41, veteran, not on probation, Assistant Legat since 12/22/70 and Number One Man since 8/20/71. Zinck makes excellent initial impression, is personable, experienced in foreign operations, hard worker and qualified to continue as Assistant Legat.

P
m

3. The case load of investigative matters, as well as the important liaison and intelligence responsibilities in the countries covered by Paris, justifies continuance of our Legal Attache Office there. It is recommended, therefore, that the office of Legal Attache in Paris be continued with the present complement of 3 Agents and 3 clerk-stenographers.

✓ 7 *JH* *P*
m

UNITED STATES GOVERNMENT

Memorandum

Tolson	_____
Felt	_____
Sullivan	_____
Mohr	_____
Bishop	_____
Belmont	_____
Callahan	_____
Casper	_____
Conrad	_____
Dalbey	_____
Gale	_____
W.P. Miller	_____
Rosen	_____
Tavel	_____
Walters	_____
Soyars	_____
Telo. Room	_____
Holmes	_____
Gandy	_____

TO : MR. TOLSON

DATE: August 31, 1971

SECRET

FROM : J. K. PONDER *Pm*

SUBJECT: INSPECTION - OFFICE OF LEGAL ATTACHE

ROME, ITALY

INSPECTOR PAUL J. MOHR

8/3 - 9/71

NATIONAL SECURITY INFORMATION

Unauthorized Disclosure

Subject to Criminal Sanctions

SUMMARY

Officials: Thomas J. Biamonte, Legal Attache (Legat) since 11/7/67. Joseph C. Michela, Assistant Legal Attache since 12/14/70. Last inspection: 4/6 - 13/70.

Physical Condition and Maintenance - Excellent (Last Inspection - Excellent).

Office is convenient to police and agency contacts from its location on the second floor of the American Embassy Building. No Bureau automobiles assigned. Space is efficiently organized and excellently maintained. Security regulations strictly adhered to.

Investigative Operations - Very Good (Last Inspection - Very Good). Office covers Italy, Greece, Turkey, and Cyprus. Turkey and Cyprus added to Rome territory during expansion of Legats in December, 1970. Active case load 7/31/71 was 169 (147 last inspection). Average cases assigned per Agent below that of other Legats during past six months. Cases closed slightly below average. Consistently low delinquency. 14 Selective Service delinquents and fugitives located; 1 deportation effected; and no recoveries. No substantive errors detected.

Since January, 1971, Rome has submitted ten high-level intelligence (HILEV) items for possible dissemination to the White House - seven used. Rome below average in submissions compared to other Legats, but higher percentage of items submitted have been disseminated. Legat and Assistant Legat instructed to intensify efforts to exceed HILEV performance this area. Inspector instructed that high-level contacts be developed and, starting immediately, Legats are to increase frequency and duration of road trips to Greece, Turkey, and Cyprus to implement objectives of HILEV Program.

Administrative Operations - Very Good (Last Inspection - Very Good). Chief Clerk's Office functioning efficiently and well organized. Form errors low, no

Enclosure *sent 8-1-71*

- 1 - Mr. Callahan (Attention Mr. H. N. Bassett) (Sent Separately)
- 1 - Mr. Brennan (Attention Foreign Liaison Desk) (Sent Separately)
- 1 - Personnel Files Thomas J. Biamonte and Joseph C. Michela

PJM:bhg (6) *AB* **SECRET** CONTINUED - OVER

Classified by *16 JWB/wor*
 Exempt from GDS, Category *3-850*
 Date of Declassification Indefinite *13*

274-10/28

Memorandum to Mr. Tolson
Re: Inspection - Office of Legal Attache, Rome

SECRET

missed index cards detected. Pending and project work current. Stenographic retypes low, production high. Confidential expenditures tightly controlled. Trend of improper handling of references and indexing names appearing in substantive files noted.

Personnel Matters - Very Good (Last Inspection - Very Good). Two Agents and two clerk-stenographers assigned - adequate. Rome Office reduced one man 4/21/70 as result of analysis of work load during last inspection. Assistant Legat Michela assigned to Rome Office during expansion of Legats in December, 1970. Continued assignment of Assistant Legat considered contingent upon ability to produce results in HILEV Program. Legat instructed to make appropriate recommendations regarding reduction of personnel if additional production not realized. Legat instructed to follow closely. No Agents on limited duty, probation, overweight, or unavailable. Overtime productive, essential, and equitably shared. Morale appears high.

Contacts - Excellent (Last Inspection - Excellent). Rome Office since last inspection expanded contacts and has effective sources in a broad area of foreign and U. S. Government agencies, as well as sources outside of official agencies. Recently developed sources should result in more effective HILEV Program. Officials contacted by Inspector complimentary concerning the Director, FBI and Rome Office personnel. Ambassador Graham Martin expressed high regard for Director and stated he relies heavily on FBI personnel in Rome and appreciates their efforts.

RECOMMENDATIONS

1. Thomas J. Biamonte, GS-16 at \$29,067.00, aged 44, veteran, not on probation, fully available, Legal Attache, Rome since 11/7/67. Makes excellent appearance, mature, engaging personality, well suited for liaison work in Italy. Is hard working, enthusiastic and fully qualified to continue in present assignment as Legat. Letter summarizing inspection findings is attached for approval. 

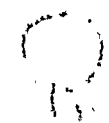
2. Joseph C. Michela, GS-15 at \$26,675.00, aged 46, veteran, not on probation, Assistant Legat since 12/14/70. Michela on annual leave during 

- 2 -

CONTINUED - OVER

SECRET

Memorandum to Mr. Tolson
Re: Inspection - Office of Legal Attache, Rome

SECRET

inspection. Inspector interviewed Michela just prior to departure. Michela previously Legat in Rome and should be continued in current assignment.

PM

3. In view of the case load and the political and economic importance of the countries covered by Rome and the potential to produce a large volume of high-level intelligence, it is recommended that the Rome Office be continued with its present complement.

PM

*OK.
H*

V. 7

PM

UNITED STATES GOVERNMENT

Memorandum

Handwritten initials: P, J, W

Tolson	_____
Felt	_____
Sullivan	_____
Mohr	_____
Bishop	_____
Brennan, C.D.	_____
Callahan	_____
Casper	_____
Conrad	_____
Dalbey	_____
Gale	_____
Pondor	_____
Rosen	_____
Tavel	_____
Walters	_____
Soyars	_____
Tele. Room	_____
Holmes	_____
Gandy	_____

TO : MR. TOLSON

SECRET DATE: September 8, 1971

FROM : J. K. PONDER *JKP*

SUBJECT: INSPECTION - OFFICE OF LEGAL ATTACHE

TEL AVIV, ISRAEL

INSPECTOR PAUL J. MOHR

8/16 - 20/71

NATIONAL SECURITY INFORMATION

Unauthorized Disclosure

Subject to Criminal Sanctions

SUMMARY

Officials: Theodore N. Goble, Legal Attache (Legat) since 12/20/70; Harold Rubenstein, Assistant Legat since 12/20/70. First inspection since office opened 12/20/70 as result of expansion of foreign offices.

Physical Condition and Maintenance - Fair. Office located in American Embassy Building convenient to downtown Tel Aviv. Temporary space well maintained and secure. Strict security measures in effect. (Subsequent to inspection, security breach by clerk-stenographer noted in a mailing procedure and called to Bureau's attention - handled separately. On this basis Legat being downgraded to Fair. Would otherwise have been Excellent.) Will occupy excellent permanent office space in near future. No Bureau cars assigned.

Investigative Operations - Excellent. Office covers only Israel. Case load 7/31/71 - 68, below average, but increasing steadily since office opened. Legat of opinion will continue as coverage expanded. Delinquency low. 8 Selective Service delinquents and Bureau fugitives located; 3 deportations effected; no recoveries. Highly successful in high-level intelligence (HILEV) results. Since January, 1971, 43 items submitted - 28 furnished to White House. Expansion of present coverage stressed. Legat of opinion additional high-level information can be obtained and will make efforts to expand coverage. No substantive errors detected.

Administrative Operations - Very Good. Experienced personnel assigned and office effectively administered. Chief Clerk's Office neat and operated satisfactorily. Work is current and stenographic production above average. Continued close attention to all administrative operations stressed. *697185-1-4*

Personnel Matters - Very Good. Two Agents and two clerk-stenographers assigned. Analysis of work load and the potential for further development of high-level contacts

Enclosure *sent 9-8-71*

- 1 - Mr. Callahan (Attention Mr. H. N. Bassett) (Sent Separately)
- 1 - Mr. Brennan (Attention Foreign Liaison Desk) (Sent Separately)
- 1 - Personnel Files Theodore N. Goble and Harold Rubenstein

Classification Indefinite
 6283
 3
THREE

PJM:bhg (6) CONTINUED - OVER

SECRET

Handwritten signature: JKP

274-10/28

Memorandum to Mr. Tolson

Re: Inspection - Office of Legal Attache, Tel Aviv **SECRET**

justify continuing present Agent and clerical complement. Overtime essential, productive and equitably shared. No Agents unavailable, overweight or on limited duty. Morale high.

Contacts - Excellent. Legat and Assistant Legat successful in gaining confidence of high Israeli government officials. Wide range of contacts, all productive, and diversified. All who were met by Inspector expressed high regard for the Director, FBI and Tel Aviv personnel.

RECOMMENDATIONS

1. Theodore N. Goble, GS-15 at \$25,059, aged 46, veteran, not on probation, Legat since 12/20/70. Is dedicated, hard working and enthusiastic. Makes excellent impression; effective in personal contacts, and is highly respected. Has good command of Hebrew language and is considered qualified to continue as Legat. He is available for promotion or transfer. Attached for approval is letter to Goble advising him of inspection findings.

JWD

2. Harold Rubenstein, GS-14 at \$22,897, aged 49, veteran, not on probation, Assistant Legat since 12/20/70. Dedicated, hard-working Agent who makes an excellent impression and is very effective in his contacts. Fully capable and qualified to continue in present assignment. Fluent in Hebrew, Spanish and French. Is available for promotion or transfer.

JWD

3. In view of highly successful results in obtaining items of high-level nature which have been disseminated to White House, it is recommended this office be continued.

OK.

Note Deputy Chief of Mission (DCM) Tel Aviv, denied use of cable facilities to Legat 8/20/71 and insisted on privilege of reviewing our material

Memorandum to Mr. Tolson

Re: Inspection - Office of Legal Attache, Tel Aviv **SECRET**

before authorizing transmission of same. We protested DCM actions to Secretary of State and advised Dr. Kissinger at the White House. By letter 9/2/71 Mr. Rogers advised that he had suspended above requirement placed on Legat by DCM. Attached letter instructs Legat to keep Bureau advised of all subsequent developments.

AM *L*
PER
7 *MM*

UNITED STATES GOVERNMENT

Memorandum

SECRET

MR. TOLSON

DATE: August 24, 1971

FROM : J. K. PONDER

- Tolson _____
- Belmont _____
- Sullivan _____
- Mohr _____
- Wick _____
- DeLoach _____
- Casper _____
- Conrad _____
- Malloy _____
- Rosen _____
- Tavel _____
- Walters _____
- Soyars _____
- Telo. Room _____
- Holmes _____
- Gandy _____

Bassett

Walters

DeLoach

SUBJECT: INSPECTION - OFFICE OF LEGAL ATTACHE
 TOKYO, JAPAN
 INSPECTOR MASON G. WORKING
 7/31 - 8/6/71

NATIONAL SECURITY INFORMATION
 Unauthorized Disclosure
 Subject to Criminal Sanctions

SUMMARY

Officials: Harold L. Child, Jr., Legal Attache (Legat) 11/14/54 to 12/4/67 and since 6/26/69. Roderick V. Prechtl, Jr., Assistant Legat 6/12/66 to 11/7/67; Legat 11/7/67 to 5/28/69. Assistant Legat since 5/28/69. Last inspection: 11/14 - 22/70.

Physical Condition and Maintenance - Very Good (Last Inspection - Very Good). Office located second floor, American Embassy Annex, fireproof reinforced concrete building, downtown Tokyo. Space adequate and, although old, is neat and businesslike in appearance. Contracts being obtained to refurbish which will modernize appearance. Security of space and documents stressed. No security violations. No Bureau automobiles assigned.

Investigative Operations - Excellent (Last Inspection - Very Good). Office covers Japan, Okinawa, Taiwan and South Korea. Active cases 307; steady growth in case load past year. Cases per Agent exceed other Legats and delinquency below Legat averages every month since last inspection. No substantive errors detected in 373 files reviewed. Cases being closely followed by Legat through established contacts and sources. 70% of case load security; 4% criminal; 26% applicant and other. Japan Communist Party (JCP), with estimated membership 250,000, has achieved increasing power in Japanese political positions -- considered major threat to internal security of Japan. Soviets continue to be major financial contributor to JCP. FUNDS contributed to aid in June, 1971, elections. Communist front organizations active, following doctrines of JCP, Communist China and USSR. Strength of radical New Left group increasing; anticipate violent protest against policies of Japanese Government and U. S. involvement in Vietnam war. Black extremist activities confined primarily to promoting unrest among black servicemen; no organized black extremist groups. Coverage of Security Index subjects and subjects of security cases very effective. Six Bureau fugitives and nine Selective

Enclosure

- 1 - Mr. Callahan (Attention Mr. H. N. Bassett) (Sent Separately)
- 1 - Mr. Brennan (Attention Foreign Liaison Desk) (Sent Separately)
- 1 - Personnel Files Harold L. Child, Jr. and Roderick V. Prechtl, Jr.

Classified by 6283
 Exempt from GDS Category 3
 Date of Declassification Indefinite

274-10128

SECRET

Memorandum to Mr. Tolson
Re: Inspection - Office of Legal Attache
Tokyo, Japan

Service delinquents located in 9-month period since last inspection (comparable to 9 and 14 in one-year period, last inspection). No recoveries this inspection or last. Since inception High Level Intelligence (HILEV) Program in September, 1970, 43 HILEV items submitted; 20 disseminated to White House. Legat affording aggressive and imaginative attention to HILEV Program. High-level sources and contacts furnishing valuable intelligence data -- instructed to develop additional sources and contacts of this caliber. Legat extremely knowledgeable of political, social, economic, and intelligence situation in territory covered.

Administrative Operations - Excellent (Last Inspection - Excellent). Chief Clerk's Office well organized and operating efficiently. Form errors and misfiled index cards well below field averages. Stenographic accuracy and production very high - no delinquency. Agent and clerical personnel operating at peak performance to handle intensified intelligence program.

Personnel Matters - Excellent (Last Inspection - Excellent). Complement of 2 Agents and 2 clerk-stenographers, same as last inspection. Present complement adequate, not excessive - Legat agrees. Agent and clerical overtime exceptionally high, but essential, productive and equitably shared. Clerical employees refuse to request compensatory leave or overtime pay although overtime necessary and essential to fulfill assigned duties. Training procedures effective. No Agents overweight, unavailable or on limited duty. Morale outstanding.

Contacts - Excellent (Last Inspection - Excellent). Quality high-level contacts maintained in strategic branches of police and security agencies in all countries covered. Program very effective. 71 contacts developed since last inspection. 9 National Academy (NA) graduates occupy responsible positions; 3 additional candidates in current NA session. All persons contacted during inspection spoke highly of Director, FBI and Tokyo personnel.

RECOMMENDATIONS

1. Harold L. Child, Jr., GS-17 at \$36,000, aged 51, nonveteran, not on probation. Legat Tokyo 11/14/54 to 12/4/67 and since 6/26/69. Makes excellent personal appearance and has excellent personality. Conscientious, aggressive, highly intelligent and capable administrator. Excellent command of Japanese language. Extremely well qualified to continue in present assignment or for further advancement. If approved, attached letter will advise him of inspection findings.

SECRET

P.m.

SECRET

Memorandum to Mr. Tolson
Re: Inspection - Office of Legal Attache
Tokyo, Japan

2. Roderick V. Precht, Jr., GS-15 at \$26,675, aged 45, veteran, not on probation. Assistant Legat, Tokyo, 6/12/66 to 11/7/67; Legat 11/7/67 to 5/28/69; and Assistant Legat since 5/28/69. Makes excellent personal appearance. Has mature, intelligent, and businesslike approach to all assignments and responsibilities. He is most personable, very enthusiastic, and loyal. Has capably demonstrated ability to handle Legat position in past and well qualified for administrative advancement. Retention in present position justified.

PM

3. During current inspection all pending investigative matters and overall operation of Legat, Tokyo, subjected to penetrative and in-depth analysis. All phases of Legat operation being afforded vigorous attention with particular emphasis on obtaining HILEV data. Presence of Legat has resulted in obtaining HILEV data disseminated to President and other Government agencies, which information would not be available without Bureau representative on scene. To fulfill our obligations concerning internal security of U. S. and particularly to the President, it is essential that Legat, Tokyo, be retained.

V7

PM

GR
H

- 3 - SECRET

Mr. Tolson _____

Mr. Felt _____

~~Mr. Sullivan~~ _____

~~Mr. Mohr~~ _____

Mr. Bishop _____

Mr. Miller, E.S. _____

~~Mr. Callahan~~ _____

Mr. Casper _____

Mr. Conrad _____

Mr. Dalbey _____

Mr. Cleveland _____

~~Mr. Ponder~~ _____

Mr. Rosen _____

Mr. Tavel _____

Mr. Walters _____

Mr. Soyars _____ *RV*

Tele. Room _____

Miss Holmes _____

Miss Gandy _____

~~_____~~

~~_____~~

UNITED STATES GOVERNMENT

Memorandum

SECRET

W.B.
JD/ha

- _____ Bishop
- _____ Brennan, C.D.
- _____ Callahan
- _____ Casper
- _____ Conrad
- _____ Dalbey
- _____ Gale
- _____ Ponder
- _____ Rosen
- _____ Tavel
- _____ Walters
- _____ Soyars
- _____ Tele. Room
- _____ Holmes
- _____ Gandy

TO : MR. TOLSON

Foreigns

DATE: September 14, 1971

FROM : J. K. PONDER

General

Revised
9/14/71

SUBJECT: FOREIGN OPERATIONS - LEGAL ATTACHE OFFICES (LEGAT)

PURPOSE: To summarize views of Bureau officials and set forth recommendations of Inspection Division relative to retention of 17 existing Legats, recommend opening of 6 more, and reopen Resident Agency in Mexico.

BACKGROUND: Prior to December, 1970, we operated 11 Legat Offices (Bern, Bonn, Buenos Aires, Hong Kong, London, Madrid, Mexico City, Ottawa, Paris, Rome and Tokyo). In September, 1970, the President in conversation with the Director requested that we expand our foreign operations because of the President's desire for better intelligence. The President also discussed this with the Secretary of State who advised that he thought it was a good idea. As a result, 6 additional offices were opened in the latter part of December, 1970 (Beirut, Caracas, Copenhagen, La Paz, Managua and Tel Aviv). These were opened based on the opinion of the President and Dr. Kissinger that our Legats were furnishing highly valuable information of interest to the White House.

W.B. Sullivan
JD/ha

On the basis of our productivity in obtaining high-level information, the President again requested (May, 1971) the Director to consider further foreign office expansion. In response to this, at Director's request Domestic Intelligence Division (DID) recommended reopening our offices in Manila, Rio de Janeiro and Santo Domingo and opening new offices at Canberra, Kuala Lumpur and New Delhi. DID also recommended adding one Agent to each of 5 existing offices - Beirut, Caracas, London, Madrid and Tokyo.

539244-381

Mr. Sullivan had approved of the 6 additional Legats opened in December, 1970, and, in fact, personally initiated the recommendation of one of them (Beirut). He had not previously expressed opposition to the expansion of our foreign liaison operations, but in a memorandum 6/7/71 Mr. Sullivan expressed the strong opinion that the proposed addition of Agent personnel abroad and reopening or opening of new offices should not be accomplished as he felt that many of our Legats were not furnishing information and services sufficiently valuable to justify their retention. In his memorandum 6/16/71 Mr. Sullivan recommended our offices at Bern, Buenos Aires, Hong Kong, Madrid and Tokyo should be closed. With regard to Beirut, Caracas, Copenhagen, La Paz, Managua and Tel Aviv (opened December, 1970, with his approval) Mr. Sullivan said he seriously doubted the value of these offices and recommended they

NATIONAL SECURITY INFORMATION
Messrs. Felt, Sullivan, Mohr, Callahan, Miller
JKP:wml (4)

Classified by 6283
Exempt from GDS, Category 3
Date of Declassification Indefinite

Unauthorized Disclosure
Subject to Criminal Sanctions

CONTINUED - OVER

SECRET

SECRET

274-10128

SECRET

Memo for Mr. Tolson
Re: Foreign Operations - Legats

be permitted to operate for 6 months and then analyzed thoroughly to determine if they were worth the money being spent; if not, all of them should be closed. He completely opposed further expansion and opening offices in Manila, Rio de Janeiro, Santo Domingo, Canberra, Kuala Lumpur and New Delhi.

INSPECTION DIVISION EVALUATION:

Based on the divergence of opinion the Director ordered immediate inspections of all existing Legats. These inspections have been completed and separate memoranda have gone forward justifying the retention of all 17 existing offices. Retention has been based primarily on our success in obtaining high-level items of interest to the White House. As of 8/31/71, 521 items had been submitted to the Bureau by these offices, of which 295 had been disseminated to the White House. Numerous favorable comments have been received from the White House. In each instance the Director concurred with recommendations that the 17 existing offices be continued.

It had been suggested by the DID that our coverage could be stepped up by increasing our complement in Beirut, Caracas, London, Madrid and Tokyo. As a result of our inspection an additional Agent was recommended for London and this was approved. It is also felt that the Resident Agency formerly at Hermosillo, Mexico, should be reopened to cover a vast region now handled as a road trip. This should be staffed by personnel already assigned to our Mexico City Office. Addition of personnel to other Legat Offices is not recommended.

As indicated, it was recommended that offices be opened in Canberra, Kuala Lumpur, Manila, New Delhi, Rio de Janeiro and Santo Domingo. Based on the desires of the White House for additional high-level intelligence and our past successes in this area, it is felt that we should advise the President that we are ready to go forward with this expansion, if that is still his desire, at any time he wishes. Reopening Manila would relieve Hong Kong of a long road trip and provide closer attention to mounting political developments in China. Reopening Rio de Janeiro would relieve Buenos Aires of a 25,000 mile road trip and provide on-the-spot coverage in this important area (Brazil) which is larger than the United States. Reopening Santo Domingo would relieve San Juan Office of road trip and furnish prompt coverage not only of Dominican Republic but of current political developments in Haiti. Canberra would cover Australia and New Zealand, relieving Hong Kong of the road trip. Kuala Lumpur would cover Thailand, Malaysia, Singapore, and initiate coverage in Indonesia, would relieve Hong Kong of road trip and provide more rapid coverage of area currently politically important. New Delhi would

SECRET

Memo for Mr. Tolson
Re: Foreign Operations - Legats

cover India, East and West Pakistan and Nepal, an area where we previously had no coverage, but where potential for political intelligence is high.

QUOTA OF FBI EMPLOYEES ON FOREIGN ASSIGNMENT:

Our quota of personnel on foreign assignment authorized by State Department is 88. When it was approved that we add 1 Agent to London, it was decided to move an Agent from Buenos Aires to London to stay within our quota. Subsequently, James A. Miller was removed as Legat at Managua, and it was recommended and approved that Managua operate with only 1 man until the full potential of that office could be determined. Thus we presently have 87 employees on foreign assignment, 1 under our quota. As we may have to replace Agent in Buenos Aires or Managua, we should not reduce our quota.

In its recommendation of 5/28/71 for expansion of Legat operations, DID recommended staffing the 6 proposed offices as follows:

	<u>Agents</u>	<u>Clerks</u>	<u>Total</u>
Manila	1	1	2
Rio de Janeiro	2	2	4
Santo Domingo	1	1	2
Canberra	2	2	4
Kuala Lumpur	2	2	4
New Delhi	2	2	4
Total	<u>10</u>	<u>10</u>	<u>20</u>

While this staffing appears to be reasonable, in view of the present concern for economy and the balance of payments problem, it would appear preferable to start each of these offices with only one Agent and one clerk. Thus, we would be increasing the number of Bureau employees on foreign assignment by 12 rather than 20, and doing not that which is desirable but that which is essential.

The opening of the proposed 6 offices with one Agent and one clerk each would increase our present quota of personnel on foreign assignment from 88 to 100. This would be presented to State Department for its approval after discussion with the President and/or Dr. Kissinger.

RECOMMENDATIONS:

1. That we retain our 17 existing Legal Attache Offices.

[Handwritten signature]

[Handwritten initials]

Memo for Mr. Tolson
Re: Foreign Operations - Legats

SECRET

2. That we reopen the Resident Agency at Hermosillo, Mexico, to cover an area presently being handled on road trip basis out of Monterrey, Mexico. No additional personnel required. If approved, Administrative Division to handle.

*Letter to Thomas Stern
LW 100, 9/17/71, TJF:DLH*

*Yes.
Vd*

JAD

Teletype to LW 100, 9/17/71, LDH:ndd

3. That the Director may wish to consider advising the President through Dr. Kissinger that in response to the President's request in May, we recommend expansion of foreign operations by reopening Manila, Rio de Janeiro and Santo Domingo; and opening Canberra, Kuala Lumpur and New Delhi. Also, that we are ready to do this whenever he so directs and arrangements can be perfected with the State Department.

*I shall discuss
matter with
Dr. K. H*

JAD

4. That upon receipt of White House approval of this proposal, the State Department be requested to authorize an increase in FBI personnel on foreign assignment from the present 88 to 100 and that other necessary arrangements be handled with State Department to open the new offices.

after Dr. K. has considered it.

*H
JAN*

JAD

*←
PST
7*

UNEXCISED - T

274-10/28

UNITED STATES GOVERNMENT

Memorandum

SECRET

Tolson	_____
DeLoach	_____
Mohr	_____
Bishop	_____
Brockman, C.D.	_____
Callahan	_____
Casper	_____
Conrad	_____
Dalbey	_____
Gale	_____
Ponder	_____
Rosen	_____
Tavel	_____
Walters	_____
Soyars	_____
Tele. Room	_____
Holmes	_____
Gandy	_____

TO : MR. TOLSON

DATE: September 7, 1971

FROM : J. K. PONDER

NON-EXCISED

SUBJECT: INSPECTION - OFFICE OF LEGAL ATTACHE

BONN, GERMANY

INSPECTOR FLETCHER D. THOMPSON

8/17 - 22/71

NATIONAL SECURITY INFORMATION

Unauthorized Disclosures

SUMMARY Subject to Criminal Sanctions

Officials: George A. Van Noy, Legal Attache (Legat) since 9/19/55. Floyd R. Peters, Assistant Legat since 6/28/70 and Number One Man since 2/19/71. (John C. F. Morris, Assistant Legat 12/29/62 - 7/31/71). Last inspection: 4/20 - 27/70.

Physical Condition and Maintenance - Very Good (Last Inspection - Very Good). Space on sixth floor of American Embassy Building in suburb of Bonn. Office is secure with Marine Guards on duty in building lobby after working hours and periodic security checks made of our space. Office is neat, well arranged and maintained, but extremely crowded. Legat instructed to pursue negotiations with Embassy officials for additional space, contiguous to existing space if possible, but office may have to move to another floor in same building. Legat to furnish estimates and recommendations to Bureau before making any commitments. No Bureau cars assigned.

REC-140 107-539274-1-62 (5- Thompson)

Investigative Operations - Very Good (Last Inspection Excellent). West Germany, the Netherlands and Austria (since 12/70) covered by Bonn Office. Active case load (majority of security nature) 328 as of 7/31/71 (248 last inspection). Over 12-month period case load and cases closed per Agent well above average each month; delinquency below average each month. Communications Intercept Service (CIS), which makes available information concerning mail sent from United States to persons in East Germany, continues to produce valuable material, including information on Left Wing organizations in U. S. and travel of Security Index subjects and communists to Eastern Bloc. Increasing volume of material (over 5600 items since last inspection) has burdened both Agent and clerical personnel. (Material is provided in raw form and must be translated -- if in German -- analyzed, searched and transmitted to Bureau.) Since April, 1971, necessary to transmit some items to Bureau in bulk without benefit of thorough analysis in Bonn Office. Inspector

Enclosure sent 9-8-71

- 1 - Mr. Callahan (Attention Mr. H. N. Bassett) (Sent Separately)
- 1 - Mr. Brennan (Attention Foreign Liaison Desk) (Sent Separately)
- 1 - Personnel Files George A. Van Noy and Floyd R. Peters

Classified by 6283
 Exempt from GDS
 Category 1
 Classification Indefinite

110-448/wsc
 370

FDT:bhg (6)

CONTINUED - OVER

SECRET

Memorandum to Mr. Tolson
Re: Inspection - Office of Legal Attache, Bonn

SECRET

determined experienced clerical employee (Miss Cuddy) capable of reviewing and processing much of this material. Assignment of this clerk-stenographer full time to project would release Agent personnel to handle other important responsibilities, primarily in the field of gathering high-level intelligence (HILEV). Since last inspection 78 Security Index subjects known to have visited or resided in Bonn territory; 76 other security subjects known to be residing these countries. Sources providing coverage on activities. In criminal field Bonn reported location of 22 fugitives and/or Selective Service delinquents in last 12 months. Valuable information also developed in several car theft ring cases, major thefts in U. S. and activities in Black Panther movement in Algeria. While 7 HILEV items worthy of dissemination to the White House (3 in August) have been submitted, there is a definite need for expansion and intensification. Positive program for this purpose outlined. Legat of definite opinion great majority accomplishments in all areas achieved only because of presence our personnel and would not have been possible through normal diplomatic channels. No substantive errors detected.

Administrative Operations - Excellent (Last Inspection - Excellent). Office is capably administered. Chief Clerk's Office operating efficiently and work current. Stenographic production above average even though time spent on clerical duties is high. Continued close attention to all administrative functions stressed.

Personnel Matters - Very Good (Last Inspection - Very Good). Personnel complement 3 Agents and 4 clerk-stenographers (2 Agents and 3 clerk-stenographers last inspection). Thorough analysis by Inspector of work load, types of cases, and experience of personnel determined Agents required to spend too much time in office handling high volume of security matters (Communications Intercept Service). Overtime essential, productive and equitably shared. Time in office higher than should be due to above-mentioned processing of mail. Morale appears high. Language/ability Agent personnel satisfactory.

Contacts - Excellent (Last Inspection - Excellent). Productive and cordial liaison maintained with diversified contacts, both American and foreign, throughout territory. Legat recognizes need for cultivating and expanding contacts, especially in HILEV field. Instructed to do so. All contacts expressed highest regard for and confidence in Director and our Bonn personnel.

RECOMMENDATIONS

1. George A. Van Noy, GS-16 at \$33,757, aged 57, nonveteran, not on probation. Legat since 9/19/55; fully available. Makes excellent personal appearance;

- 2 - CONTINUED - OVER

SECRET

SECRET

Memorandum to Mr. Tolson
Re: Inspection - Office of Legal Attache, Bonn

quiet, but engaging personality; effective Bureau representative; highly respected by associates and others with whom he has contact. Fully qualified to continue as Legat. If approved, attached letter to Van Noy will summarize inspection findings.

JWP

2. Floyd R. Peters, GS-15 at \$25,059, aged 54, veteran, not on probation, Assistant Legat since 6/28/70, Number One Man since 2/19/71. Peters is a dedicated, hard-working Agent who is capably discharging his responsibilities. Qualified to continue as Assistant Legat and for further administrative advancement commensurate with needs of Bureau; fully available.

JWP

3. The Bonn Office handles a high volume of cases in security, criminal, liaison, intelligence and related areas. Legat feels, and inspection confirms, that great majority of accomplishments achieved only because of presence of our personnel on the scene. It is recommended, therefore, that office of Legal Attache, Bonn, be continued.

G.K.
A

←
PETER
7

JWP

JWP

SECRET

UNITED STATES GOVERNMENT

Memorandum

SECRET

NON-EXCISED

- Tolson _____
- Felt _____
- Sullivan _____
- Mohr _____
- Wick _____
- DeLoach _____
- Casper _____
- Callahan _____
- Conrad _____
- Dalbey _____
- Gale _____
- Rosen _____
- Tavel _____
- Walters _____
- Soyars _____
- Telo. Room _____
- Holmes _____
- Gandy _____

TO : MR. TOLSON

DATE: August 24, 1971

FROM : J. K. PONDER

SUBJECT: INSPECTION - OFFICE OF LEGAL ATTACHE
TOKYO, JAPAN
INSPECTOR MASON G. WORKING
7/31 - 8/6/71

NATIONAL SECURITY INFORMATION
Unauthorized Disclosure
Subject to Criminal Sanctions

SUMMARY

Officials: Harold L. Child, Jr., Legal Attache (Legat) 11/14/54 to 12/4/67 and since 6/26/69. Roderick V. Precht, Jr., Assistant Legat 6/12/66 to 11/7/67; Legat 11/7/67 to 5/28/69. Assistant Legat since 5/28/69. Last inspection: 11/14 - 22/70.

Physical Condition and Maintenance - Very Good (Last Inspection - Very Good). Office located second floor, American Embassy Annex, fireproof reinforced concrete building, downtown Tokyo. Space adequate and, although old, is neat and businesslike in appearance. Contracts being obtained to refurbish which will modernize appearance. Security of space and documents stressed. No security violations. No Bureau automobiles assigned.

Investigative Operations - Excellent (Last Inspection - Very Good). Office covers Japan, Okinawa, Taiwan and South Korea. Active cases 307; steady growth in case load past year. Cases per Agent exceed other Legats and delinquency below Legat averages every month since last inspection. No substantive errors detected in 373 files reviewed. Cases being closely followed by Legat through established contacts and sources. 70% of case load security; 4% criminal; 26% applicant and other. Japan Communist Party (JCP), with estimated membership 250,000, has achieved increasing power in Japanese political positions -- considered major threat to internal security of Japan. Soviets continue to be major financial contributor to JCP. \$222,000 contributed secretly to aid in June, 1971, elections. Communist front organizations active, following doctrines of JCP, Communist China and USSR. Strength of radical New Left group increasing; anticipate violent protest against policies of Japanese Government and U. S. involvement in Vietnam war. Black extremist activities confined primarily to promoting unrest among black servicemen; no organized black extremist groups. Coverage of Security Index subjects and subjects of security cases very effective. Six Bureau fugitives and nine Selective

Enclosure

- 1 - Mr. Callahan (Attention Mr. H. N. Bassett) (Sent Separately)
- 1 - Mr. Brennan (Attention Foreign Liaison Desk) (Sent Separately)
- 1 - Personnel Files Harold L. Child, Jr. and Roderick V. Precht, Jr.

530311-10
Classified by 6283
Date of Declassification Indefinite
CDS Category 3

3/10

Memorandum to Mr. Tolson
Re: Inspection - Office of Legal Attache
Tokyo, Japan

SECRET

Service delinquents located in 9-month period since last inspection (comparable to 9 and 14 in one-year period, last inspection). No recoveries this inspection or last. Since inception High Level Intelligence (HILEV) Program in September, 1970, 43 HILEV items submitted; 20 disseminated to White House. Legat affording aggressive and imaginative attention to HILEV Program. High-level sources and contacts furnishing valuable intelligence data -- instructed to develop additional sources and contacts of this caliber. Legat extremely knowledgeable of political, social, economic, and intelligence situation in territory covered.

Administrative Operations - Excellent (Last Inspection - Excellent). Chief Clerk's Office well organized and operating efficiently. Form errors and misfiled index cards well below field averages. Stenographic accuracy and production very high - no delinquency. Agent and clerical personnel operating at peak performance to handle intensified intelligence program.

Personnel Matters - Excellent (Last Inspection - Excellent). Complement of 2 Agents and 2 clerk-stenographers, same as last inspection. Present complement adequate, not excessive - Legat agrees. Agent and clerical overtime exceptionally high, but essential, productive and equitably shared. Clerical employees refuse to request compensatory leave or overtime pay although overtime necessary and essential to fulfill assigned duties. Training procedures effective. No Agents overweight, unavailable or on limited duty. Morale outstanding.

Contacts - Excellent (Last Inspection - Excellent). Quality high-level contacts maintained in strategic branches of police and security agencies in all countries covered. Program very effective. 71 contacts developed since last inspection. 9 National Academy (NA) graduates occupy responsible positions; 3 additional candidates in current NA session. All persons contacted during inspection spoke highly of Director, FBI and Tokyo personnel.

RECOMMENDATIONS

1. Harold L. Child, Jr., GS-17 at \$36,000, aged 51, nonveteran, not on probation. Legat Tokyo 11/14/54 to 12/4/67 and since 6/26/69. Makes excellent personal appearance and has excellent personality. Conscientious, aggressive, highly intelligent and capable administrator. Excellent command of Japanese language. Extremely well qualified to continue in present assignment or for further advancement. If approved, attached letter will advise him of inspection findings.

SECRET

Memorandum to Mr. Tolson
Re: Inspection - Office of Legal Attache
Tokyo, Japan

SECRET

2. Roderick V. Prechtl, Jr., GS-15 at \$26,675, aged 45, veteran, not on probation. Assistant Legat, Tokyo, 6/12/66 to 11/7/67; Legat 11/7/67 to 5/28/69; and Assistant Legat since 5/28/69. Makes excellent personal appearance. Has mature, intelligent, and businesslike approach to all assignments and responsibilities. He is most personable, very enthusiastic, and loyal. Has capably demonstrated ability to handle Legat position in past and well qualified for administrative advancement. Retention in present position justified.

Q
IM

3. During current inspection all pending investigative matters and overall operation of Legat, Tokyo, subjected to penetrative and in-depth analysis. All phases of Legat operation being afforded vigorous attention with particular emphasis on obtaining HILEV data. Presence of Legat has resulted in obtaining HILEV data disseminated to President and other Government agencies, which information would not be available without Bureau representative on scene. To fulfill our obligations concerning internal security of U. S. and particularly to the President, it is essential that Legat, Tokyo, be retained.

V7

AM Pm

GR
H

SECRET

SS@ Access

4/75
8/5/75 request

III-A

SECTION 8 OF MOI

RETAIN

This document is prepared in response to your request and is not for dissemination outside your Committee. Its use is limited to official proceedings by your Committee and the content may not be disclosed to unauthorized personnel without the express approval of the FBI .

274-10128

A. INTRODUCTION TO FBI LABORATORY

1. Functions
 - a. Make examinations of physical evidence found at scenes of crimes
 - b. Aid field in technical problems
 - c. Conduct research
2. Organization
 - a. Cryptanalysis and Translation Section
 - b. Document Section
 - c. Physics and Chemistry Section
 - d. Radio Engineering Section

B. FACILITIES OF FBI LABORATORY

1. Availability
 - a. In all FBI investigations, regardless of whether an examination made previously by another expert
 - b. To all other Federal agencies, USAs, military tribunals, etc., in both civil and criminal matters. Requests from USAs for laboratory examinations and testimony of FBI Laboratory experts should be made through FBI field offices.
 - c. To all duly constituted state, county, and municipal law enforcement agencies in U. S. and territorial possessions in connection with their official investigations, but in criminal matters only
 - d. All laboratory services, including expert witnesses, rendered free of all cost to contributing agency
 - e. In offering these services, experience has dictated following limitations in interest of economy, as well as for proper administration of justice:
 - (1) No examination will be made if any evidence in an individual case has been subjected previously to a technical examination in same technical field.
 - (2) No testimony will be furnished if testimony on same technical subject and in same case given for prosecution by another expert.
 - (3) No request for examination will be accepted from a non-Federal law enforcement agency in connection with criminal cases if:
 - (a) It is indicated that a civil case will grow out of it and if
 - (b) The evidence will necessarily be destroyed during the course of the examination or evidence is to be examined for the presence of some foreign material
 - f. A search through the national fraudulent check file will be made even though the check was previously searched through a check file maintained by a state or local agency or technically examined by such other agency.
 - g. Field should notify Bureau of any local controversy involving case in which evidence is submitted to FBI Laboratory.
 - h. A Federal court may order the Government to permit the defendant, prior to trial, to inspect and copy or photograph the results or reports of physical and mental examinations, and of scientific tests or experiments made in connection with the particular case. However, upon a sufficient showing, the court may at any time order that the discovery or inspection be denied, restricted, or deferred, or make such other order as is appropriate. (Rule 16.)
2. How to request an FBI Laboratory examination
 - a. All requests should be made by letter to Director, in [triplicate,] marked "Attention FBI Laboratory."
 - b. Forward evidence by registered (air) mail, railway express, air express, or airfreight. Do not send by parcel post or regular mail.
 - c. Furnish name of subject or suspect and victim, if known.
 - d. Set out nature of violation.
 - e. Make a list of evidence.
 - f. State generally what types of examinations are desired.
 - g. Set out basic facts concerning crime insofar as they pertain to laboratory examination.
 - h. Make reference to previous correspondence, if any.
 - i. All outside agencies should include a statement as to whether evidence was examined previously by another expert in same technical field.
 - j. State what disposition should be made of evidence.

3. How to prepare bulky evidence for shipment
 - a. Take every precaution to protect latent fingerprints.
 - b. Choose a box suitable for size and durability.
 - c. Do not place evidence from more than one case in same package.
 - d. Wrap each item separately to avoid contamination.
 - e. Pack securely to avoid damage while in transit.
 - f. Seal box with gummed tape and label "EVIDENCE."
 - g. Place copy of letter of transmittal in an envelope and mark "INVOICE." Stick this invoice to outside of box you have just sealed.
 - h. Enclose this box with an additional wrapper and seal with gummed tape.
 - i. If box is made of wood, invoice envelope may be attached to top under a clear plastic cover.
 - j. All evidence must be shipped by registered (air) mail, railway express, air express, or air freight. Do not use regular mail or parcel post.
 - k. Letters and packages requiring a laboratory examination only should be addressed to "Director, Federal Bureau of Investigation, Washington, D. C. 20535, Attention FBI Laboratory."
 - l. Letters and packages containing evidence requiring a fingerprint examination only should be forwarded to Bureau, marked "Attention Identification Division, Latent Fingerprint Section."
 - m. Letters and packages containing material for photographic processing only should be forwarded to Bureau, marked "Attention Mechanical Section." If package contains exposed film, word "Film" should appear on outside of package.
 - n. Letters and packages containing evidence requiring both photographic processing and a laboratory examination of any kind should be forwarded to Bureau, marked "Attention FBI Laboratory."
 - o. Letters and packages containing evidence requiring both a fingerprint examination and a laboratory examination of any kind should be forwarded to Bureau, marked "Attention FBI Laboratory."
 - p. Letters and packages containing material requiring both photographic processing and a fingerprint examination should be forwarded to Bureau, marked "Attention Identification Division, Latent Fingerprint Section."
4. Grand juries and preliminary hearings
 - a. Laboratory experts available to testify at such hearings, but requests for appearance should not be made unless absolutely necessary.
 - b. In most cases laboratory report, an affidavit, or testimony of Agent handling case will suffice.
 - c. After all attempts to obviate appearance of expert have been exhausted, Bureau should be advised in detail of unusual circumstances which make presence of expert absolutely necessary.
5. Outside experts
 - a. Bureau needs information on ability, qualifications, and reliability.
 - b. Gather information from various sources, including newspapers.
6. Copies of laboratory reports
 - a. To contributing office
 - b. To other offices for which copies are requested by contributing office
 - c. To still other offices which may have an interest in the case on basis of Laboratory's findings
7. The collection and preservation of physical evidence
 - a. Must be legally obtained
 - b. Must be properly described with detailed notes
 - c. Must be labeled, initialed, and dated for proper identification
 - d. Must be properly handled, wrapped, and prepared for shipment
 - e. Legal chain of custody must be maintained.
 - f. For details, see chart.

FEDERAL BUREAU OF INVESTIGATION
UNITED STATES DEPARTMENT OF JUSTICE

Proper Sealing of Evidence

The method shown below permits access to the invoice letter without breaking the inner seal. This allows the person entitled to receive the evidence to receive it in a sealed condition just as it was packed by the sender.

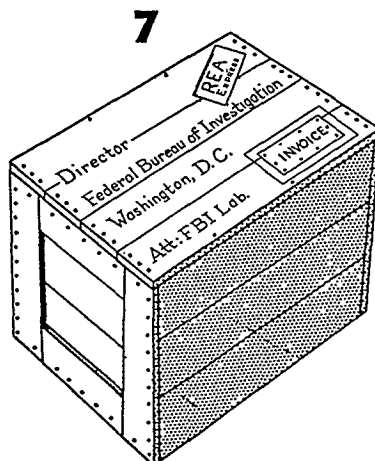
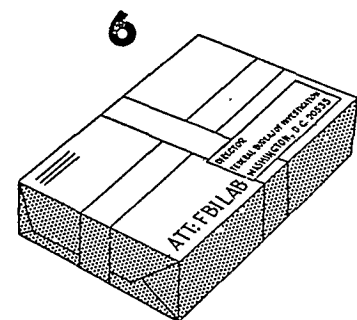
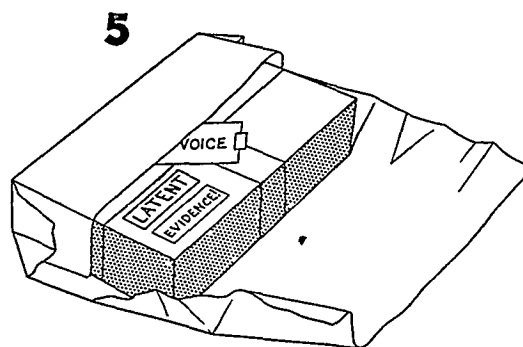
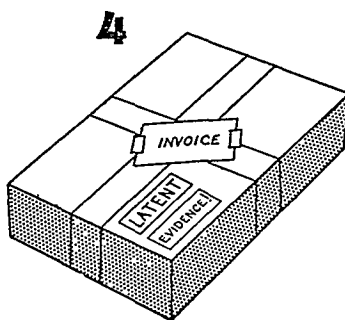
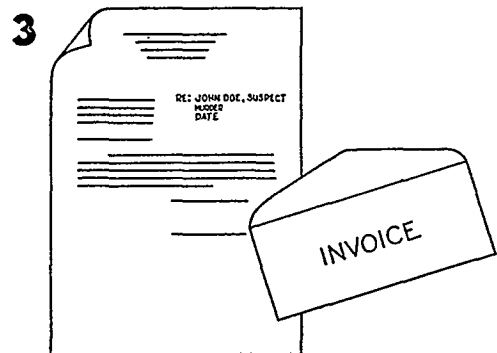
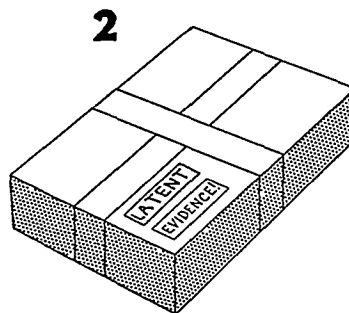
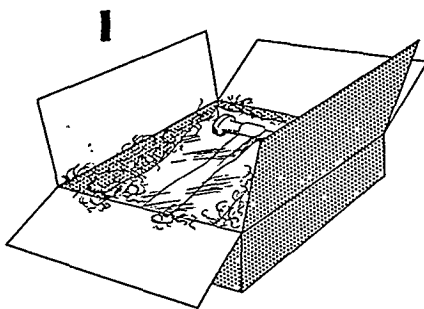

1. Pack bulk evidence securely in box.
2. Seal box and mark as evidence. Mark "Latent" if necessary.
3. Place copy of transmittal letter in envelope and mark "Invoice."
4. Stick envelope to outside of sealed box.
5. Wrap sealed box in outside wrapper and seal with gummed paper.
6. Address to Director
Federal Bureau of Investigation
Washington, D. C. 20535 and mark "Attention FBI Laboratory."
7. If packing box is wooden -- tack invoice envelope to top under a clear plastic cover.



*CHART TO BE USED IN SUBMITTING

SPECIMEN	IDENTIFICATION	AMOUNT DESIRED	
		STANDARD	EVIDENCE
Abrasives, including carborundum, emery, sand, etc.	On outside of container. Type of material. Date obtained. Name or initials.	Not less than one ounce	All
Acids	Same as above	One pint	All to one pint
Adhesive tape	Same as above	Recovered roll	All
Alkalies -- caustic soda, potash, ammonia, etc.	Same as above	One pint liquid One pound solid	All to one pint All to one pound
Ammunition	Same as above	Two	
Anonymous letters, extortion letters, bank robbery notes	Initial and date each document unless legal aspects or good judgment dictates otherwise.		All
Blasting caps	On outside of container. Type of material, date obtained, and name or initials.		All
Blood:			
1. Liquid Known samples	Use adhesive tape on outside of test tube. Name of donor, date taken, doctor's name, name or initials of submitting Agent or officer.	1/6 ounce (5cc) collected in sterile test tube	All
2. Drowning cases	Same as above	Two specimens: one from each side of heart	
3. Small quantities:			
a. Liquid Questioned samples	Same as above as applicable		All to 1/6 ounce (5cc)
b. Dry stains Not on fabrics	On outside of pillbox or plastic vial. Type of specimen, date secured, name or initials.		As much as possible

*This chart is not intended to be all-inclusive. If evidence to be submitted is not found herein, consult the specimen list for an item most similar in nature and submit accordingly.

CHART TO BE USED IN SUBMITTING

SPECIMEN	IDENTIFICATION	AMOUNT DESIRED	
		STANDARD	EVIDENCE
4. Stained clothing, fabric, etc.	Use tag or mark directly on clothes. Type of specimens, date secured, name or initials.		As found
Bullets (not cartridges)	Initials on base		All found
Cartridges	Initials on outside of case near bullet end	Two	
Cartridge cases (shells)	Initials preferably on inside near open end or on outside near open end.		All
Charred or burned paper	On outside of container indicate fragile nature of evidence, date obtained, name or initials.		All
Checks (fraudulent)	See anonymous letters.		All
Check protector, rubber stamp and dater stamp sets, known standards Note: Send actual device when possible.	Place name or initials, date, name of make and model, etc., on sample impressions.	Obtain several copies in full word-for-word order of each questioned check-writer impression. If unable to forward rubber stamps, prepare numerous samples with different degrees of pressure.	
Clothing	Mark directly on garment or use string tag. Type of evidence, name or initials, date.		All
Codes, ciphers, and foreign language material	As anonymous letters		All

EVIDENCE TO THE FBI LABORATORY

<u>PRESERVATION</u>	<u>WRAPPING AND PACKING</u>	<u>TRANSMITTAL</u>	<u>MISCELLANEOUS</u>
If wet when found, dry by hanging. USE NO HEAT TO DRY. No preservative.	Each article wrapped separately and identified on outside of package. Place in strong box packed to prevent shifting of contents.	Registered mail or air or RR express	
None	Place in cotton or soft paper. Place in pill, match, or powder box. Pack to prevent shifting during transit.	Registered mail	
None	Same as above	RR express only	
None	Same as above	Registered mail	
None	Pack in rigid container between layers of cotton.	Registered mail	Added moisture, with atomizer or otherwise, not recommended
None	See anonymous letters.	Registered mail	Advise what parts questioned or known. Furnish physical description of subject.
None	See anonymous letters or bulky evidence wrapping instructions.	Registered mail	Do not disturb inking mechanisms on printing devices.
None	Each article individually wrapped with identification written on outside of package. Place in strong container.	Registered mail or RR or air express	Leave clothing whole. Do not cut out stains. If wet, hang in room to dry before packing.
None	As anonymous letters	As anonymous letters	Furnish all background and technical information pertinent to examination.

CHART TO BE USED IN SUBMITTING

SPECIMEN	IDENTIFICATION	AMOUNT DESIRED	
		STANDARD	EVIDENCE
Drugs:			
1. Liquids	Affix label to bottle in which found including name or initials and date.		All to one pint
2. Powders, pills, and solids	On outside of pillbox. Name or initials and date.		All to $\frac{1}{4}$ pound
Dynamite and other explosives	Consult the FBI Laboratory and follow their telephonic or telegraphic instructions.		
Fibers	On outside of sealed container or on object to which fibers are adhering	Entire garment or other cloth item	All
Firearms	Attach string tag. Name of weapons, caliber, serial number, date found, name or initials. Serial number in notes.		All
Flash paper	Initials and date	One sheet	All
Fuse, safety	Attach string tag or gummed paper label, name or initials, and date.	One foot	All
Gasoline	On outside of all-metal container, label with type of material, name or initials, and date.	One quart	All to one gallon
Glass fragments	Adhesive tape on each piece. Name or initials and date on tape. Separate questioned and known.		All
Glass particles	Name or initials, date on outside of sealed container	3" piece of broken item	All
Gunpowder tests:			
1. Paraffin	On outside of container. Type of material, date, and name or initials.		All
2. On cloth	Attach string tag or mark directly. Type of material, date, and name or initials.		All
Hair	On outside of container. Type of material, date, and name or initials.	Dozen or more full length hairs from different parts of head	All

EVIDENCE TO THE FBI LABORATORY

PRESERVATION	WRAPPING AND PACKING	TRANSMITTAL	MISCELLANEOUS
None	If bottle has no stopper, transfer to glass-stoppered bottle and seal with adhesive tape.	Registered mail or RR or air express	Mark "Fragile." Determine alleged normal use of drug and if prescription, check with druggist to determine supposed ingredients.
None	Seal to prevent any loss by use of tape.	Registered mail or RR or air express	
None	Folded paper or pillbox. Seal edges and openings with tape.	Registered mail	Do not place loose in envelope.
Keep from rusting.	Wrap in paper and identify contents of package. Place in cardboard box or wooden box.	Registered mail or RR or air express	Unload all weapons before shipping.
Fireproof, vented location away from any other combustible materials. If feasible, immerse in water.	Individual polyethylene envelopes double wrapped in manila envelopes. Inner wrapper sealed with paper tape.	Five sheets (8 x 10 $\frac{1}{2}$) surface mail parcel post Over 5 sheets telephonically consult FBI Laboratory.	Mark inner wrapper "Flash Paper" "Flammable"
None	Place in manila envelope, box, or suitable container.	Registered mail or RR or air express	
Fireproof container	Metal container packed in wooden box	RR express only	
Avoid chipping.	Wrap each piece separately in cotton. Pack in strong box to prevent shifting and breakage. Identify contents.	Registered mail or RR or air express	Mark "Fragile."
None	Place in pillbox, plastic or glass vial; seal and protect against breakage.	Registered mail	Do not use envelopes.
Containers must be free of any nitrate-containing substance. Keep cool.	Wrap in waxed paper or place in sandwich bags. Lay on cotton in a substantial box. Place in a larger box packed with absorbent material.	Registered mail	Use "Fragile" label. Keep cool.
None	Place fabric flat between layers of paper and then wrap, so that no residue will be transferred or lost.	Registered mail	Avoid shaking.
None	Folded paper or pillbox. Seal edges and openings with tape.	Registered mail	Do not place loose in envelope.

CHART TO BE USED IN SUBMITTING

SPECIMEN	IDENTIFICATION	AMOUNT DESIRED	
		STANDARD	EVIDENCE
Handwriting and hand printing, known standards	Name or initials, date, from whom obtained, and voluntary statement should be included in appropriate place.	See footnote.*	
[[Magnetic tape recordings	Initials and date on tape reel and dull side of loose end of tape	Submit original recording.	All
Matches	On outside of container. Type of material, date, and name or initials.	One to two books of paper. One full box of wood.	All
Medicines (See drugs.)			

*Duplicate the original writing conditions as to text, speed, slant, size of paper, size of writing, type of writing instruments, etc. Do not allow suspect to see questioned writing. Give no instructions as to spelling, punctuation, etc. Remove each sample from sight as soon as completed. Suspect should fill out blank forms in check cases (FD-352). In hand printing cases, both uppercase (capital) and lowercase (small) samples should be obtained. In forgery cases, obtain sample signatures of the person whose name is forged. Have writer prepare some specimens with hand not normally used. Obtain undictated handwriting when feasible.

EVIDENCE TO THE FBI LABORATORY

<u>PRESERVATION</u>	<u>WRAPPING AND PACKING</u>	<u>TRANSMITTAL</u>	<u>MISCELLANEOUS</u>
---------------------	-----------------------------	--------------------	----------------------

None

See anonymous letters.

Registered mail

Avoid placing near electrical or magnetic fields, and temperature extremes (heat or cold)

Use special evidence containers available in each field office. Special evidence containers are reusable and adhesive materials should not be applied to fiberboard exterior. Containers should be wrapped separately and adhesive materials applied to outer wrapping. If magnetic tapes are too large for special evidence containers, they should be packed in sturdy cartons with a minimum of four inches of packing material surrounding all sides of tape. All special evidence containers in excess of needs should be returned to FBI Laboratory.

Registered mail or air express

Do not bend or stretch tape. Identify speed of recording and track configuration. Submit transcript of recording if applicable.]

Keep away from fire.

Metal container and packed in larger package to prevent shifting. Matches in box or metal container packed to prevent friction between matches.

RR express or registered mail

"Keep away from fire" label

CHART TO BE USED IN SUBMITTING

SPECIMEN	IDENTIFICATION	AMOUNT DESIRED	
		STANDARD	EVIDENCE
Metal	Same as above	One pound	All to one pound
Oil	Same as above	One quart together with specific- cations	All to one quart
Obliterated, eradicated, or indented writing	See anonymous letters.		All
Organs of body	On outside of container. Victim's name, date of death, date of autopsy, name of doctor, name or initials.		All to one pound
Paint:			
1. Liquid	On outside of container. Type of material, origin if known, date, name or initials.	Original unopened container up to 1 gallon if possible	All to $\frac{1}{4}$ pint
2. Solid (paint chips or scrapings)	Same as above	At least $\frac{1}{2}$ sq. inch of solid, with all layers represented	All. If on small object send object.

EVIDENCE TO THE FBI LABORATORY

PRESERVATION	WRAPPING AND PACKING	TRANSMITTAL	MISCELLANEOUS
Keep from rusting.	Use paper boxes or containers. Seal and use strong paper or wooden box.	Registered mail or RR or air express	Melt number, heat treatment, and other specifications of foundry if available
Keep away from fire.	Metal container with tight screw top. Pack in strong box using excelsior or similar material	RR express only	DO NOT USE DIRT OR SAND FOR PACKING MATERIAL.
None	See anonymous letters.	Registered mail	Advise whether bleaching or staining methods may be used. Avoid folding.
None to evidence. Dry ice in package not touching glass jars.	Plastic or all-glass containers (glass jar with glass top)	RR or air express	"Fragile" label. Keep cool. Metal top containers must not be used. Send autopsy report.
None	Friction-top paint can or large-mouth, screw-top jars. If glass, pack to prevent breakage. Use heavy corrugated paper or wooden box.	Registered mail or RR or air express	
Wrap so as to protect smear.	If small amount, round pill-box or small glass vial with screw top. Seal to prevent leakage. Envelopes not satisfactory.	Registered mail or RR or air express	Do not pack in cotton. Avoid contact with adhesive materials.

EVIDENCE TO THE FBI LABORATORY

PRESERVATION	WRAPPING AND PACKING	TRANSMITTAL	MISCELLANEOUS
Allow casts to cure (dry) before wrapping.	Wrap in paper and cover with suitable packing material to prevent breakage. Do not wrap in unventilated plastic bags.	Registered mail or RR or air express	Use "Fragile" label. Mix approximately four pounds of plaster to quart of water.
	Wrap securely.	Registered mail	
	Use containers, such as ice-cream box, pillbox, or plastic vial. Seal to prevent any loss.	Registered mail or RR or air express	Avoid use of glass containers and envelopes.
None	Prints in dust are easily damaged. Fasten print or lift to bottom of a box so that nothing will rub against it.	Registered mail	Always rope off crime scene area until shoe prints or tire treads are located and preserved.
	Wrap each tool in paper. Use strong cardboard or wooden box with tools packed to prevent shifting.	Registered mail or RR or air express	
Cover ends bearing toolmarks with soft paper and wrap with strong paper to protect ends.	After marks have been protected, wrap in strong wrapping paper, place in strong box, and pack to prevent shifting.	Registered mail or RR or air express	
None	See anonymous letters.	Registered mail	Examine ribbon for evidence of questioned message thereon. For carbon paper samples either remove ribbon or place in stencil position.
None. Use any clean bottle with leakproof stopper.	Bottle surrounded with absorbent material to prevent breakage. Strong cardboard or wooden box.	Registered mail	
	Wrap securely.	Registered mail	Do not kink wire.
	Wrap securely.	Registered mail	

8. Fingerprint examinations
 - a. All latent fingerprint examinations made by Latent Fingerprint Section in Identification Division
 - b. Latent fingerprint examinations not made unless specifically requested by field
 - c. Field should be alert to advise of situations where permanent staining is inadvisable. Iodine fuming only nonstaining method available. Silver nitrate leaves permanent stains.
 - d. Iodine fuming and silver nitrate methods usually unsuccessful if fingerprints more than a few months old
9. [Polygraph or lie detector
 - a. General information
 - (1) The polygraph is an instrument designed to record psychophysiological responses during a carefully controlled interrogation which may indicate deception when properly evaluated by the examiner. (Relative changes in blood pressure, heart rate, respiration, and psychogalvanic skin responses.)
 - (2) Special Agents trained as polygraph examiners are strategically located throughout the field.
 - (3) Opinions from interpretations of polygraph examinations are generally not admissible in court.
 - (4) Statements made while polygraph used and admissions obtained are admissible as evidence.
 - b. Policy
 - (1) The FBI does not consider the polygraph technique sufficiently precise to permit absolute judgment of guilt or nonguilt (lie or truth) without qualifications.
 - (2) The polygraph is used selectively as an investigative aid and the results are considered within the context of a complete investigation. The polygraph can be helpful to implement an interrogation and provide investigative direction, but the FBI does not rely on it solely or use it as a substitute for logical investigation.
 - (3) FBIHQ must authorize use in every instance.
 - (4) FD-328 "Consent to Interview With Polygraph" must be signed by each person prior to examination. The consent forms and polygraph charts should be retained as exhibits in case file.
 - (5) FBIHQ will not authorize outside agency polygraph use in Bureau case and generally will not make available polygraph examinations for outside agency in non-Bureau matters. Exceptions will be considered on individual basis.

c. Procedural requirements

- (1) Request for polygraph should state facts which recommend its use. Ordinarily made to Bureau by letter; by airtel, teletype, or telephone if situation requires. (To insure that all facets can be carefully considered by the Bureau in granting or denying authority to use the polygraph, field communications should contain the following data:
 - (a) Concise resume of case
 - (b) Identity of persons to be afforded polygraph examination. Show age if it is to be a factor in decision. If a minor, indicate whether waiver can be obtained from parents or guardian. Specify if persons are controversial or prominent figures. Specify if persons have any known physical or mental disabilities.
 - (c) Indicate how individuals to be afforded polygraph examination fit into case and indicate what is expected to be gained through use of this technique.
 - (d) If persons to be afforded examination are in custody, so indicate and advise whether full security and control can be assured for use of this technique.
 - (e) Specifically consider whether use of the polygraph technique might jeopardize any other prosecutive action, local or Federal. If so, furnish details.
 - (f) Requests for Bureau authority should be approved by the SAC or the official acting in his absence. Communications to the Bureau should clearly indicate if expedite handling is required and whether the subject has had prior polygraph examination in the case and, if so, the results.
- (2) If Bureau authority issued by telephone, a memorandum identifying Bureau official authorizing use of polygraph shall be prepared for field office case file.
- (3) Copy all correspondence with Bureau regarding polygraph designated for Bureau file 80-5. This copy marked for FBI Laboratory; e.g., 1 - FBI Laboratory (80-5). (Offices assigned polygraphs and examiners designate copies to appropriate Bureau subfile.)

d. Reporting procedures

- (1) Polygraph interviews are reported to Bureau in summary form by letter. Airtel, teletype, or telephone communications used if situation requires.
- (2) No direct reference to polygraph made in investigative reports. Should be referred to only on cover page.
- (3) When necessary, USA advised of polygraph test in separate letter.]

[C. CRYPTANALYSIS, [GAMBLING,] AND TRANSLATION

1. Cryptanalysis

a. Cryptosystems

(1) Substitution

- (a) Identity of plaintext letters is changed but relative position remains the same.
- (b) Code is special form of substitution in which groups of random characters represent plaintext letters, words, phrases, sentences.

[(c) Telephone and house number encipherment wherein numbers are changed to letters or symbols according to specific keys. Sometimes also involves transposition.]

(2) Transposition

Plaintext letters retain their identity but change position in relation to one another.

(3) Combination

Involves both substitution and transposition

(4) Concealment (open code)

- (a) Secret message concealed within text of innocuous-appearing communication or verbal transmission
- (b) Characterized by overabundance of errors, unusual marks, awkward wording, peculiar subject matter

[(5) Authorship Identification

- (a) Characteristics of style which tend to identify, as identical or not, the writers or speakers of textual or oral material
- (b) Identification of ethnic, educational, and residence background primarily from oral material
- (c) These examinations are for investigative purposes and not for testimony.]

b. Cryptomaterials

- (1) Used, among others, by intelligence organizations, political agents, criminals
- (2) Purpose is secrecy and economy
- (3) Be alert for code books; cipher machines, pads, tables, and tapes; grilles (irregularly spaced holes in card or paper form); work sheets, particularly those on coordinate paper; alphabet disks, strips and wheels; literal slide rules; records with cryptic entries; innocuous-appearing books, magazines, and other periodicals which contain unusual penciled notations.

c. Submissions

- (1) Furnish code and cipher messages pertinent to investigations.
- (2) Suggested probable plaintext or substance thereof
- (3) All work notes and associated materials shown above
- (4) Subject's nationality, languages known, and any special background or training in this field
- (5) Additional data or information for reference files on code books, key books, cryptosystems, double-meaning expressions, cable addresses, radio procedure signals, unusual abbreviations, texts on cryptanalysis and cryptography, and foreign language dictionaries

2. Translation

- a. Designate correspondence "Attention FBI Laboratory."
- b. Handle material as evidence where applicable.
- c. Request summary unless full translation essential. If summary requested, provide description of information sought to assist translator.
- d. Two copies of translation usually furnished contributor
- e. In connection with translations disseminated by letter, whether dissemination is restricted to other interested divisions or includes outside agencies, translator's name must appear on yellow file copy only. If such translation is set forth from rough draft in investigative report, indicate identity of translator in cover page(s) accompanying report.
- f. Parenthetical comments made by translators for your information and guidance should not be incorporated in investigative reports.
- g. Review of foreign language material shall not be restricted to individual needs, generally speaking, but directed toward securing information pertinent to service as a whole.
- h. Office initiating request for translation has responsibility of taking whatever investigative action is necessary as a result and disseminating pertinent details contained therein to other interested divisions and [FBIHQ.]
- i. All translation work handled in field must be performed within office space, unless Bureau has approved contrary procedure, and if possible by fully qualified personnel who have passed appropriate translation tests.
- j. Those offices with translation facilities of any sort should notify Bureau of appreciable change in volume of such assignments and submit to reach Bureau no later than tenth of every month a report as of the first of total work on hand expressed in terms of man-days and broken down by languages, oral and written, with oldest date of receipt for each and estimate of personnel time per day assigned thereto. Fully describe work pending one month or more from date of letter and provide detailed explanation for delinquency.
- k. When material is sent directly from one office to another for translation, furnish copy of cover letter to Bureau, attention FBI Laboratory, and follow same procedure upon its return.
- l. Secure Bureau authorization before initiating review of any foreign-language magazine, newspaper, or periodical on recurring basis and thereafter notify Bureau when review discontinued. When such material is submitted to Bureau or another office for translation, forward issues as they are published or in case of dailies at least once a week and furnish letters of justification March 1, June 1, September 1, and December 1 showing necessity for review and setting forth all pertinent instructions for guidance of translator.
- m. As informants or other sources who have linguistic skills are developed, advise Bureau, attention FBI Laboratory, of their specific qualifications and reliability for handling occasional translation assignments.

3. Gambling

Following are types of specialized assistance and examinations available:

- a. Bookmaking
Analysis and interpretation of individual handwritten and printed systems of recorded wagering, policy, and numbers betting based on sports, horse and dog racing, bond, stock, and drawn numbers, etc.
- b. Gaming equipment of clubs, casinos, and carnivals
Determining whether playing cards, dice, slot machines, roulette wheels, and a wide variety of carnival games, etc., and related devices, [including] electrical, are deceptively marked and/or altered to permit cheating and increased percentages.
- c. Lottery, etc.
Determining source and items related to other similar items, such as lottery tickets, sports parlay cards, sweepstakes, tip tickets and boards, punchboards, machine tickets, etc.
- d. Loan sharking (shylocking) records
- e. Water-soluble and flash papers
Determining nature of specialized papers encountered in gambling operations (Note: See above chart for instructions on submission of flash paper.)

D. DOCUMENT EXAMINATION

1. Introduction

- a. Definition: Consists for most part of side-by-side comparison of handwriting, typewriting, and other written or printed matter
- b. Testimony accepted by courts for many years
- c. Conclusions positive and reliable when examinations conducted by competent experts
- d. Age, sex, character, etc., cannot be determined from handwriting.

2. Identification and submission of questioned documents
 - a. Initial and date each document unless legal aspects or good judgment dictates otherwise. If for some reason questioned documents should not be initialed, use either of following procedures:
 - (1) Place in individual clear plastic envelopes, along with a slip of paper bearing Agent's initials, date, and other pertinent information; or
 - (2) Place in other suitable individual envelopes, on the outside of which show Agent's initials, date, and other pertinent information.
 - b. Place in standard 8 $\frac{1}{2}$ - by 11-inch clasped enclosure envelope (larger, if necessary) and seal with "Evidence" tape or transparent tape. Enclosure envelope should bear following information on flap side:
 - (1) The wording "Enclosure(s) to Bureau from (name of submitting field office)"
 - (2) Title and character of case
 - (3) Brief description of evidence enclosed
 - (4) Bureau and field office file numbers, if known
 - c. Staple to original letter of transmittal. Bulky evidence being submitted under separate cover should be enclosed in both an inner and an outer wrapper, with a copy of the letter of transmittal serving as an invoice attached to the outside of the inner wrapper.
3. Obtaining known handwriting samples
 - a. Obtain samples from dictation until believed normal writing has been produced. Number of samples necessary cannot be determined in advance. Sometimes two or more interviews necessary.
 - b. Do not allow suspect to see either original document in question or photograph thereof.
 - c. Remove each sample from sight of writer as soon as completed.
 - d. Do not give instructions on spelling, punctuation, arrangement, etc. If suggestions necessary to obtain type samples desired, Laboratory must be advised in detail.
 - e. Use same kind writing media, such as type and size of paper, writing instruments, printed forms (check forms, notes, etc.). If printed forms not available, cut ordinary paper to suitable size. Form FD-352 may be used for obtaining known specimens in check cases.
 - f. Obtain full text of questioned writing in word-for-word order at least once, if possible. Signatures and less extensive writing should be prepared several times, each time on different piece of paper. Obscene passages, proper nouns, etc., may be omitted from dictation.
 - g. In forgery cases, Laboratory should also be furnished with genuine signatures of person whose name is forged.
 - h. Obtain samples with both right and left hand.
 - i. Obtain samples written rapidly, slowly, and at different slants.
 - j. Obtain samples of supplementary writings, such as sketches, drawings, manner of addressing an envelope, etc.
 - k. Include a statement that samples being given voluntarily.
 - l. Witness each sample on back, never on front. Include name of the person from whom obtained, date, and name or initials of Agent.
 - m. If readily available, samples of undictated writing should also be obtained, such as applications for employment, social or business correspondence, school papers, etc.

4. Obtaining known typewriting samples
 - a. Use paper of about same size as questioned material.
 - b. Prepare an exact word-for-word copy of typewriting in question using as nearly as possible same degree of touch.
 - c. Also prepare at least a partial copy of typewriting in question using different degrees of touch, including heavy, medium, and light.
 - d. Pertinent information relative to make and model of typewriter, serial number, room in which located, date, Agent's name or initials, etc., should be typed at bottom of samples.
 - e. Examine the ribbon. If it is being used for the first time it should be forwarded to Laboratory for a determination of message thereon.
 - f. Obtain carbon samples of every character on keyboard, particularly if typewriter is in good mechanical condition. To do this, place ribbon mechanism in "stencil" position, insert a sheet of carbon paper over a sheet of ordinary paper, and allow keys to strike carbon paper directly.
5. Examinations from photographs, photostats, [or other photocopies]
 - a. Many types of examinations can be made only on original evidence, such as
 - (1) Most types of forgeries
 - (2) Many typewriting cases
 - (3) Checkwriter impressions, notary seals, etc.
 - b. Originals are needed for making court exhibits.
 - c. Photographs are usually preferable to photostats [or other photocopies.]
 - d. Routine check file searches can be made from [photocopies.]
 - e. If original evidence is not available, Laboratory should be furnished with best possible photographs. In no case should inability to forward originals constitute valid reason for not requesting Laboratory examination.
6. Conditions affecting results of document examinations
 - a. Disguise
 - (1) Ability varies with individual
 - (2) Definite conclusion often impossible
 - b. Limited questioned material
 - (1) Signature of average length usually sufficient questioned material
 - c. Borderline cases
 - (1) Definite conclusion impossible even though ample quantities of both questioned and known material available
 - (2) Conclusions based on relative strength of handwriting peculiarities rather than numerical basis
 - d. Inadequate known material
 - (1) Known handwriting, regardless of amount, often unsatisfactory unless similar letters or combinations of letters available for side-by-side comparison
 - (2) Hand printing not comparable with handwriting; upper-case hand printing not comparable with lower-case hand printing
 - e. Lack of contemporaneous standards (where long interval of time exists)
7. Handwriting testimony standing alone
 - a. Handwriting identifications should be but a part of total evidence developed.
 - b. Additional evidence of usual type desirable to supplement handwriting identification
 - c. Final decision on legal aspects this matter rests with USA

8. Files of questioned and known material
 - a. National fraudulent check file
 - (1) Major subdivisions
 - (a) Signature section, alphabetical
 - I. Contains photographs of all handwritten names in all cases
 - II. All checks searched
 - (b) Master section
 - I. Contains representative photographs of entire checks and photographs of check passers, such as "Regiscope," "Dubl-chek," or similar photographs from selected, outstanding cases, including master check cases
 - II. Searches made on all checks suitable for search
 - (c) [Deleted]
 - (2) Comparison of checks with signatures on fingerprint cards
 - (a) Need best possible description of subject to avoid handling needless numbers of fingerprint cards
 - (3) Checks not treated for latent fingerprints unless specifically requested by field
 - (4) Photocopies adequate for routine searches
 - b. Deleted
 - c. Anonymous letter file
 - (1) Consists of photographic copies of kidnap notes, extortion and threatening letters
 - (2) Letters of abusive or "crank" nature neither searched nor added unless unusual situation
 - d. National security file (This file is confidential.)
 - (1) Both known and questioned handwriting and typewriting in espionage and other security-type cases, including known writing of communist key figures
 - e. Deleted
 - f. Obscene matter file
 - (1) Consists of cartoons, booklets, photographs, phonograph records, motion-picture film, etc., of an obscene nature
 - g. Bank robbery note file
 - (1) Consists of photographic copies of writings of known robbers, of holdup notes found in the possession of known criminals, and of notes used in actual holdups or attempted holdups of banks and other establishments
 - (2) Notes and other writings found on counters or in wastebaskets in banks which are obviously the work of mischievous juveniles will be searched but will not be added unless unusual situation.

9. Reference files of known standards
 - a. Typewriter standards file
 - (1) Consists of original samples of typewriting from every available style of type made in this country and some foreign countries
 - (2) Permits classification of questioned typewriting on basis of make and model
 - b. Paper watermark records
 - (1) An index of watermarks and brands used by paper manufacturers
 - (2) Aids in tracing source or origin of paper
 - c. Checkwriter standards
 - (1) Collection of original checkwriter impressions
 - (2) Permits classification of questioned checkwriter impressions on basis of make and model
 - d. Safety paper collection
 - (1) Original samples of safety paper used for checks, etc.
 - (2) Aids in tracing manufacturer
 - e. Rubber stamp and printing collection
 - (1) Consists of facsimile impressions of different styles of type and rubber stamps
 - f. [Deleted]

- g. Ink standards collection
 - (1) A collection of commercial inks used for preparing test samples at regular intervals
- 10. Summary of types of document examinations
 - a. Handwriting
 - b. Hand printing or hand lettering
 - c. Forgeries
 - (1) Traced
 - (a) Try to locate pattern or master signature from which traced.
 - (b) Unable to determine who did tracing
 - (2) Copied
 - (3) Freehand
 - (a) Forger has no knowledge how genuine signature looks.
 - (4) Known handwriting samples should include
 - (a) Handwriting of suspect
 - (b) Signatures of person whose name allegedly forged, prepared at about same time as questioned
 - d. Typewriting
 - (1) New machines difficult to identify
 - e. Paper
 - (1) Definite identification seldom possible
 - (2) Give consideration to watermark, tool or knife marks along edges, whether torn in manner to leave stub in tablet.
 - f. Inks
 - (1) [Ordinary writing fluids and ball-point pen inks can be examined for dye composition.
 - (2) Printing inks and stamp pad inks usually cannot be identified definitely.]
 - g. Pencils, pens, etc.
 - (1) Pencils can be classified as to degree of hardness but cannot be identified.
 - (2) Pens cannot be identified.
 - h. The true age of a document
 - (1) May be based on watermark, letterhead or other printing, typewriting, and ink
 - (2) [Deleted]
 - i. Printing, lithographing, and other duplicating processes
 - j. Obliterated or eradicated writing
 - (1) Nonstaining methods
 - (a) Photography, including ultraviolet and infrared
 - (b) Microscopic
 - (2) Staining
 - (a) Advise whether methods producing minor stains may be applied.
 - k. Indented writing
 - (1) Do not fold or crease.
 - l. Used carbon paper
 - (1) Do not fold or crease.
 - m. Burned or charred paper
 - (1) Ship between layers of cotton.
 - n. Portrait parle examinations
 - (1) To determine whether two or more photographs were made of same person

E. BLOOD AND OTHER BODY FLUIDS

- 1. Blood as a clue
 - a. Bloodstains often constitute initial and only indication of crime.
 - b. Stains help locate crime scene.
 - c. Analysis of stains disproves or corroborates suspect's claim as to animal source.
 - d. Grouping of stains on clothing may eliminate suspect.
- 2. Analysis of blood
 - a. Appearance of blood quite variable. Visual identification unreliable. Several procedures necessary to positively identify and classify:
 - (1) Preliminary chemical test to differentiate from other stains
 - (2) Confirmatory test for positive identification

- (3) Precipitin test to determine animal or human origin
 - (4) Grouping tests of human blood
3. Brief description of tests
- a. Benzidine test - A preliminary test. Does not identify. Only indicates possible presence.
 - (1) Materials needed - Chemically pure benzidine, ethyl alcohol, [acetic acid,]normal saline, cotton swabs, and 3% hydrogen peroxide
 - (2) Mixing benzidine solution - About 1/16 teaspoon of benzidine[powder] in 2 ounces of alcohol[and add several drops of glacial acetic acid]
 - (3) Mixing normal saline - About one tablespoon salt per quart of water
 - (4) Procedure for making test - Rub cotton swab soaked in saline over edge of suspect stain until slight amount dissolves on swab. Add drop or two of benzidine solution to swab followed by drop or two of hydrogen peroxide. Immediate blue color indicates possibility of blood. Substance not blood if no immediate blue color appears.
 - (5) Precautions necessary to conclusive testing - Always use fresh benzidine solution. Always add solution to swabs, never to stain itself.
 - b. Confirmatory test for blood[(microchemical)]
 - (1) Hemochromogen crystal test - Characteristic pyridine hemo-chromogen crystals are formed when a small quantity of blood is treated with Takayama reagent.
 - (2) Deleted
 - c. Precipitin test for origin of blood[(Serological)]
 - (1) Based on interaction of blood proteins with immune antibodies in testing antiserum
 - (2) Positive test manifested by appearance of gray ring at junction of two liquids when saline extract of suspect blood is underlaid with[corresponding]antiserum in small test tube
 - d. Blood grouping
 - (1) Dried blood classifiable into four major groups - O, A, B, and AB (international nomenclature)
 - (2) Fresh liquid blood classifiable into thousands of types based on combinations of subfactors
 - (3) Minimum size of groupable bloodstain - fairly heavy stain measuring $\frac{1}{4}$ " by $\frac{1}{2}$ " in size
4. How to submit bloodstained items
- a. Necessary to dry stains before wrapping to avoid putrefaction
 - b. Dry by exposure to atmosphere in well-ventilated room.
 - c. In drying, avoid exposure to direct sunlight, artificial heat, or air-blast of a fan.
 - d. Wrap each item separately.
 - e. Small particles, such as fingernail scrapings, should be placed in [round]pill boxes sealed with tape.
 - f. In removing stained portions of objects for submission, include some adjacent unstained material for control test purposes.
 - g. Heavy specimens submitted in wooden boxes should be held in place securely by wooden cleats or heavy nails and wires.
5. Submission of liquid blood
- a. Samples from victims and suspects are recommended when available.
 - b. Precautions to be considered
 - (1) Submit to Laboratory as soon as possible after withdrawal of sample.
 - (2) Send separately, never in large box with other specimens coming by mail or express.
 - (3) Send registered airmail, special delivery.
 - (4) Use no refrigerants[but small amount of preservative and anti-coagulant recommended.]
 - (5) Wrap tube or vial in cotton and place in cylindrical mailing tube or appropriate-sized rigid box.
 - (6) Place tape over stopper to prevent slippage of stopper due to air pressure difference in transit.

6. Other body fluids
 - a. About 85% of people are secretors - people who have in their other body fluids, such as semen and saliva, same group factors as in blood.
 - b. Occasionally possible to group saliva on cigarette stubs or semen on fabrics
 - c. Conclusive groupings infrequent due to dirty cigarette stubs or to contamination of seminal stains by body fluids of victim
 - d. Saliva on cigar butts not groupable due to soluble interfering substances in tobacco leaf

F. EXPLOSIVES

1. Principal types
 - a. Black powder
 - (1) Actuated by flame or heat
 - (2) Transport and store in metal can or tight box. Keep away from fire or heat.
 - (3) Destroyed by immersion in water
 - b. Smokeless powder
 - (1) Transport and store in metal can or tight box. Keep away from fire or heat.
 - (2) Destroy by spreading out in long thin trail upon ground and ignite. Cannot be destroyed by immersion in water.
 - c. Dynamite and nitroglycerin
 - (1) Destroyed by burning in open and igniting with a piece of safety fuse or by a train of kerosene-soaked newspaper. Piece of fuse or newspaper soaked with kerosene should be sufficiently long to enable person igniting explosive to retire to safe distance or behind a barricade before flame reaches explosive.
 - (2) Transport from scene by wrapping in several thicknesses of newspaper in order that any nitroglycerin from cartridges may be absorbed. Destroy newspaper wrapping with dynamite.
 - (3) Avoid transporting nitroglycerin in liquid state. If necessary to transport, pour nitroglycerin on sawdust at point of recovery. This forms type of dynamite which may be more safely transported than liquid nitroglycerin. Destroy in same manner as suggested for dynamite.
 - (4) Dynamite and nitroglycerin will usually burn, however, there is always danger of explosion. Accordingly, all precautions (method of lighting and retiring to safe distance behind barricade) should be taken.
 - d. Blasting caps - Two types, those exploded by ignition with safety fuse and those exploded by electric current
 - (1) Extremely sensitive to blows and friction - HANDLE CAREFULLY.
 - (2) Fuse caps - Fragments of exploded cap rarely found at scene
 - (3) Electric blasting caps - Appreciable amount of case remains after explosion. May be submitted to Laboratory to determine manufacturer.
 - (4) Exploded fragments of blasting caps may be forwarded to Laboratory by registered mail.
 - (5) Blasting caps, when recovered, should be placed on cloth or similar cushioning material preventing them from coming in contact with one another and should be kept away from flame or heat when transported.
 - (6) Do not place electric blasting caps near radio transmitter since wires of cap may pick up sufficient electrical energy to detonate it.
 - (7) Destroy
 - (a) Bury in ground several inches below surface with closed end of tube down.
 - (b) Detonate with safety fuse or electric current as battery.
 - (c) Retire behind barricade at safe distance.
 - (d) Destroy caps individually.
2. Transmission of unexploded blasting caps and other explosive material to Laboratory
 - a. Specific Bureau authorization must first be obtained in each instance.
 - b. Bureau will advise proper method of packaging and shipping.

3. Bombs and infernal machines

Note - In view of almost infinite possible varieties of bombs, no set procedure can be established for handling all of them. However, certain steps, taking safety and property protection into due consideration, should be taken in practically all instances. Where bomb found and Bureau not primarily responsible in any way for such bomb, handling should be left entirely to local authorities. Neither by statements nor instructions should any responsibility be assumed, and though local authorities may request consultation of a Bureau representative as to safe method of handling situation, any suggestion should be general and should not direct action in particular situation.

a. Discovery of bomb or suspected bomb

- (1) Clear danger area of all occupants.
- (2) Establish an organized guard outside the danger area.
- (3) Shut off power, gas, and fuel lines leading into the danger area.
- (4) Remove inflammable materials from the surrounding area.
- (5) Notify local fire department and rescue squad.
- (6) Obtain services of a competent explosives expert.
- (7) Obtain mattresses and sandbags to be used for protection.
- (8) Check and have available fire-extinguishing equipment.
- (9) Arrange for use of portable X-ray equipment if deemed advisable by technical man.
- (10) Avoid moving any article which may be connected with bomb or act as a trigger mechanism.
- (11) Let expert dispose of bomb.

G. FIREARMS IDENTIFICATION

1. Transmittal of specimens

a. Identification of specimens

- (1) Bullets - Mark on base or nose.
- (2) Cartridge cases - Mark inside mouth or on outside near mouth of case.
- (3) Guns
 - (a) Serial number
 - (b) Tag attached to trigger guard
- (4) Articles of clothing, etc., submitted in connection with firearms evidence should be suitably tagged.

b. Wrapping and shipping

- (1) Each item should be wrapped separately and appropriately identified. Each bullet and cartridge case should be wrapped separately in cotton and placed in pillbox or other appropriate container to prevent mutilation of markings.
- (2) Unloaded firearms, bullets, and cartridge cases (not unfired ammunition) may be forwarded by registered mail provided package does not exceed maximum weight requirements and bears notation "Firearms, For Official Law Enforcement Agency, Official Shipment." [Word "Firearms" should be in letters one inch high.]
- (3) Live rounds of ammunition must be forwarded railway express or air express.
- (4) If necessary to submit a loaded firearm, package must be identified as containing a loaded firearm and shipment made by railway express or air express only.

2. Examinations

a. Bullet identification

- (1) Based on individual microscopic imperfections in gun barrels produced at time barrels manufactured, as well as those produced by corrosion, use, and wear
- (2) Bullets fired through gun barrel have such markings impressed on surface.
- (3) By comparing these markings on bullet surfaces, possible to determine whether two or more bullets fired from same weapon
- (4) Markings on bullets fall into two general classifications:
 - (a) General rifling characteristics
 - I. Number of lands and grooves
 - II. Direction of twist
 - III. Caliber
 - IV. Other associated specifications

SECTION 8. SCIENTIFIC AIDS IN CRIMINAL INVESTIGATIONS

- (b) Individual characteristics - those markings on a bullet which permit its identification as having been fired from a particular weapon
- b. Cartridge cases
 - (1) Same basic principles apply to mechanism of guns
 - (2) Firing pin, breech face, extractor and ejector leave markings on cartridge cases which permit their identification as having been fired from a particular weapon.
- c. Conclusions
 - (1) Identification. Bullet or cartridge case identified as fired from particular weapon.
 - (2) Nonidentification. Bullet or cartridge case not fired from a particular weapon.
 - (3) No conclusion. Not possible to determine whether a particular bullet or cartridge case fired from a particular weapon.
- 3. Related examinations
 - a. Powder pattern tests
 - (1) Powder pattern, observed microscopically and developed chemically, around bullet entrance hole may indicate distance at which shot fired.
 - (2) Because particles may be adhering loosely to garment, extreme care must be taken in handling and wrapping clothing.
 - (3) Examination of hole in skin for powder residue best made by medical examiner in field
 - (4) Generally speaking, powder patterns may be developed when a weapon is fired at a distance of 3 feet or less.
 - b. Shot pattern
 - (1) Indication of distance may be determined by spread or size of pattern shot.
 - (2) In firing tests for comparison, desirable to use suspect weapon and same type of ammunition
 - c. Paraffin test
 - (1) Hand of suspect coated with warm paraffin
 - (2) Paraffin removed from hand and treated for presence of nitrates present in gunpowder to indicate whether subject recently fired gun
 - (3) Test not specific for gunpowder
 - (4) Not recommended for other than investigative procedure
 - d. Numbers restoration
 - (1) Restoration of obliterated serial numbers and other obliterated markings on guns when specifically requested
 - e. Examination for mechanical operation
 - (1) Is weapon functioning properly
 - (2) Determine weight of trigger pull
 - (3) Other related examinations
 - (4) Requests for such examinations should be specific.
 - f. Fingerprint examinations
 - (1) Place firearms in cellophane envelope and mark envelope "latent."
- 4. Reference collections
 - a. Reference collection of firearms
 - (1) For study, test and comparison purposes
 - (2) Includes both American and foreign weapons
 - b. Standard ammunition file
 - (1) Contains American and foreign ammunition
 - (2) Used to identify evidence as to caliber, type and manufacturer
 - c. Rifling specifications file
 - (1) Rifling specifications and other important measurements utilized in manufacture of modern weapons
 - d. [Open case ammunition file (OCAF)]
 - (1) Contains bullets and cartridge cases recovered at scenes of various unsolved crimes throughout country
 - (2) Addition of specimens to this file limited to cases of major importance [investigated by FBI]
 - (3) Upon specific request, bullets fired from weapons submitted to Laboratory will be compared with file.

[5. [Deleted]

H. GLASS FRACTURES

1. Examination of holes in glass made by blunt instruments and bullets
2. Bullet holes in glass
 - a. Cone-shaped holes, exit side larger in diameter than entrance side
 - b. May be possible by firing tests to determine type of ammunition used
3. Holes caused by blunt instruments
 - a. Determine direction of blow through examination of radial cracks (cracks emanating from point of impact) and concentric cracks (cracks that extend from radial to radial crack)
4. Headlight lenses
 - a. Determine type of lens from fragments of glass found at scene of hit-and-run accident
 - b. Possibility of determining make of car from lens fragments remote due to exclusive use and interchangeability of sealed beam headlamp units

I. HAIRS, FIBERS, AND FABRICS

1. Hair
 - a. Human
 - (1) Caucasoid (white)
 - (2) Negroid
 - (3) Mongoloid (including Eskimo and Indian)
 - b. Animal
 - (1) Kind of animal, such as a dog, cat, hog, deer, cow, etc.
 - c. Limitations
 - (1) Positive identifications cannot be made.
 - (2) If two samples are found to be similar, they could have come from same source.
 - (3) If two samples are found to be dissimilar, they could not have come from the same source.
2. Fibers and fabrics
 - a. Classifications of fibers
 - (1) Plant
 - (2) Animal
 - (3) Synthetic
 - b. Fabrics
 - (1) Woven
 - (2) Knitted
 - (3) Felted
 - (4) Type of fiber, manner of weave, pattern, and dye enter into examination of fabrics
3. Invisible laundry marks
 - a. Laboratory has file of invisible insignia assigned to many laundries.
 - b. Invisible laundry mark usually consists of insignia followed by numbers and/or letters.
 - c. Mark is visible only under ultraviolet light.
 - d. Laboratory does not have file of visible laundry marks. For these, inquiry at local laundries may be helpful.

J. METALLURGICAL EXAMINATIONS

1. Metal identification
 - a. Examinations possible
 - (1) Determine positively if two pieces of metal were at one time a single piece
 - (2) Identify kind and composition
 - (3) Determine use
 - (4) Determine if both pieces could have come from one piece

2. Restoration of numbers on metal
 - a. Stamping of number in metal causes deformation in metal structure deeper than actual number.
 - b. Agents should not attempt restoration on evidence for other agencies.
 - c. For methods available to Agents in field, see section P.

K. PAINTS, DYES AND STAINS

1. Automobile paints
 - a. National automobile paint file contains paint panels representing paints used on all makes of American cars.
 - b. Possible to establish year and make of automobile from which a chip came
 - c. Very careful search of accident scene should be made to locate small chips.
 - d. Paint fragments often found in clothing of hit-and-run victim.
 - e. Paints may be transferred from one car to another or from car to object or object to car during accident.
2. Paints other than automobile paints
 - a. On safes, vaults, window sills, door frames, etc., may be transferred to tools used to open them
3. Dyes and stains
 - a. Dyes in questioned and known samples of cloth
 - b. Grass stains
 - c. Coffee stains
 - d. Lipstick
 - e. Shoe polish

L. PHARMACEUTICALS

1. Analysis difficult. Submit entire sample.
2. Ascertain from subject or witness what he knows about sample.
3. Submit sample in original container, if possible.
4. If prescription number available, contact pharmacist (if local) and obtain his comments.
5. Possession of certain materials may be illegal.
 - a. Heroin
 - b. Marijuana
 - c. Morphine and other drugs without prescription
6. Possession of pharmaceuticals for illegal purposes
 - a. As stimulants to avoid military service
 - b. As secret writing materials
 - c. As "knock-out drops"
 - d. As poisons

M. SOILS AND OTHER MINERAL SUBSTANCES

1. Soils
 - a. Assist in placing subject at crime scene
 - b. Representative samples from crime scene must be submitted. Ideal container is cylindrical ice cream carton.
2. Safe insulations
 - a. Safes from different manufacturers often contain different fire insulation materials.
 - b. May be found on subject's clothing, shoes, tools
 - c. Submit known sample; when available.
3. Other mineral substances
 - a. Abrasives
 - b. Plaster
 - c. Glass fragments
 - d. Ceramics
 - e. Occupational dust
 - f. Ores
 - g. Brick
 - h. Concrete, others

N. TOOLMARKS

1. Similar to firearms examination
2. Hammer, chisel, punch, screwdriver, prybar marks on safe parts
3. Jimmy marks in wood or metal
4. Pliers and wrench marks

O. TOXICOLOGICAL EXAMINATIONS

1. Purpose
Assist in determining cause of death in suspected poisoning cases
2. Types of poison
 - a. Gases, such as carbon monoxide
 - b. Metals, such as arsenic, antimony, etc.
 - c. Volatile, such as alcohols, cyanides, etc.
 - d. Barbiturates (sleeping pills)
 - e. Alkaloids, including strychnine, morphine, and other plant poisons
 - f. Many other poisons not included in above classifications
3. Information necessary to conduct complete toxicological examination
 - a. Copy of autopsy report
 - b. Treatment and drugs administered to victim
 - c. Symptoms exhibited prior to death
 - d. Any information developed during investigation indicating type of poison involved
4. Organs and body fluids necessary to make complete examination
 - a. Brain (one-half)
 - b. Kidney
 - c. Liver (large section)
 - d. Urine (all available)
 - e. Blood (one pint)
 - f. Stomach and contents
 - g. Portion of intestine
 - h. Heart
 - i. Samples embalming fluids used if body embalmed
5. Preparation for shipment to Laboratory
 - a. Place all organs and fluids in separate containers.
 - b. Identify each container properly.
 - c. Place dry ice around containers (but not touching) and transmit by quickest practical method.
 - d. Mark package "keep cool."

P. FIELD AIDS

1. Recording crime scenes
 - a. Record evidence which shows disarrangement of objects at scene of crime by action which took place for later re-enactment. If disarrangement caused by action no longer exists, depend upon others for details of disturbance and for assistance in reproducing effects.
 - b. Notes
 - (1) Prepare complete notes.
 - (2) Meticulously record everything which may later be of importance.
 - (a) Dimensions of furniture
 - (b) Distances from objects to entrances and exits
 - (c) Dimensions of entrances and exits
 - (d) Distances between objects
 - (e) Measurements showing exact location of stains and other evidence
 - (3) Record condition in which objects are found.
 - (4) Record contrast between normal appearance or condition of objects and condition after crime.
 - (5) If more than one investigator used for recording crime scene, divide work so each confines himself to his particular assignment.

c. Drawings

- (1) Make drawings to further show location of various objects. Graph paper may be used.
- (2) Prepare rough sketch(es) drawn to scale and containing necessary detailed measurements that could be forwarded to the Exhibits Section of the Administrative Division to be reproduced in a manner suitable for admittance in evidence by your testimony if necessary. Bear in mind that, in the event of need, your sketch(es) can be reproduced in finished form by the Exhibits Section and returned to you, along with your original sketch, for use as investigative aids or for pretrial and courtroom use. By allowing the Exhibits Section ample time to prepare chart work and return it to you, it is possible for you to check the finished material and request revisions made necessary by development of new information. Always allow as much time as possible for completion of requested work. In major cases in which such aids are absolutely necessary, three-dimensional models can be developed by the Exhibits Section for trial use. However, the field shall[not,]under[any]circumstances,[make any commitments regarding]model preparation[to]the USA's office without first obtaining Bureau approval. [This restriction is necessary]since model work requires that an exhibits specialist make on-the-spot observations, measurements, photographs, etc., so that he can authenticate the model by his testimony for the purpose of having it admitted in evidence.
- (3) Drawings must be accurate but need not follow rules of drawing.
- (4) Accurate measuring devices must be available and used.
- (5) Some cases require special drawings and charts for depicting particular phases or other especially significant data.
 - (a) Sometimes advantageous to have charts summarizing entries in record books and ledgers over a given period of time so course of certain transactions made at one time may be compared with those made at another time

SECTION 8. SCIENTIFIC AIDS IN CRIMINAL INVESTIGATIONS

- (b) Diagrams illustrating path of a projectile from one building to another
- (c) The line of vision from one point to another past obstructions
- d. Shoe and tire tread evidence
 - (1) Shoe print and tire tread evidence found at scene of crime provides important evidence for investigation and eventual prosecution of cases.
 - (2) Preserving the evidence. Original impression is most valuable and in some instances can be retained, such as a dust print on a piece of paper.
 - (3) Photographing
 - (a) All shoe and tire impressions should be photographed before other steps are taken to preserve original impressions. Photograph, however, limited to reproducing evidence in two dimensions.
 - (b) Camera should be placed directly above and parallel with impression.
 - (c) Each photograph should be properly identified and should include in photographed area a measuring rule to facilitate subsequent enlargement to exact size of original.
 - (d) Direct light from one side to cast shadows and produce photograph with 3-dimensional effect. Exposure usually made by open flash method with flash gun held to one side.
 - (e) Several photographs of each impression may be made, varying direction of light with each exposure.
 - (4) Impressions on firm surfaces. Floors, broken glass, desk tops, chairs, window sills, paper, etc., often bear dust impressions which are not visible except on close search with a portable light directed almost parallel with surface. Imperative crime scene be kept clear until such a search can be made. Impressions found on material which can be removed from crime scene should be properly identified and forwarded to Laboratory. Such original evidence should be fastened by tying, nailing or stapling to bottom of box, allowing nothing to come in direct contact with impressions. Impressions on floors and other hard surfaces which cannot be transmitted should first be photographed and then removed by use of fingerprint-lifting tape or similar technique.
 - (5) Plaster casting
 - (a) Three-dimensional impressions, such as shoe and tire impressions, should be reproduced by casting. To avoid errors, practice casts should be made before attempting to cast actual evidence.
 - (b) Preparation of impression
 - I. Loose materials, such as leaves or twigs, should be removed carefully.
 - II. Form a retaining wall around impression to retain casting material by using metal strips or similar materials.
 - III. Tire impressions should be reproduced in sections, obtaining full circumference of tires, if possible.

	PREPARATION OF IMPRESSION BEFORE CASTING
(c) IMPRESSION MEDIUMS	
Snow	Spray with plastic spray or sift with talcum powder to insulate snow from heat of setting plaster.
Sand and light soil	Use very thin mixture of plaster, and, if necessary, spray impression before casting with plastic spray or a similar fixative to strengthen surface. Caution: Do not allow force of spray to disturb impression.
Mud and water	Drain water from impression if possible. If a small amount of water remains, sift a thin layer of dry plaster directly into impression before pouring plaster mixture.

Solid earth A fine oil spray may assist in the removal of dirt from finished cast.

- (d) Materials for casting
- I. Plaster of paris, Hydrocal, Setstone, Castone, or similar casting material
 - II. Containers for mixing
 - III. Paddle or spoon for stirring
 - IV. Sufficient water
 - V. Reinforcement materials
- (e) Mixing and pouring
- I. Sift plaster into water, approximately four pounds of plaster to one quart of water or two to one by volume, stirring continuously until mixture reaches consistency of thick cream or pancake batter. Another method of mixing is to sift dry plaster into water without stirring until water will no longer absorb any plaster and dry plaster accumulates on surface. Mixture is then stirred just prior to pouring.
 - (A) Watery mixtures of plaster set slowly and sometimes damage impression by dissolving the soil.
 - (B) Thick mixtures harden rapidly and generally do not produce a good cast.
 - (C) To speed up hardening process a tablespoon of salt can be added to mixture.
 - (D) A small amount of citric acid, acetic acid, or sugar will retard hardening.
 - II. When desired consistency attained, pour plaster quickly, making certain to cover entire surface of impression with first application.
 - III. Thickness of cast will depend upon overall size, but regardless of size, cast should be reinforced to prevent breaking. After approximately $\frac{1}{2}$ -inch plaster has been poured, place sticks, wire mesh, or similar substance gently on plaster and then pour remaining plaster over these reinforcements.
 - IV. Before cast has completely hardened, Agent's initials, date, and any other data necessary for identification purposes should be scratched on back surface of cast.
 - V. Cast will harden sufficiently to remove in approximately 20 to 30 minutes. If cast feels warm it is still in process of setting and should not be removed from ground.
- (f) Cleaning the cast
- I. Do not attempt to clean cast until plaster is fully cured and dry.
 - II. Remove loose dirt carefully.
 - III. Cast can be washed with low pressure stream of water, but do not wash unless absolutely necessary.
 - IV. Usually desirable to give Laboratory the responsibility of final cleaning
- (g) Shipping casts. Should be shipped in a firm box cushioned inside with large amounts of excelsior, crumpled newspapers, or similar packing material.
- (6) Laboratory examinations
- (a) The cast, photograph, lift, or original impression should be transmitted to the Laboratory for investigative leads or comparison with suspected shoes and tires.
 - (b) Shoe print and tire tread files. Evidence will be compared with shoe print and tire tread files to determine manufacturer, design, size, etc., of original shoe or tire.
 - I. Shoe print file consists of photographs and related information of all [available] current rubber and composition heel and sole designs manufactured in U. S.
 - II. Tire tread file contains blueprints and photographs of new and retread tire designs.

III. Comparisons with known evidence. Characteristic marks will in many cases enable Laboratory to identify positively a shoe or tire with questioned impression.

- (7) Moulage materials commonly used in law enforcement to make death masks, molds of wounds, perishable foods, exhibits, etc. Moulage reproductions of 3-dimensional impressions, such as tooth marks, etc., are normally made in Laboratory.

e. Photography

- (1) Recording crime scenes and related assignments

Crime scene will not long remain undisturbed and should be photographed as soon as possible, preferably before anyone is allowed to go into area.

- (a) Distant photographs should be made to show location of scene within the area. Include permanent landmarks for recording locality.
- (b) Make several photographs showing relative positions and conditions of objects within the area, such as shoe prints, cartridge cases, fingerprints, etc. Use proper camera angles to record relative distances and positions accurately. Such photographs valuable as evidence in court, for refreshing witness's memory, and interrogating suspects and witnesses.
- (c) Close-up photographs of evidence that cannot be removed from scene should be made, such as impressions of tires, shoes, fingerprints, etc., so such photographs can be used for laboratory examinations. Photographs must show impressions or markings in detail and include a scale, Agent's initials, and date.
- [(d) Interior crime scenes should be carefully and accurately recorded in photographs. A wide angle lens will be particularly helpful in much of this photography. In situations involving interior crime scenes, the exterior surroundings should also be photographed.]

- (2) [Deleted]
- (3) [Deleted]
- (4) [Deleted]

Solid earth A fine oil spray may assist in the removal of dirt from finished cast.

- (d) Materials for casting
- I. Plaster of paris, Hydrocal, Setstone, Castone, or similar casting material
 - II. Containers for mixing
 - III. Paddle or spoon for stirring
 - IV. Sufficient water
 - V. Reinforcement materials
- (e) Mixing and pouring
- I. Sift plaster into water, approximately four pounds of plaster to one quart of water or two to one by volume, stirring continuously until mixture reaches consistency of thick cream or pancake batter. Another method of mixing is to sift dry plaster into water without stirring until water will no longer absorb any plaster and dry plaster accumulates on surface. Mixture is then stirred just prior to pouring.
 - (A) Watery mixtures of plaster set slowly and sometimes damage impression by dissolving the soil.
 - (B) Thick mixtures harden rapidly and generally do not produce a good cast.
 - (C) To speed up hardening process a tablespoon of salt can be added to mixture.
 - (D) A small amount of citric acid, acetic acid, or sugar will retard hardening.
 - II. When desired consistency attained, pour plaster quickly, making certain to cover entire surface of impression with first application.
 - III. Thickness of cast will depend upon overall size, but regardless of size, cast should be reinforced to prevent breaking. After approximately $\frac{1}{2}$ -inch plaster has been poured, place sticks, wire mesh, or similar substance gently on plaster and then pour remaining plaster over these reinforcements.
 - IV. Before cast has completely hardened, Agent's initials, date, and any other data necessary for identification purposes should be scratched on back surface of cast.
 - V. Cast will harden sufficiently to remove in approximately 20 to 30 minutes. If cast feels warm it is still in process of setting and should not be removed from ground.
- (f) Cleaning the cast
- I. Do not attempt to clean cast until plaster is fully cured and dry.
 - II. Remove loose dirt carefully.
 - III. Cast can be washed with low pressure stream of water, but do not wash unless absolutely necessary.
 - IV. Usually desirable to give Laboratory the responsibility of final cleaning
- (g) Shipping casts. Should be shipped in a firm box cushioned inside with large amounts of excelsior, crumpled newspapers, or similar packing material.
- (6) Laboratory examinations
- (a) The cast, photograph, lift, or original impression should be transmitted to the Laboratory for investigative leads or comparison with suspected shoes and tires.
 - (b) Shoe print and tire tread files. Evidence will be compared with shoe print and tire tread files to determine manufacturer, design, size, etc., of original shoe or tire.
 - I. Shoe print file consists of photographs and related information of all [available] current rubber and composition heel and sole designs manufactured in U. S.
 - II. Tire tread file contains blueprints and photographs of new and retread tire designs.

2. [Photography

a. Equipment for general purpose photography available to all offices

<u>Name of equipment</u>	<u>Description</u>	<u>Use</u>
Speed Graphic camera	Press-type 4" by 5" camera with range finder and ground glass focusing. Units include carrying case, flash attachment, and tripod.	General crime scene, "mug," document, and related photography. Bureau's general purpose still camera. Before using range finder, check accuracy against ground glass and check shutter by determining whether consistent at a set speed. Test flash gun before use - replace batteries if shutter not synchronized with flash.
Finger-print camera	Fixed focus camera with self-contained lights. Uses 2 $\frac{1}{4}$ " by 3 $\frac{1}{4}$ " film packs.	Actual size photographs of fingerprints. Also small sections of documents - NOT to be used if more than one exposure required to cover section of document needed.
Leica camera	A 35 mm. camera. Uses 36 exposure loads. Accessories with some units include flash, copy stand, and telephoto lens - 127 mm. or 135 mm.	A supplement to Speed Graphic camera for general use where large volume of exposures required. Should not be used for close-up exposures of impressions, fingerprints, etc.
Bell & Howell Model 70DA camera	A 16 mm. motion-picture camera. Takes 100 ft. rolls providing 4 minutes running time at normal speed of 16 frames per second. Units include normal 1" lens, 3", and 6" telephoto lenses, exposure meter, and carrying case.	Record action during surveillance, extortion, payoff, commission of crime, etc. Should NOT be used in lieu of still camera for surveillance photography since quality enlargements cannot ordinarily be made from individual movie frames.

SECTION 8. SCIENTIFIC AIDS IN CRIMINAL INVESTIGATIONS

b. Microfilming equipment

<u>Name of equipment</u>	<u>Description</u>	<u>Use</u>
Photo-record	Suitcase 27" by 21" by 10" containing fixed focus Photo-record camera, mounted lights, and shutter release - film advance foot treadle which is ready to operate when case is opened. Weighs 40 lbs. Uses 100' rolls Microfile or comparable film producing maximum of 750 exposures per load. Older units must be assembled and manually focused.	Rapid photography of large number of documents including bound documents to 2" thickness. Allow 3½' of film (25-30 exposures) at beginning and end of each roll for leader and trailer. Remove black magazine slide before exposure. Exposure time for Microfile film with two 100-watt bulbs is ¼ second at f.16.
Attache photocopy units	Portable, completely self-contained, collapsible document copy equipment carried in an attache case, 18" by 12" by 4 ¾", weighing 16 lbs. Electron photoflash lights powered by self-contained 90-volt battery. Camera is standard 36 exposure 35 mm. Minolta SR-1 with a 35 mm. f.4 Rokkor lens.	Rapid photography of small number of documents including bound and large size documents
Recordak Portable Microfilmer Model RP	A flow-type microfilmer in case 21" by 13" by 7". Has removable film unit into which two 100' rolls 16 mm. film can be loaded for duplicate record if desired.	Extremely rapid photography of unbound documents. Use Recordak Fine Grain Panchromatic 16 mm. film #1120 or film of comparable speed without opaque backing.
[Koni-Omega HK35 Microfilmer	A 26-pound 35 mm. portable planetary camera which operates on 110 volts. Self-contained lights, easily focused either by tape or eyesight, with film advance and shutter cocking controlled automatically.	Rapid photography of bound or large size single page documents. Use 100-foot roll of nonperforated, antihalation Recordak #1633 film.]

c. Document copying equipment

<u>Name of equipment</u>	<u>Description</u>	<u>Use</u>
Speed Graphic units	Speed Graphic camera in carrying case with light bracket. Camera and bracket are mounted to case. Camera can also be used on tripod with two gooseneck lamps each 15" from document for this purpose.	Document photography and accurate record shots of items of evidence, including impressions, fingerprints, etc. This is equipment to use for accurate detailed photographs of documents and other evidence. Exposure for copying documents with Eastman Tri-X film is 1/10 second at f.16.
Xerox	Stationary document copy equipment employing a dry (electrostatic) process and providing for the reproduction of multiple copies	To provide single or multiple copies of documents. Of particular value where large quantities of documents are involved. Excellent quality copies can be made of practically all kinds of documents.
	For volume reproduction of documentary material from 16 or 35 mm. negatives, forward film to the Mechanical Section which has a Xerox Copyflo printer. This printer can reproduce about 20 prints per minute, up to 11 inches wide.	
Kalvar Multimode Reproducer (microfilm copying machine)	This piece of equipment, available in the Mechanical Section, copies either positive or negative, 16 and 35 mm. roll film. No darkroom or chemicals required. Unit weighs about 150 pounds and utilizes regular 110 voltage for power. Ideal for reproducing large volume of 16 or 35 mm. roll film to negative or positive film.	

d. Surveillance photography

The objective of surveillance photography is to make recognizable photographs of individuals or activities under investigation without the knowledge of the participants. Still photographs should be made if the purpose is to obtain identifiable photographs of individuals and motion pictures should be made if the purpose is to record the activity. Motion pictures cannot be substituted for stills since it is not possible to make high quality enlargements of good definition from the individual frames of movie film.

(1) Long range photography with telephoto equipment

Lens used depends upon the distance from the cover available to the subject.

- (a) Telephoto lenses are available for still photography at distances up to 1000':

<u>Distance range</u>	<u>Lens focal length</u>
50' - 150'	6", 150 mm.; 7", 180 mm.; and 8", 200 mm.
150' - 300'	10", 254 mm.; 10½", 270 mm.; 12", 300 mm.; 16", 400 mm.; 20", 500 mm.
300' - 600'	40", 1000 mm.
600' - 1000'	80", 2000 mm.

- (b) Fast telephoto lenses are available for photography in situations in which the intensity of the light available is low. These are limited to the shorter 6" or 7" telephoto lenses, but 8", 12", and 16" lenses, which are comparatively fast, are also available.
- (c) Telephoto 3" and 6" lenses are available in every field office for the motion-picture camera. Longer lenses including some fast lenses for motion-picture photography at low light levels are available on request from the FBI Laboratory.

(2) Close range photography with concealed cameras

- (a) Motor-operated cameras, such as the Robot 35 mm. cameras with self-contained spring motors, are available. Concealments available for these cameras include brief case, shaving kit, lunch pail, tie clasp, and others.
- (b) Motion-picture cameras including some electric-eye or automatic shutter control cameras can be adapted for operation from concealments.
- (c) Camera equipment is available which is readily adaptable for use from cover in mobile equipment - automobiles, panel trucks, etc. Reflex (through the lens) focusing cameras are particularly useful for this application.

(3) Special problems

- (a) Remote control camera equipment, still and motion-picture, is available for unmanned surveillances and camera traps. Such equipment can be operated by direct wire connection or by radio signal from a distance. The cameras available for these installations are motor driven either with self-contained or accessory mechanical or electric motors. A variety of lenses can be used with the remote control camera equipment to provide coverage at a variety of distances.

- (b) [Ultrahigh-speed films for surveillance photography in low light level situations, such as a dimly lighted street or entry way at night, are available. The use of such films with available fast lenses extend surveillance photography to many nighttime and other situations where the available light is extremely low. Film, equipment, and assistance for these applications can be obtained from the FBI Laboratory.]
- (c) Infrared flash or flood photography can be used to obtain photographs in total darkness. High speed infrared film, infrared flashbulbs, and infrared filters for flood sources are available for such installations.

e. Miscellaneous

- (1) Personal identification (mug) photographs should include head and shoulders in full face view and profile. If not otherwise equipped, use Speed Graphic camera with flash equipment or flood lamps and, if available, a white background. Include identifying data in picture.
- (2) Polaroid cameras and 4" by 5" (Speed Graphic) Polaroid film holders are available in many offices. Bureau policy is to limit use of Polaroid to situations in which immediate photographic print will definitely further investigation. In other situations conventional photography should be used.
- (3) Color photography
The use of color photography should be considered during the course of all investigations where a record of the color or color contrast may be a factor in the evaluation of the evidence. Color photographs may be particularly helpful and important in recording the blood stains in a crime scene, the bruises on a human being, etc. When color photographs are to be made, Ektacolor Type S 4" x 5" sheet film should be used. Closely follow the instructions provided with the film as to lighting and exposure data. Good quality color prints or projection slides can be made from a color negative. If only projection slides are desired, color reversal (positive) film, such as Kodachrome, Ektachrome, or Anscochrome, can be used. [Whenever possible, Ektachrome film should be utilized for this is the one transparency film the Bureau can process. The others must be done commercially.]

f. Photographic problems

Bureau assistance should be requested with any unusual photographic problem or any photographic matter that cannot be resolved locally.

- (1) Standard photographic equipment, repairs, and routine film processing are the responsibility of the Mechanical Section of the Administrative Division. Correspondence relating to any problems with standard equipment, repairs, or processing should be marked for the attention of the Mechanical Section.
- (2) Surveillance photographic equipment, nonroutine photographic matters, and unusual processing problems in photography are the responsibility of the FBI Laboratory. Correspondence relating to such matters should be marked for the attention of the FBI Laboratory.
- (3) Requests for examinations of photographic evidence recovered in investigations should be marked for the attention of the FBI Laboratory.
- (4) The field should be continuously alert to bring to the Bureau's attention new photographic techniques, equipment, and procedures developed by Agents or brought to their attention.

3. The benzidine test for blood as a preliminary examination. See section 8E.
4. Number restoration
 - a. Etching method
 - (1) Applicable to steel only
 - (2) Solution contains 48 cc concentrated hydrochloric acid, 48 cc water and 4 grams cupric ammonium chloride
 - (3) Polish surface smooth and shiny.
 - (4) Make dam around area with paraffin or other wax.
 - (5) Constantly rub area with cotton swab wet with etching solution.
 - (6) Observe constantly. Process may require many hours.
 - (7) For metals other than steel, communicate with Laboratory.
 - b. Heat method
 - (1) Used only on cast iron
 - (2) Considerable experience usually required
 - (3) Polished surface and adjacent areas are slowly heated with acetylene torch.
 - (4) Discontinue heating after maintaining serial number area at faint red color for 1 or 2 minutes.
 - (5) Slowly cool.
 - (6) Lightly sand over serial number area to make restoration visible.
 - (7) Heat may crack or damage evidence.
 - c. Magnetic particle method
 - (1) Used in Laboratory. Not applicable in field.
 - d. Electrolytic method
 - (1) Used in Laboratory. Not applicable in field.
5. Dyestuffs, fluorescent powders and other materials
 - a. On decoy packages, cash boxes, money, etc.
 - (1) Purpose is to prepare object in order that a detectable trace will be left on person or property of person who handled same
 - (2) Choice of dye, powder or chemical depends on factors inherent with each situation.
 - (3) Material used can be dry powder, grease or liquid, and can be supplied in many visible and fluorescent colors.
 - (4) Dyes and chemicals require no supplemental equipment.
 - (5) Fluorescent powders require source of ultraviolet light to examine subject's hands or clothing.
 - b. Dyestuffs - malachite green and methylene blue
 - (1) Dyes have disadvantage of becoming visible to subject after contact with normal perspiration.
 - (2) Can be easily procured from drugstores, chemical supply houses or commercial and school laboratories
 - (3) Must be finely ground or powdered
 - (4) Are water soluble and can be washed off
 - (5) Do not use dye, such as methyl violet, since it finds common usage in carbon papers, indelible pencils, etc., which objects may provide an alibi.
 - c. Chemical dusting powder - silver nitrate
 - (1) Has disadvantage of becoming visible to subject
 - (2) Has disadvantage of not being immediately visible to Agent until exposed to light for several minutes
 - (3) Can be procured from drugstores, chemical supply houses or commercial and school laboratories
 - (4) Must be finely divided or powdered
 - (5) Produces a brown stain on tissue in presence of ordinary light
 - (6) Brown stains cannot be washed off.
 - d. Dyestuffs and silver nitrate
 - (1) Frequently advisable to use a mixture, such as a 50-50 mixture of powdered malachite green and silver nitrate. Malachite green will be immediately visible but can be subsequently washed off. Silver nitrate which may not be immediately visible cannot be washed off.
 - e. Fluorescent materials
 - (1) Have advantage of not being visible to subject

SECTION 8: SCIENTIFIC AIDS IN CRIMINAL INVESTIGATIONS

- (2) Have advantage of being subsequently identified as same unique powder used, by analysis of deposits on clothing, etc.
- (3) Have disadvantage of not being readily available
- (4) Have disadvantage of requiring a source of ultraviolet light
- (5) Phosphorescent materials are different from fluorescent powders and must not be used since these may be detected by subject even without an ultraviolet source.
- (6) Must be applied in a finely divided or powdered form
- (7) Choice of form depends on object to be marked, for example:
 - (a) Contact areas of tools can be coated with a grease, such as vaseline, mixed with a fluorescent powder without creating suspicion. Richer deposits are transferred when a grease film is used.
 - (b) Normally dry surfaces, such as gloves, money, doorknobs, steering wheels, etc., would arouse suspicion if coated with a grease. After coating an appropriate surface with grease the remainder of object and/or container may be dusted with dry powder.
 - (c) Time, amount of light, and other factors may limit application to dusting since dusting procedure is rapid and does not require meticulous attention.
 - (d) Liquid fluorescent materials normally used as a writing medium. Care must be taken to prevent liquid marks or discolorations on paper or surface treated.
- (8) Suppliers of ultraviolet fluorescent chemicals
 - (a) Switzer Brothers, Inc.
4732 St. Clair Avenue
Cleveland, Ohio [44103]
 - (b) New Jersey Zinc Co. of Pennsylvania
Technical Department
Palmerton, Pennsylvania [18071]
 - (c) Lawter Chemicals, Inc.
3550 [West] Touhy Avenue
Chicago, Illinois [60645]
 - (d) Burton Manufacturing Company
[Northridge, California * 91324]
 - (e) [Ultra-Violet Products, Inc.
5114 Walnut Grove
San Gabriel, California 91776]
 - (f) The National Marking Machine Company
[4026 Cherry Street]
Cincinnati, Ohio [45223]
- (9) Procedures for application
 - (a) In applying grease use bare fingers and rub over surfaces of items to be marked so as to leave a thin film. Avoid large "globs" of grease.
 - (b) In applying powder form, numerous methods are commonly used, such as shaking powder over items, dusting with a powder puff or pad of cheesecloth, or brushing over surfaces in a manner similar to that used to dust with fingerprint powder.
 - (c) Liquids can be applied with a clean pen or small paint brush.

Q. RADIO ENGINEERING SECTION

1. Field FM radio matters

a. Facilities

An FM radio station is installed in each field division headquarters city to provide voice communication between the field division office and Agents operating two-way radio cars in the [division.] FM radio stations are also provided in [most] resident agency cities. FM two-way radio cars are provided each field division for car-to-car and car-to-station voice communication. Portable FM radio equipment is furnished each field division to provide voice communication from the person or from temporary fixed locations to the FM radio stations and/or FM two-way radio cars.

b. Utilization

The field office FM radio stations are used each working day for routine communications matters, as well as for any special investigative situations which arise. The resident agency FM radio stations are used whenever required by investigative operations and are to be turned "on" whenever an Agent is in the office. Agents are required to have automobile two-way radios "on" whenever they are [in the vehicle.] They should make full use of two-way radio cars and radio station facilities to obtain increased investigative efficiency, as well as reduced communications costs. Portable equipment should be utilized as necessary in individual investigative situations.

c. Identification

- (1) Listed below are official field office FM radio station call signs and car prefixes for each field division. Call signs used by cars are composed of either (a) the appropriate prefix followed by a number arbitrarily assigned to the car by the field office or (b) the permanent number assigned the car by the Bureau without any prefix. The car prefixes are identical to office teletype designations. They are used to avoid confusion with the arbitrarily numbered cars of other field offices.

OFFICE	CALL	CAR PREFIX
ALBANY	KEC255	AL
ALBUQUERQUE	KKF900	AQ
ALEXANDRIA	KFQ240	AX
ANCHORAGE	FWA291	AN
ATLANTA	KIE300	AT
BALTIMORE	KGB750	BA
BIRMINGHAM	KEV200	BH
BOSTON	KCB800	BS
BUFFALO	KEX590	BU
BUTTE	KOD200	BT
CHARLOTTE	KEV220	CE
CHICAGO	KSC210	CG
CINCINNATI	KQC390	CI
CLEVELAND	KEX740	CV
COLUMBIA	KEX820	CO
DALLAS	KFP950	DL
DENVER	KAC905	DN
DETROIT	KEX760	DE
EL PASO	KKF920	EP
HONOLULU	KUA270	HN
HOUSTON	KKF925	HO
INDIANAPOLIS	KEX780	IP
JACKSON	KKF962	JN
JACKSONVILLE	KEV280	JK
KANSAS CITY	KEX570	KC
KNOXVILLE	KEV240	KX
LAS VEGAS	KOD245	LV
LITTLE ROCK	KFQ200	LR
LOS ANGELES	KMC250	LA
	KMC265	LA
	KMC275	LA
LOUISVILLE	KIE320	LS
MEMPHIS	KEV260	ME

OFFICE (contd.)	CALL (contd.)	CAR PREFIX (contd.)
MIAMI	KEV300	MM
MILWAUKEE	KSC220	MI
MINNEAPOLIS	KAC920	MP
MOBILE	KIE340	MO
NEWARK	KEX620	NK
NEW HAVEN	KEX600	NH
NEW ORLEANS	KKF940	NO
NEW YORK	KEC270	NY
	KEC271	NY
NORFOLK	KEV340	NF
OKLAHOMA CITY	KFQ220	OC
OMAHA	KEX560	OM
PHILADELPHIA	KEX640	PH
PHOENIX	KEX700	PX
PITTSBURGH	KEX660	PG
PORTLAND	KEX720	PD
QUANTICO	KQC410	—
RICHMOND	KEV360	RH
SACRAMENTO	KFP900	SC
ST. LOUIS	KEX860	SL
SALT LAKE CITY	KOD235	SU
SAN ANTONIO	KEX840	SA
SAN DIEGO	KEX690	SD
SAN FRANCISCO	KFP970	SF
SAN JUAN	WWA290	SJ
SAVANNAH	KEV380	SV
SEATTLE	KOD220	SE
SPRINGFIELD	KEX800	SI
TAMPA	KFV320	TP
WASHINGTON	KGB770	WF

- (2) All radio stations operated from the offices of resident agencies shall use call signs similar to the calls used by field offices. Resident agency call letters are assigned only by the Bureau. Prior Bureau authority is required for any resident agency radio station installation involving remote control or permanent antenna installation.
- (3) Portable radio station units shall use the call sign assigned to the office plus a letter assigned by the office; e.g., KEV300A (Miami).
- (4) Any temporary coded call or designation may be applied to equipment used on surveillance work. The call signs listed above apply only to routine operations.
- (5) All Agents shall be identified on the air by use of their credential card numbers. Names or initials shall not be used although coded names may be used for disguise purposes in surveillance work.

d. Administration

The SAC is directly responsible for the continued proper and efficient operation of the field office FM radio equipment. A radio maintenance technician or sound-trained Agent should be assigned the responsibility for overall operation and maintenance in order that detailed supervision may be maintained.

e. Field office station operation

- (1) Stations shall be operated during office hours of each working day and additional time as investigative situations require.
- (2) Stations having a separate dispatching position shall transmit the station call sign on the hour, quarter-hour, and half-hour during periods when the station is open for business. Stations not having a separate dispatching position shall transmit the station call sign at least once during the course of each series of transmissions, preferably at the end of the series.

- (3) A separate FM radio dispatching position shall be utilized wherever radio traffic is of sufficient volume to require continued attention. Where a separate dispatching position is utilized, and radio dispatching personnel are assigned, no duties shall be assigned the radio dispatcher which will interfere with efficient radio dispatch operations. The prime function of the FM radio station and equipment is to render communications service, and personnel handling radio dispatching duties should be impressed with this fact. Radio dispatcher personnel should be chosen with care and a sufficient number of trained dispatchers should be available so that efficient station operation will be maintained at all times.
- (4) Prior to closing field office stations for the day, the radio dispatcher shall ascertain from all two-way radio cars in service whether or not the services of the station will be required after that time. In the event the station is needed, this fact should be communicated to the appropriate supervisor.
- (5) A numerically sequenced list of Agents' credential card numbers shall be maintained at the dispatching position for the ready information of the dispatcher.
- (6) Personnel using radio cars within radio range of the field office headquarters station shall turn the radio on and advise the radio dispatcher that the car is "in service" at the beginning of a period of car occupancy, advising the radio dispatcher that the car is "out of service" when the car is to be unoccupied. Where a separate dispatching position is utilized, logs will be maintained and the dispatcher will note the service status of two-way radio cars. This status will also be shown on an "in-service" panel where such panel is provided.
- (7) Logs (FD-283) maintained by the dispatcher at those stations utilizing separate dispatching positions will show only the activity of the station and radio cars in direct contact with the station. The log entries shall be made at the time the activity occurs and shall be in sufficient detail for ready reference by dispatching personnel. The dispatcher on duty shall be identified on the log by an entry showing the dispatcher's name and the beginning time of the duty status. Log entries showing station activity handled by personnel other than the duty dispatcher shall be identified by the initials of the personnel handling such activity. Dispatching logs will be reviewed and initialed by the [senior Radio Maintenance Technician and] retained in bound form [to be destroyed] after field office inspection by FBIHQ. [Logs are] not required where no separate dispatching position is utilized, although one may be kept on a continuing or intermittent basis, at the discretion of the SAC. If logs are maintained on a continuing basis, they should be handled as noted above.

f. Security

- (1) [Unauthorized] persons may be equipped with FM receivers which will tune to Bureau frequencies. [Therefore,] all radio transmissions must be discreet. Names of Bureau Agents, subjects, or specific locations involved in Bureau investigative activities shall not be disclosed over FM radio.
- (2) [Unauthorized] persons may possibly have equipment which will transmit on Bureau frequencies. Information should not be exchanged with radio units which cannot be properly identified.
- (3) Agents must use care in handling the mobile microphone to prevent accidental continuous keying of the transmitter.

g. Operational and procedural instructions

- (1) Instructions relating to mechanics and procedures of operation of various radio equipment will be found in other reference material, such as CW Radio Operations Manual, FM Radio Station Operational and Maintenance Guide, and instructional manuals furnished with the various equipment obtained commercially.
- (2) Multichannel station and mobile FM radio equipment, each channel being a separate frequency, has been furnished the field. Normally, the channel one frequency will be used as the primary operating frequency with auxiliary operations being handled on other channels as necessary.
- (3) With the exception of the channel four frequency which is common to all offices, no office will have a frequency used by a neighboring office. All office FM stations normally monitor their own channel one and channel four during regular working hours. Thus, when an Agent in a two-way car enters the territory of another office, he must change to channel four to communicate with the cars and station of that office. The visiting two-way radio car should always use the full name of its office before the number of the car. For example: "Chicago 64" instead of "CG64."
- (4) An FM Radio Station Operational and Maintenance Guide shall be maintained by each office. It shall set forth the make and model of FM radio station equipment in use, location and directions to remote equipment sites, equipment operating procedures, schematic diagrams, preventive maintenance requirements, etc. In those offices having more than one remote station equipment site, this guide shall be maintained under a separate cover and be readily available to both the radio maintenance technician and radio dispatching personnel. In those offices having only one remote station equipment site, this guide may be maintained under the same cover as the maintenance logs (see below), but all personnel who might have occasion to use the radio station facilities should have knowledge as to its contents and location.

- (5). In view of extensive radio equipment used on commercial airlines for navigational and communications purposes, no Bureau transmitting or receiving radio equipment of any kind shall be operated on any commercial airline without prior Bureau authority.

In connection with operation of Bureau radio equipment on noncommercial, military, or personally owned aircraft where the pilot is aware of the Bureau operation, prior authority is not required. It should be predetermined by tests, however, whether interference is being caused to the aircraft equipment and, if so, the extent of the interference.

h. Maintenance

- (1) All FM radio station and associated equipment, including mobile units, shall be maintained by radio maintenance technicians. In those instances in which there are repairs or maintenance problems beyond the ability of the radio maintenance technician, such repairs or maintenance may be referred to a local commercial radio repair company under a radio repair contract. If the total of such costs does not exceed \$2,500 in a fiscal year, such repairs and maintenance may be handled on an emergency purchase basis and no contract is necessary. The facilities of the FBI Laboratory are also available for assistance to the field in difficult or unusual repair and maintenance problems.
- (2) Ticklers should be set up for periodic performance of preventive maintenance procedures. In addition to local preventive maintenance and repair, periodic maintenance overhauls will be performed by radio installation and maintenance supervisors of the FBI Laboratory.
- (3) Portable equipment should never be put away after use until all necessary repairs are made. Equipment utilizing batteries should have the batteries removed prior to storage, storage being defined in this instance as any condition in which the equipment will be retained for a period of seven days or longer without the batteries being checked.
- (4) No equipment may be altered without specific authorization from the Bureau.
- (5) Maintenance and repair records for all standard FM and CW radio equipment must be kept on a radio equipment maintenance log, form FD-341. Maintain form FD-386 (comsec and related equipment maintenance log) on each communications security device (AFSAM-7, KW-7, KY-3, KY-8, NY-1, KWX-11), or related device (modified FM radio), and each Bureau-owned teletypewriter. A separate log, either FD-341 or FD-386, as appropriate, must be maintained for each unit of equipment and information concerning any maintenance or repair action taken must be recorded under the appropriate heading. Forms FD-341 and FD-386 should be kept in appropriately identified looseleaf notebooks or in a card file arrangement, all forms pertaining to particular groups of equipment being maintained together. Logs maintained on classified comsec equipment must be given the same classification as the equipment; i.e. secret, confidential, etc. Classified logs must be maintained in a separate notebook or card file in a secure place.

When new equipment is received on which no maintenance log has been prepared and shipped with the equipment, a log sheet must be prepared. Make entries on occasion of any repairs or parts replacement noting time spent and initials of technician doing the work. These logs are to serve as a continuing record through the life of the equipment and are to be transferred with the equipment, including its return to the Bureau or other maintenance facility where a record of previous repairs or malfunctions would be of assistance. Responsibility for maintenance of the logs must be fixed on a specific employee.

- [(6) To enable the Bureau to have information as to the relative maintenance requirement rating of each field office, it will be required that summary data be supplied periodically to the Bureau, attention FBI Laboratory, as to the amount of radio equipment assigned. Summary data should be supplied each time it is recommended Radio Maintenance personnel be increased in number or reallocated in grade, or when it is determined that the amount of equipment has changed to the extent that it would result in a change of approximately 25 or more maintenance rating points since submission of the most recent summary. Information should be set forth as to the number of the following items only, with the maintenance rating points (average maintenance hours per month required) as indicated below:

Mobile FM Radio Station, 2 or less channels	1 point
Mobile FM Radio Station, 3 to 5 channels	1.75 points
Mobile FM Radio Station, 6 or more channels	3 points
Portable or Personal FM Radio Unit	.5 points
Remote FM Radio Receiver (landline connected)	2 points
Locally Controlled Fixed FM Radio Station	3 points
Remotely Controlled Fixed FM Radio Station (landline)	7 points
Intra-System Repeater FM Radio Station	6 points
Resident Agency Burglar Alarm System (RABAS)	3 points
Secure Teletype Terminal	13 points
Microwave Terminal (Main or Hot Standby)	15 points

This list does not contain all items of radio and associated equipment but does constitute the bulk of the equipment for which the Radio Maintenance Technicians are responsible in most offices. Special consideration will be given by the Bureau to those offices having other than normal responsibilities in connection with the Bureau's emergency radio network, or specialized facilities.]

i. Fire and safety

- (1) A carbon dioxide fire extinguisher shall be readily available in radio dispatching rooms in which several items of remote control equipment are used.
- (2) Where transmitter or antenna repair or maintenance work is being performed under any unusual situation, such as adverse weather conditions, hazardous equipment, or antenna locations, etc., or where high voltage is exposed, one other person shall be on hand to provide emergency assistance.
- (3) A first-aid kit should be readily available whenever radio repair work is being performed.
- (4) Any reasonable requests for fire and safety precautions from persons leasing space for radio equipment to the Bureau should be granted unless it is contrary to local regulations.
- (5) Gasoline motor generator installations must comply with local fire and safety regulations. In addition, if not in conflict with local regulations, "No Smoking" signs shall be posted and a carbon dioxide fire extinguisher must be readily available where gasoline is stored.
- (6) Common sense and good judgment should be used to determine the necessity for other or additional fire and safety precautions.

2. Radio matters handled by FBI Laboratory

- a. Engineering, installation, and major maintenance of CW (Morse code), radioteletype, and FM (voice) radio stations
- b. Special engineering summaries and surveys regarding field investigative equipment, from which recommendations can be made toward establishment of Bureau policies on a field-wide basis
- c. Technical examination and evaluation of new developments in radio communications. Agents should be alert to furnish information concerning new developments which might be applicable to Bureau's work.
- d. Preparation of detailed specifications for radio equipment to be purchased for communications use
- e. Special construction of radio equipment not normally manufactured commercially
- f. Development and research in the field of radio communications. Agents should submit any information regarding current investigative problems, such as those encountered in surveillance work, where a possible solution lies in utilization or development of special radio equipment.
- g. Assistance in installation of equipment for radio monitoring, physical surveillances involving special radio techniques, and other nonroutine radio utilization

- h. Repair and maintenance of field radio equipment
- (1) Where unusual problem exists, such as need for special test equipment not available locally
 - (2) Miniature and subminiature radio equipment which due to its confidential nature is to be serviced only by Bureau personnel
 - (3) Equipment submitted to Bureau for repair should be marked for the attention of the FBI Laboratory.
- i. Physical examinations of evidence, such as determination of possible sabotage or identification of a particular piece of radio equipment
- j. Field requests for radio and related specialized equipment
- (1) Requests from field to be made by letter marked for the attention of the FBI Laboratory.
 - (2) Mobile two-way radio units will be supplied the field, as available, on receipt of request for units to be used as follows:
 - (a) In field office headquarters city area
 - (b) Where two or more two-way radios will be used in a resident agency
 - (c) Where a cooperative police agency is willing to allow Bureau radio cars to operate on its frequency to communicate with that agency
 - I. When appropriate, consideration should be directed toward the law enforcement system covering the greatest area; e.g., a state or county.
 - II. The initial request for two-way radio for use with a police system should set forth the specific operating frequencies of the system and the number of Bureau cars involved. There should be a statement that the head of the law enforcement agency, identified by name and position, e.g., director of public safety, chief of police, or sheriff, having control over the police radio transmitter, has indicated a willingness or desire that the Bureau operate radio equipment on the police frequency used in that area.
 - III. Before completion of installation of a two-way mobile radio on a police frequency in a Bureau car, the head of the law enforcement agency (see item II above) should advise SAC of that field office, in writing, that he desires or is willing to have Bureau radio equipment operating on the police frequency. A signed copy of letter, [which should include number and expiration date of Federal Communications Commission (FCC) license for each frequency,] should be forwarded to Bureau. Bureau is required to advise FCC, in writing, that a cooperative plan is in effect between Bureau and police agency. The law enforcement agency should not send the communication concerning this directly to FCC.
 - IV. Use of police frequencies is restricted to communications between Agents and police agency involved, or to the relay of important messages from Bureau office to Agents on road trips where police agency has agreed to perform this service. Police frequencies should not be used for Bureau-car-to-Bureau-car radio operations in which the police agency is not directly involved.
 - (3) Routine radio and related supplies, such as radio tubes, mobile antennas, mobile feed lines, etc., are handled by the Administrative Division and should be requested by regular requisition.
- k. Radio frequencies used by the Bureau are authorized by the President in accordance with section 305 of the Communications Act of 1934, as amended. Bureau frequencies are authorized and protected through Bureau representation on the Interdepartment Radio Advisory Committee in Washington, D. C.

1. Interference

The Bureau is authorized exclusively on the radio frequencies it uses. Consequently, there should be no transmissions except those of Bureau personnel. Any other transmission of voice or other signal is interference. Each instance of interference should be reported to [the dispatcher.]

3. Sound matters handled by the field

a. Operation and use of technical equipment in investigative situations

- (1) Installation of equipment
- (2) Establishment of monitoring plants

b. Technical equipment maintenance

- (1) Maintain equipment in excellent working order at all times.
- (2) No part or function of any equipment may be altered without specific Bureau authorization.
- (3) Equipment should never be placed in storage or standby condition until necessary servicing has been accomplished.
- (4) Servicing, maintenance, and operational checks will be performed by a sound-trained Agent. Sufficient time must be allotted this Agent to adequately fulfill these requirements. The sound Agent will be assisted in repairs to sound equipment by the radio maintenance technician provided that such activity does not interfere with his primary responsibilities to radio communication equipment.
- (5) Perform servicing and maintenance procedures on equipment.
- (6) Once every thirty days, set up and check equipment for continued proper operation.
- (7) Keep equipment maintenance log in a 6- by 9-inch loose-leaf binder entitled "Sound Equipment," said binder to contain a log sheet for each particular piece of sound equipment. This sheet should be captioned with the description and serial number of the unit and show the service history of the unit. The dates of any defects, corrective action taken, preventive maintenance performed, operational checks, and by whom accomplished must be shown. When equipment is transferred to another division, the log must accompany the equipment.
- (8) Radio and sound safety equipment, such as pole climbing equipment, safety belts, etc., is to be checked each six months.
- (9) Field requests for specialized technical equipment should be directed to the Bureau, attention FBI Laboratory. When specialized technical equipment is requested on an expedite basis, a statement as to the proposed usage of the equipment is to be included. The statement is to include sufficient details for the Bureau to properly evaluate the needs of the field office and to determine the most economical means of shipping the necessary equipment. Other equipment requests should be referred to the Administrative Division.
- (10) Repairs to sound equipment beyond the scope of the field may be referred to the Laboratory, and equipment so transferred should be marked for the attention of the FBI Laboratory and be accompanied with a brief statement of the trouble.

4. Speaker identification

- a. All speaker identification examinations are made by the Radio Engineering Section, FBI Laboratory.
- b. Definition
Speaker identification is a technique of comparing questioned voice recordings with known voice recordings for the purpose of providing investigative guidance in selected Bureau cases.
- c. Policy
Speaker identification is not sufficiently authenticated to serve as a unique means of identification with subsequent court testimony to that effect. The comparison of voices for speaker identification and the examination of tape recordings are not services which will be provided to local law enforcement agencies.
- d. Procedure for obtaining and transmitting specimens
 - (1) It is desirable to obtain as many of the same words and word combinations used in the questioned recording as possible when making known recordings.
 - (2) The vocal transition from one word to another influences the voice picture; therefore, best comparisons are achieved when words are used in the same sequence.
 - (3) Recordings should be as good technically as possible.
 - (4) Recordings should be at any standard tape recording speed; i.e., 7.5 inches per second, 3.75 inches per second, etc.
 - (5) Best results will be obtained if recordings are made with a full-track recorder at 7.5 inches per second.
 - (6) Use standard recording tape. If possible, do not use "extended play," "long play," or tapes with a base less than 1.5 mils.
 - (7) Verbatim transcriptions of known and questioned material must accompany each recording.
 - (8) For packaging, wrapping, and mailing magnetic tape recordings, see section 8B, volume I, of this manual.
 - (9) Deleted

5. Technical correspondence

All correspondence concerning technical matters is to be reviewed by the senior sound-trained Agent or technical supervisor prior to being approved by the SAC or other official acting for him. The purpose of this instruction is to insure that requests for technical equipment and other correspondence relating to technical matters are cleared through the individual in the office having the most current knowledge of equipment availability, equipment capability, technical procedures, and technical policies.

6. Approval for use of technical equipment

Bureau approval is required prior to the utilization of any technical equipment for covert gathering of intelligence without the knowledge of the subject, such as two-way mirrors, night viewing devices, concealed cameras, portable concealed recorders, etc. The examples set forth are not meant to be all-inclusive but are merely examples of the type of activity this instruction is intended to cover. The special surveillance truck may be used on the SAC's authority when, in his opinion, its utilization is essential for the success of the surveillance in question. SACs have been advised of certain situations in which concealed cameras may be used on the SAC's authority. The SAC will be held accountable for exercising sound judgment in each instance.

[R. DATA PROCESSING SECTION, COMPUTER SYSTEMS DIVISION

1. Automatic Data Processing (ADP) assistance is provided by the Data Processing Section (see MRR, part II, section 3, pages 28 & 29).
2. Computers and other Automatic Data Processing Equipment (ADPE) are involved in every facet of business and Government. Therefore, it is very likely that computers or other ADPE may be directly involved in a criminal violation or a security matter of FBI jurisdiction. The Data Processing Section should be immediately contacted. Expert ADP personnel are available to provide assistance.]

8/5/75
Request

III - F

ESTABLISHMENT AND FUNCTIONS OF THE
FBI EXTERNAL AFFAIRS DIVISION

RETAIN

This document is prepared in response to your request and is not for dissemination outside your Committee. Its use is limited to official proceedings by your Committee and the content may not be disclosed to unauthorized personnel without the express approval of the FBI .

274-10/28

UNITED STATES GOVERNMENT

Memorandum

TO : THE ACTING DIRECTOR

DATE: June 1, 1973

FROM : W. M. FELT *W.M. Felt*

SUBJECT: PROPOSED RE-ESTABLISHMENT OF
DIVISION PREVIOUSLY ABOLISHED BY
FORMER ACTING DIRECTOR GRAY

<i>W.M. Felt</i>	_____
Mr. Baker	_____
Mr. Callahan	_____
Mr. Cleveland	_____
Mr. Conrad	_____
Mr. Gebhardt	_____
Mr. Jenkins	_____
Mr. Marshall	_____
Mr. Miller, E.S.	_____
Mr. Soyars	_____
Mr. Thompson	_____
Mr. Walters	_____
Tele. Room	_____
Mr. Baise	_____
Mr. Barnes	_____
Mr. Bowers	_____
Mr. Herington	_____
Mr. Conny	_____
Mr. Mintz	_____
Mr. Eardley	_____
Mrs. Hogan	_____

In December, 1972, former Acting Director L. Patrick Gray, III, dissolved what was then known as the Crime Research Division. Prior to Mr. Gray's arrival, this was for many years known as the Crime Records Division; however, Mr. Gray changed the name to Crime Research Division. Quite frankly, at the time Mr. Gray made his decision to dissolve the division I was opposed to such action as were several Assistant Directors. Nevertheless, Mr. Gray went ahead on the basis of a study that had been made; however, the origin of this study is not known to me nor have the results ever been located to my knowledge. Upon the dissolving of the division, the various segments that previously constituted the division have been spread out in several divisions and the result has been overlapping of responsibilities, lack of coordination and a situation which simply does not lend itself to efficient operations as we have known them to be for many years at FBIHQ.

To give an idea as to how fragmented this division has become, the Press Services Office and Congressional Liaison are now handled out of your office; tours are handled out of the Administrative Division; correspondence and research matters out of the Files and Communications Division; fugitive publicity out of the Special Investigative Division; and special memoranda out of the General Investigative Division. An indication of how chaotic the situation has been is evidenced by the fact that the Correspondence Section, after abolishment of the division, was assigned to my office and subsequently we prevailed upon Mr. Gray to assign it to Files and Communications Division.

It is true that this former division did handle public relations-type functions; however, in doing so they were in effect promoting our investigative interests which is the very reason for the FBI's existence. On the other hand, a great portion of the work in this former division was one of service, not only to the other divisions but to our field office operations. For example, the division handled almost all of the correspondence emanating from FBIHQ, which ran into thousands of communications each year. They handled all

Enclosure *DELETED*

WMF:ams

(2)

CONTINUED - OVER

Memorandum for the Acting Director
Re: PROPOSED RE-ESTABLISHMENT OF
DIVISION PREVIOUSLY ABOLISHED BY
FORMER ACTING DIRECTOR GRAY

speech matters, publication of the Law Enforcement Bulletin and the Investigator; they prepared byline articles; statements by the Director; speeches for the Director; press releases; and publicity concerning apprehension of fugitives and the Top Ten program. When the division was intact, it was kept informed of matters of pertinence to the Bureau so that they could effectively discharge their responsibilities at one central location. As it is now, there is a lack of coordination and in time I strongly feel that it will work to the severe detriment of the FBI.

This situation was discussed in detail at an Executives' Conference meeting held in my office on 5/24/73. Those in attendance were Messrs. Baker, Callahan, Gebhardt, Marshall, Soyars, Thompson, Walters, Inspector White for Mr. Conrad, Section Chief Brownfield for Mr. Jenkins, Inspector Moore for Mr. Miller, and Inspectors Campbell and Bassett from my office. It was the unanimous recommendation of those present that the division be re-established.

I have enclosed a proposed organizational chart which shows the organizational breakdown of the suggested division. As you will note under the proposal, the Press Services Office and Congressional Liaison office, now assigned to your office, would be placed back into this division as these functions were previously handled in the old Crime Research Division.

There was also discussed at the above Executives' Conference meeting a proposed name, should you agree to establish a new division. Its prior name of Crime Records is really a misnomer, since our crime records are actually kept and published by our Computer Systems Division. Crime Research does not adequately describe the division; however, I do believe that the name of Correspondence and Services Division would adequately describe the basic functions of this division.

RECOMMENDATION:

Submitted for your consideration and approval.



D
Executives Div. 7-2-73

TO: MR. KELLEY

RE: CRIME RECORDS DIVISION

I am attaching a memorandum dated 6-1-73 which proposed the re-establishment of our old Crime Records Division. I recognize fully that there are a million and one things to do, but I thought you might like to look this over at your convenience since it might give you some thoughts as to re-establishing that division. As indicated in the memorandum, it was the unanimous recommendation of the Executives' Conference; however, Mr. Ruckelshaus took no action since he did not want to make any major changes during his short tenure.

NICK
NICK

Enc.

4/8/76
CP *mgk*

Nick - I am not opposed to re-establishment of some sort of structure. Have something drawn up as a recommendation - See me pls for my ideas - Curt

ENC. 25

REC 131
~~80004-1401X1~~
7 OCT 9 1976

UNITED STATES GOVERNMENT

Memorandum

TO : THE DIRECTOR

DATE: 7-12-73

FROM : N. P. CALLAHAN

External Agency = Div.

SUBJECT: PROPOSED RE-ESTABLISHMENT OF
CRIME RECORDS DIVISION

- Mr. Felt _____
- Mr. Baker _____
- Mr. Callahan _____
- Mr. Cleveland _____
- Mr. Conrad _____
- Mr. Gebhardt _____
- Mr. Jenkins _____
- Mr. Marshall _____
- Mr. Miller, E.S. _____
- Mr. Soyars _____
- Mr. Thompson _____
- Mr. Walters _____
- Tele. Room _____
- Mr. Baise _____
- Mr. Barnes _____
- Mr. Bowers _____
- Mr. Herington _____
- Mr. Conny _____
- Mr. Mintz _____
- Mr. Eardley _____
- Mrs. Hogan _____

The purpose of this memorandum is to recommend consideration of the re-establishment of our old Crime Records Division.

As a matter of background, in December, 1972, former Acting Director L. Patrick Gray, III, dissolved what was then known as the Crime Research Division (Mr. Gray had changed it to this name from Crime Records Division). It is my understanding that Mr. Gray took this action based on a study that had been made; however, nothing is known as to the origin of this study nor have the results ever been located to my knowledge. I might add that former Acting Associate Director W. Mark Felt likewise knew nothing as to the origin or the results of this study. It is known that Mr. Gray's decision to dissolve the division was not shared by several Assistant Directors and while there is nothing in writing it is my understanding that perhaps the main reason for Mr. Gray taking this action was his belief that that division was responsible for several leaks that had appeared in the newspaper which were detrimental to Mr. Gray's administration of the FBI. I am not aware, however, of the validity of this observation but it is merely set forth so that you may have a complete picture as to the circumstances surrounding the dissolution of the Crime Research Division.

In any event, upon dissolving of the division various segments that previously constituted the division were spread out throughout the Bureau and while we have been able to put part of it back together there is a lack of coordination which amounts to a decentralization of responsibilities which definitely does not lend itself to the efficient operations of the Bureau.

To give an idea as to how fragmented this division has become, the Press Services Office and Congressional Liaison are now handled out of the Director's Office, Tours out of the Administrative Division, Correspondence and Research matters out of the Files and Communications Division, Fugitive Publicity out of the Special Investigative Division. At one time the Correspondence Section was attached to the Associate Director's Office and the Research Section was attached to the Training Division. These of course were two key sections

Enc.

HNB:pmd (2)

80004-1401X2

(OVER)

OCT 9 1973

6 3-7/k

Memorandum to the Director from N. P. Callahan
Re: Proposed Re-Establishment of Crime Records Division

under the old division setup and we were finally able to prevail upon Mr. Gray to consolidate the 2 into 1 section and assign it to the Files and Communications Division. This step has assisted to some extent, but the continuity and coordination as we knew it under the overall division setup is still lacking.

You have indicated a desire to establish an amiable working relationship with the press. I could not agree more; however, to do so, it is firmly believed that one division should be basically responsible for this function. It would mean that the Assistant Director of this division would have to re-establish press contacts as well as the whole gambit of the news media, including radio, television, feature writers, and the like. Centralizing this responsibility to one division as was handled in our old Crime Records Division would coincide with the long-standing Bureau policy that has been so effective; namely, centralization of responsibilities. For example, as indicated previously, the Press Services Office and Congressional Liaison Office now work directly under you. This in effect makes your office operational and adds certain burdens to you which are unnecessary. It is true that some people might argue that re-establishing this division would be the first step in a Bureau public relations program. I do not agree with this concept because in effect this action would be promoting our investigative interests which is the very reason for the FBI's existence and probably never before have we so needed a shot in the arm to promote our investigative interests.

Also, as a matter of background this current proposal has been considered very carefully since Mr. Gray's departure and it was the unanimous feeling of the Executives Conference held as recently as May of 1973, that the division should be re-established. Mr. Ruckelshaus had orally indicated his agreement but also felt in view of his anticipated short tenure he should not be involved in any major Bureau changes.

Enclosed is a proposed organizational chart which shows the organizational breakdown of the suggested division. The breakdown is also a suggested one; however, as you will note, the Press Services Office and Congressional Liaison Office would be placed back into this division. As to a name for this division, Crime Records is really a misnomer since our crime records are actually kept and published by our Computer Systems Division. Crime Research Division does not adequately describe the division and other names which would

Memorandum to the Director from N. P. Callahan
Re: Proposed Re-Establishment of Crime Records Division

include say the word "publication" run into problems from an appropriations standpoint. Perhaps Correspondence and Services Division would adequately describe the basic functions of the division.

RECOMMENDATION:

The above is submitted for your consideration and perhaps in the event you would like to discuss this matter in detail it might be placed in line for an early discussion at an Executives Conference.

CORRESPONDENCE AND SERVICES DIVISION

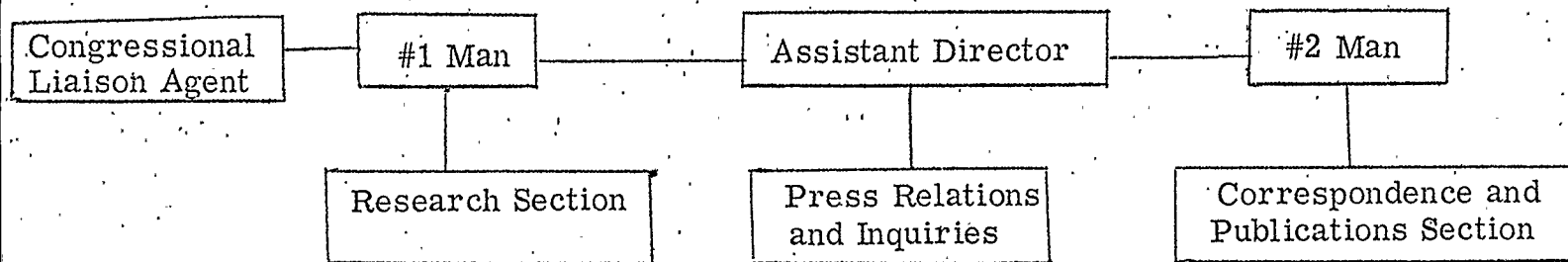

Research Section
Section Chief

#1 Man

Special Productions Unit
(Unit Chief & 2 Agents)

Research Unit
(Unit Chief & 4 Agents)

Fugitive Publicity Unit
(Unit Chief & 2 Agents)

Tours Unit
(Unit Chief)

Radio
Television
Motion Pictures
Official Photographs
Recordings
National Academy
Publicity
Photographs in Director's
Office

Articles
Statements
Speeches
Research
Annual Report
Reference Library
Out-of-town
Telephone Directories
Parole, Probation, Juvenile
Delinquency and Pornographic
Research
Young American Medals

Press Releases
Top Ten Publicity
"Fugitive" Articles in
Trade Journals
Public Law 670
Newspaper Clippings
Traveling Exhibits

Tours
Complaints
Interviews of Citizens

Correspondence and Publications Section
Section Chief

#1 Man

Special Correspondence Unit
(Unit Chief & 2 Agents)

Congressional Mail
Special Mail
Speech Programs
SAC Contacts
Autographed Photographs

Nonspecial Correspondence Unit
(Unit Chief)

Routine Mail
Mailing List
Chronic Letter Writers
Form Mail
Editorial Records
Supplies
Inventory
Distribution of Law Enforcement
Bulletin, Uniform Crime Reports,
Investigator, and other publications

Publications Unit
(Unit Chief & 1 Agent)

Law Enforcement Bulletin
Investigator
Revision of Publications
Interesting Case Program
Liaison with Government Printing
Office
Reprints
Posters
Booklets

Correspondence Review Unit

UNITED STATES GOVERNMENT

Memorandum

TO : MR. CALLAHAN

DATE: 7/30/73

FROM : R. J. BAKER *[Signature]*

- 1 - Mr. Callahan
- 1 - Mr. Walsh
- 1 - Mr. Cleveland
- 1 - Mr. Gebhardt
- 1 - Mr. Miller
- 1 - Mr. Marshall
- 1 - Mr. Baker
- 1 - Mr. Sheets

SUBJECT: PROPOSED RE-ESTABLISHMENT OF
CRIME RECORDS DIVISION

External Affairs Div.

- Assoc. Dir. _____
- Asst. Dir.: _____
- Admin. _____
- Comp. Syst. _____
- Files & Com. _____
- Gen. Inv. _____
- Ident. _____
- Inspection _____
- Intell. _____
- Laboratory _____
- Plan. & Eval. _____
- Spec. Inv. _____
- Training _____
- Legal Coun. _____
- Cong. Serv. _____
- Corr. & Crm. _____
- Research _____
- Press Off. _____
- Telephone Rm. _____
- Director Sec'y _____

Memorandum Callahan to the Director dated 7/12/73, captioned as above, forwarded to the Director a proposed reorganization chart (Memorandum and chart, Tab A). Pursuant to instructions of the Director, the Office of Planning and Evaluation (OPE) has analyzed the chart and offers the following observations in support of a revised organization chart (Tab B).

An analysis of the proposed chart, Tab A, discloses it was envisioned that the Congressional Services Office and the #1 Man would be one and the same with a Congressional Liaison Agent and the Research Section reporting to him. He in turn would report to the Assistant Director. Press relations and inquiries (Press Services Office) would be handled directly out of the Assistant Director's Office. The Correspondence and Publications Section would report to the #2 Man, who would report to the Assistant Director.

It is the opinion of OPE that the #1 Man cannot effectively function as the head of the Congressional Services Office and at the same time afford direction and supervision to the Research Section, and in addition substitute for the Assistant Director in his absence. Further, with the formation of the Congressional Oversight Committee increased demand will be made on the Congressional Services Office. The Congressional attention being afforded the Bureau and the importance of the Bureau's relations with Congress require that the Congressional Services Office report directly to the Assistant Director. The role of the Research Section in projecting the Bureau's image is of sufficient import as to mitigate against undue dilution of the #1 Man's supervision of that section. Press relations and Congressional relations should be of highest priority for the Assistant Director of the reconstituted division and it is for these reasons that OPE recommends that the Congressional Services Office as presently constituted report directly to the Assistant Director as would the Press Services Office.

2 ENCLOSURE

EES:DW (9)
Enclosure

ENC 131

8-0004-1401X3

(CONTINUED - OVER)

[Signature]

Memo R. J. Baker to Mr. Callahan
Re: Proposed Re-establishment of
Crime Records Division

A review of the proposed chart, Tab A, discloses that the Correspondence and Publications Section has under it the Publications Unit and the Research Section has under it the Tour Unit. The Publications Unit should more properly be assigned to the Research Section as the work it performs is related functionally to the other work of the Research Section. The Publications Unit draws heavily upon the resources of the Research Section in performing its functions, more particularly the preparation of the Law Enforcement Bulletin and the Investigator.

The Tour Unit could be assigned to either section; however, for balance of supervision it is suggested the Tour Unit be assigned to the Correspondence Section as it was before the division was dissolved.

During this analysis, the question of consolidating the liaison functions of all divisions into one section was considered. It was determined that the liaison functions of the divisions, other than Congressional liaison, are operational functions peculiar to those divisions. For example, liaison operations within the Intelligence Division are oriented toward the intelligence community, whereas relations with the Federal Aviation Administration are more properly tied to the General Investigative Division, which handles aircraft crimes. This arrangement is presently in operation and functions efficiently. To alter it purely for consolidation purposes would be counterproductive.

RECOMMENDATION

That the revised organization chart proposed by OPE, Tab B, be adopted.

RM

Frank

Mrs. M. - Put in folder for discussion with E.C. pls

Mr. Callahan -

9-4-73 - Establishment SAC Frank as A.D.

Unit

PUBLIC INFORMATION AND RESEARCH DIVISION

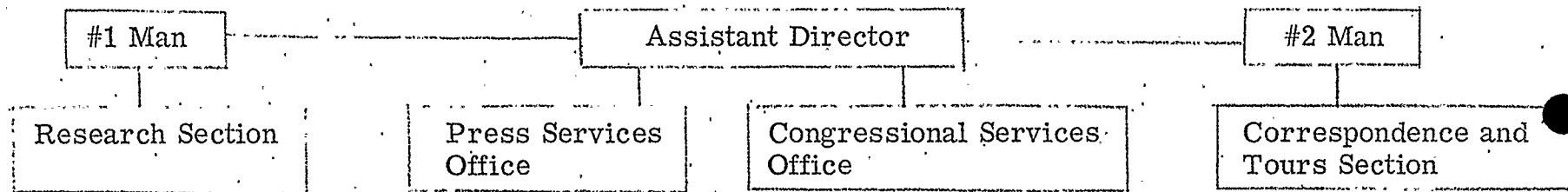

Correspondence and Tours Section
Section Chief

#1 Man

Special Correspondence Unit

Correspondence Review Unit

Nonspecial Correspondence Unit

Tours Unit

Congressional Mail
Special Mail
Speech Programs
SAC Contacts
Autographed Photographs

Routine Mail
Mailing List
Chronic Letter Writers
Form Mail
Editorial Records
Supplies
Inventory
Distribution of Law Enforcement
Bulletin, Uniform Crime Reports,
Investigator, and other publications

Tours
Complaints
Interviews of
Citizens

Research Section
Section Chief

#1 Man

Special Productions Unit

Radio
Television
Motion Pictures
Official Photographs
Recordings
National Academy
Publicity
Photographs in Director's
Office

Research Unit

Articles
Statements
Speeches
Research
Annual Report
Reference Library
Out-of-town
Telephone Directories
Parole, Probation, Juvenile
Delinquency and Pornographic
Research
Young American Medals

Fugitive Publicity Unit

Press Releases
Top Ten Publicity
"Fugitive" Articles in
Trade Journals
Public Law 670
Newspaper Clippings
Traveling Exhibits

Publications Unit

Law Enforcement Bulletin
Investigator
Revision of Publications
Interesting Case Program
Liaison with Government
Printing Office
Reprints
Posters
Booklets

UNITED STATES GOVERNMENT

Memorandum

- Assoc. Dir. _____
- Asst. Dir.:
- Admin. _____
- Comp. Syst. _____
- Files & Com. _____
- Gen. Inv. _____
- Ident. _____
- Inspection _____
- Intell. _____
- Laboratory _____
- Plan. & Eval. _____
- Spec. Inv. _____
- Training _____
- Legal Coun. _____
- Cong. Serv. _____
- Corr. & Crm. _____
- Research _____
- Press Off. _____
- Telephone Rm. _____
- Director Sec'y _____

TO : Mr. N. P. Callahan

DATE: August 6, 1973

FROM : E. S. Miller *EM*

External Affairs Div

SUBJECT: PROPOSED RE-ESTABLISHMENT OF
CRIME RECORDS DIVISION

At the ~~Executive~~ Executives Conference, July 25, 1973, Mr. Kelley designated Messrs. Marshall, Jenkins, Gebhardt, Baker, Cleveland, and Miller to form a Committee to recommend a candidate to be the new Assistant Director of the proposed new division which will handle responsibilities formerly assigned to the Crime Records Division. Mr. Kelley indicated that he wanted the Committee's recommendations by 8/10/73 in order that he could make an announcement regarding the new division by 8/15/73. Mr. Kelley also wanted the Committee's recommendations concerning the name of the proposed division.

Subsequently, Mr. Walsh was added to the Committee with Director Kelley's concurrence.

On 8/1/73 the Committee met to discuss logical candidates to head up the new division. All of the Committee members present presented the names of the same three candidates for the position; that is, SAC Rex I. Shroder, San Diego Office; SAC John J. McDermott, Washington Field Office; and SAC Robert Russ Franck, Organized Crime Division-New York Office.

Considerable discussion followed regarding the qualifications of each man to fill this position and it was agreed that each could handle the position although because of personality differences, et cetera, each would approach the responsibilities in the position from a different standpoint, that is, each had his own strengths as compared with the other men. For example, it was acknowledged by all Committee members that SAC Franck would be the strongest candidate from the liaison standpoint but that the other two SACs were probably stronger from an administrative standpoint.

The consensus of the group was that these three men were so nearly comparable for this position that you could "cover them."

ESM:lml (5)

- 1 - Mr. N. P. Callahan
- 1 - Personnel File of Rex I. Shroder
- 1 - Personnel File of John J. McDermott
- 1 - Personnel File of Robert Russ Franck

70004-1402

CONTINUED - OVER

PERMANENT BRIEFS OF REX I. SHRODER, JOHN J. MC DERMOTT AND ROBERT RUSS FRANCK ATTACHED

7-W.P. XERO. 3 per
 SEP 7 1973
 27 1973

Memorandum to Mr. N. P. Callahan
Re: PROPOSED RE-ESTABLISHMENT OF
CRIME RECORDS DIVISION

with a dime." However, the Committee rated them in the following order: (1) SAC Rex I. Shroder, (2) SAC John J. McDermott, and (3) SAC Robert Russ Franck.

As regards SAC Shroder, Committee members recalled that he was also a candidate for the position of Assistant Director of the Computer Systems Division; however, at that time recollections were that Mr. Shroder preferred for personal reasons to withhold his name from consideration due to the fact that he was in some way involved with the support or care of an aged mother. The recollections are not entirely clear on this issue but it is being mentioned since it may have some bearing on the Director's action in this appointment.

Due to the fact that the Committee feels that each candidate mentioned is qualified to handle the responsibilities of Assistant Director of the new division and since this new position is critically important to the Bureau, the Committee concluded that it would be well for Mr. Kelley to personally interview each of the candidates prior to making his selection. In this regard, members of the Committee are available to discuss in detail what the Committee felt were the special qualifications of each candidate for the job.

Name of Division

Various names for the new division were discussed including "Public Information and Research Division" and "Correspondence and Research Division," which had been previously suggested. It was pointed out that there is a prohibition against the use of the "Public Information" concept since this is already in use by the Department and since each Department can have only one such service.

It was also felt that the use of the word "Correspondence" in the title might convey to a critical public that we are devoting an entire division merely to handle correspondence matters although the Committee was sure that there would be some understanding that this problem represented quite a large volume of work in the Bureau. The Committee concluded that a more appropriate name for the new division would be "Research and Services Division" since all functions logically fell under these descriptive terms. The Committee, therefore, unanimously agreed that this would be an appropriate name.

CONTINUED - OVER

Memorandum to Mr. N. P. Callahan
Re: PROPOSED RE-ESTABLISHMENT OF
CRIME RECORDS DIVISION

RECOMMENDATIONS:

(1) That the Director consider personally interviewing SACs Shroder, McDermott, and Franck for the purpose of selecting the Assistant Director of the new division. Prior to this, he may wish to meet with members of the Committee to briefly discuss the qualifications of each of the men. Following Mr. Kelley's selection of the new Assistant Director, a press release will be prepared along the lines Mr. Kelley instructed in the Executives Conference.

*Agree - however my order of preference is 1-Franck
2-Shroder
3-McDermott
over*

(2) That the name of the new division be "Research and Services Division."

*Rec'd to Jenkins
2/6/73 my approval.*
AW
gm
REG
WVC
EM

This is being further considered - a more suitable title is needed. Miller is following up.
8/1

UNITED STATES GOVERNMENT

Memorandum

- Assoc. Dir.
- Asst. Dir.:
 - Admin.
 - Comp. Syst.
 - Files & Com.
 - Gen. Inv.
 - Ident.
 - Inspection
 - Intell.
 - Laboratory
 - Plan. & Eval.
 - Spec. Inv.
 - Training
 - Legal Coun.
 - Cong. Serv.
 - Corr. & Crm.
 - Research
 - Press Off.
 - Telephone Rm.
 - Director Sec'y

TO : Mr. N. P. Callahan

DATE: September 5, 1973

FROM : E. S. Miller *EM*

SUBJECT: PROPOSED RE-ESTABLISHMENT OF
CRIME RECORDS DIVISION *Ext. Affairs Div.*

Miller to Callahan memorandum dated 8/6/73 (copy attached) recommended consideration be given to naming proposed new division "Research and Services Division." You felt that we might be able to choose a more appropriate name and, therefore, additional effort has been expended in this direction.

Mr. Baker and Mr. Marshall have submitted the following names for consideration:

- Public Affairs Division
- Public Affairs and Resources Division
- Public Affairs and Information Division
- Reference and Services Division
- Special Services Division
- Productions and Services Division
- Liaison and Services Division
- Public Services Division
- Congressional Affairs and Services Division
- Media Affairs and Services Division
- Technical Services Division
- Technical and Services Division
- General Services Division
- Services Division
- Resources and Services Division
- Support Services Division
- Special Activities Division

80004-1416
SEP 27 1973

While these have some appeal, it is not felt for the reasons set out in the attached memorandum that these names are appropriate. In my discussion with you, it was pointed out that "External Affairs Division" seems to do the job fairly well since it is nonspecific and since on the other hand it explains fairly precisely what the functions of the new division will be, that is, handling Bureau affairs external to the Bureau itself including liaison with Congress, correspondence, and liaison with media personnel. For this reason I feel that this name should be

Enclosure
ESM:lml (3)
1 - Mr. N. P. Callahan
1 - Mr. E. S. Miller

ENCLOSURE

[Signature] 9 SEP 25 1973

CONTINUED OVER -

PERS. SEC. UNIT

5-EM/wal

8
OCT 4 1973

Memorandum to Mr. N. P. Callahan
Re: PROPOSED RE-ESTABLISHMENT OF
CRIME RECORDS DIVISION

considered further. I have contacted most of the other Assistant Directors on the Committee and they agree this suggestion has merit.

RECOMMENDATION:

That consideration be given to naming the new Division "External Affairs Division", (~~or some variation of this~~)

*Transmitted letter
and signature letter
prepared under date
of 9/10/73
EW 9/7*

EM

OK

Mr. N. P. Callahan

August 6, 1973

E. S. Miller

**PROPOSED RE-ESTABLISHMENT OF
CRIME RECORDS DIVISION**

At the Executives Conference, July 25, 1973, Mr. Kelley designated Messrs. Marshall, Jenkins, Gebhardt, Baker, Cleveland, and Miller to form a Committee to recommend a candidate to be the new Assistant Director of the proposed new division which will handle responsibilities formerly assigned to the Crime Records Division. Mr. Kelley indicated that he wanted the Committee's recommendations by 8/10/73 in order that he could make an announcement regarding the new division by 8/15/73. Mr. Kelley also wanted the Committee's recommendations concerning the name of the proposed division.

Subsequently, Mr. Walsh was added to the Committee with Director Kelley's concurrence.

On 8/1/73 the Committee met to discuss logical candidates to head up the new division. All of the Committee members present presented the names of the same three candidates for the position; that is, SAC Rex I. Shroder, San Diego Office; SAC John J. McDermott, Washington Field Office; and SAC Robert Russ Franck, Organized Crime Division-New York Office.

Considerable discussion followed regarding the qualifications of each man to fill this position and it was agreed that each could handle the position although because of personality differences, et cetera, each would approach the responsibilities in the position from a different standpoint, that is, each had his own strengths as compared with the other men. For example, it was acknowledged by all Committee members that SAC Franck would be the strongest candidate from the liaison standpoint but that the other two SACs were probably stronger from an administrative standpoint.

The consensus of the group was that these three men were so nearly comparable for this position that you could "cover them

ESM:lml (5)

- 1 - Mr. N. P. Callahan
- 1 - Personnel File of Rex I. Shroder
- 1 - Personnel File of John J. McDermott
- 1 - Personnel File of Robert Russ Franck

CONTINUED - OVER

PERMANENT BRIEFS OF REX I. SHRODER, JOHN J.
MC DERMOTT AND ROBERT RUSS FRANCK ATTACHED

ENCLOSURE

67-3 34-1114

Memorandum to Mr. N. P. Callahan
Re: PROPOSED RE-ESTABLISHMENT OF
CRIME RECORDS DIVISION

with a dime." However, the Committee rated them in the following order: (1) SAC Rex I. Shroder, (2) SAC John J. McDermott, and (3) SAC Robert Russ Franck.

As regards SAC Shroder, Committee members recalled that he was also a candidate for the position of Assistant Director of the Computer Systems Division; however, at that time recollections were that Mr. Shroder preferred for personal reasons to withhold his name from consideration due to the fact that he was in some way involved with the support or care of an aged mother. The recollections are not entirely clear on this issue but it is being mentioned since it may have some bearing on the Director's action in this appointment.

Due to the fact that the Committee feels that each candidate mentioned is qualified to handle the responsibilities of Assistant Director of the new division and since this new position is critically important to the Bureau, the Committee concluded that it would be well for Mr. Kelley to personally interview each of the candidates prior to making his selection. In this regard, members of the Committee are available to discuss in detail what the Committee felt were the special qualifications of each candidate for the job.

Name of Division

Various names for the new division were discussed including "Public Information and Research Division" and "Correspondence and Research Division," which had been previously suggested. It was pointed out that there is a prohibition against the use of the "Public Information" concept since this is already in use by the Department and since each Department can have only one such service.

It was also felt that the use of the word "Correspondence" in the title might convey to a critical public that we are devoting an entire division merely to handle correspondence matters although the Committee was sure that there would be some understanding that this problem represented quite a large volume of work in the Bureau. The Committee concluded that a more appropriate name for the new division would be "Research and Services Division" since all functions logically fell under these descriptive terms. The Committee, therefore, unanimously agreed that this would be an appropriate name.

CONTINUED - OVER

Memorandum to Mr. N. P. Callahan
Re: PROPOSED RE-ESTABLISHMENT OF
CRIME RECORDS DIVISION

RECOMMENDATIONS:

(1) That the Director consider personally interviewing SACs Shroder, McDermott, and Franck for the purpose of selecting the Assistant Director of the new division. Prior to this, he may wish to meet with members of the Committee to briefly discuss the qualifications of each of the men. Following Mr. Kelley's selection of the new Assistant Director, a press release will be prepared along the lines Mr. Kelley instructed in the Executives Conference.

(2) That the name of the new division be "Research and Services Division."

September 6, 1973

MEMORANDUM FOR MR. CALLAHAN
MR. WALSH
MR. HERINGTON

RE: SAC ROBERT RUSS FRANCK, New York
EXTERNAL AFFAIRS DIVISION -
ASSISTANT DIRECTOR

On September 6, 1973, I phoned SAC Franck in New York. I informed him I had decided to re-establish the old Crime Records Division as the External Affairs Division and informed him I would like to have him head this Division as Assistant Director and, for this purpose, wanted him to get in touch with Associate Director Callahan to make arrangements, hopefully, to report here in Washington on September 10, 1973, to make a study of the new Division's structure using previously supplied plans and to generally assist in setting up the Division.

SAC Franck indicated his appreciation and said he would do the best job of which he is capable.

Pursuant to this, when he reports, he should be given all available material on the new Division. A press release should be made after SAC Franck arrives announcing his designation and at the same time, an announcement of the creation of the new Division. I should be kept informed as to progress in this regard and before any structure is developed, I would like to talk with SAC Franck and give him the benefit of my ideas as to some particulars in which I am interested.

80004-1408

Very truly yours,

OCT 18 1973

151 C M Kelley

Clarence M. Kelley
Director

- Assoc. Dir. _____
- Asst. Dir.: _____
- Admin. _____
- Comp. Syst. _____
- Files & Com. _____
- Gen. Inv. _____
- Ident. _____
- Inspection _____
- Intell. _____
- Laboratory _____
- Plan. & Eval. _____
- Spec. Inv. _____
- Training _____
- Legal Coun. _____
- Tang. Serv. _____
- Off. _____
- Rm. _____
- Off. _____

1 - Personnel File of Robert Russ Franck

CMK:EDM (6)

SENT FROM D. O.	
TIME	7:20 Am
DATE	9-7-73
BY	edm

360

MAIL ROOM TELETYPE UNIT

PLAINTEXT

TELETYPE

FEDERAL BUREAU OF INVESTIGATION

NITEL

9/10/73

TO ALL SACS

FROM DIRECTOR FBI

EXTERNAL AFFAIRS DIVISION

CRIME RECORDS DIVISION

I HAVE ESTABLISHED A NEW DIVISION AT HEAD-
 QUARTERS NAMED EXTERNAL AFFAIRS DIVISION WHICH WILL
 BASICALLY HANDLE RESPONSIBILITIES ASSIGNED TO THE FORMER
 CRIME RECORDS DIVISION. FINAL ORGANIZATION HAS NOT BEEN
 COMPLETED BUT ROBERT RUSS FRANCK HAS BEEN DESIGNATED
 ASSISTANT DIRECTOR IN CHARGE OF THIS DIVISION. YOU WILL BE
 ADVISED OF ADDITIONAL DETAILS IN THE NEAR FUTURE. COPIES
 MAILED TO ALL LEGAL ATTACHES.

- 1 - Washington Field
- 1 - All Legal Attachés
- 1 - Foreign Liaison Desk (route through for review)
- 1 - Mr. Herington

JEH:asg
(26)

- Assoc. Dir.
- Asst. Dir.:
- Admin.
- Comp. Syst.
- Files & Com.
- Gen. Inv.
- Ident.
- Inspection
- Intell.
- Laboratory
- Plan. & Eval.
- Spec. Inv.
- Training
- Legal Coun.
- Comm. & Public Aff.
- Records Mgmt.
- Telephone Rm.
- Director Sec'y

BUREAU OF INVESTIGATION
 COMMUNICATIONS SECTION
 10:34 PM RXH
 SEP 13 1973

EX-104
 EM
 REC-40

TELETYPE

7 SEP

SEP 1

MAIL ROOM TELETYPE UNIT

66-1855-L

Handwritten signature

1022

UNITED STATES GOVERNMENT

Memorandum

MR. KELLEY

DATE: 9/11/73

FROM : N. P. CALLAHAN *nc*

SUBJECT: EXTERNAL AFFAIRS DIVISION
SUPERVISORY STRUCTURE
NO. ONE MAN POSITION

- Assoc. Dir. _____
- Asst. Dir.: _____
- Admin. _____
- Comp. Syst. _____
- Files & Com. _____
- Gen. Inv. _____
- Ident. _____
- Inspection _____
- Intell. _____
- Laboratory _____
- Plan. & Eval. _____
- Spec. Inv. _____
- Training _____
- Legal Coun. _____
- Cong. Serv. _____
- Corr. & Crm. _____
- Research _____
- Press Off. _____
- Telephone Rm. _____
- Director Sec'y _____

Z. Franck
of [unclear]

The purpose of this memorandum is to recommend that Inspector George T. Quinn, Inspection Division, be assigned to the newly established External Affairs Division as No. One Man to Assistant Director Robert Russ Franck.

Inspector Quinn is 45, married and has six children. He has a BA degree from Fordham College, New York, and served as an officer in the Army during 1950-1953 with extensive combat duty in Korea. Inspector Quinn entered on duty as a Special Agent 1/3/55, and served in the Chicago and Baltimore Offices, having been designated Relief Supervisor in the latter office 4/26/61. He was assigned to FBIHQ 8/19/63 as a supervisory Special Agent in the Special Productions Unit of the former Crime Records Division. He was designated Unit Chief of that Unit 5/2/67. Mr. Hoover designated Quinn as an Inspector 9/13/71 and he was promoted to GS-16 12/31/71. He has been assigned to the Inspection Division since 1/15/73.

Inspector Quinn's file is replete with commendations and awards based on his outstanding abilities and performance. He is uniquely qualified for the No. One Man position in the External Affairs Division based on his personality, experience, background, ability and merit. While assigned to the former Crime Records Division, Inspector Quinn demonstrated an ability to meet and favorably impress individuals in all walks of life. He has given numerous speeches and represented the Bureau most favorably. He served in an admirable manner while Chief of the Special Productions Unit, during which period he was responsible for and maintained liaison with management and theater dignitaries in connection with the national TV program "The FBI." He has developed an outstanding rapport in this field. He has presented prominent visitors to Director Hoover and participated in meetings of this nature. Since being assigned to the Inspection Staff, Inspector Quinn has participated in 10 field inspections. He has adjusted to these duties rapidly, displaying excellent insight. He has approached his responsibilities with diligence, enthusiasm and dedication. He has evidenced an intelligent approach

JJO:lae (2)

531706-185
7 SEP 21 1973
OVER

N. P. CALLAHAN TO MR. KELLEY
EXTERNAL AFFAIRS DIVISION

to problems, gets to the heart of the matter with dispatch, resolving same constructively. Assistant Director Jacobson rates him as outstanding in the performance of his inspection assignments. This matter has been discussed with Assistant Director Franck, who feels that this is an excellent selection to be his No. One Man.

RECOMMENDATION:

That Inspector George T. Quinn be designated No. One Man, External Affairs Division, to be effective immediately, at no change in grade or salary.

Approved - C. M. Kelley
9-17-73

PERMANENT BRIEF ATTACHED

Letter prep
9-17-73
wmb

AD Franck
See me pls -
cmk

Assistant Director

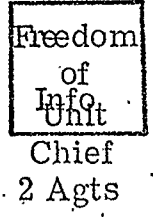
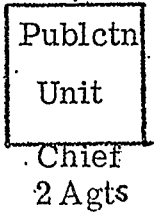
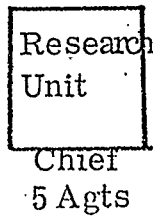
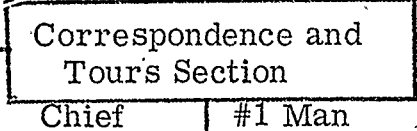
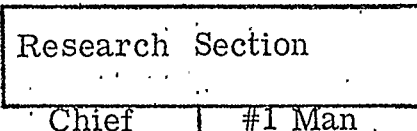
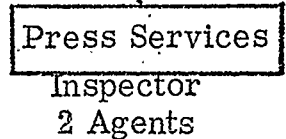
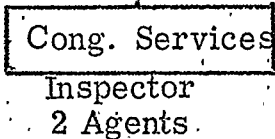
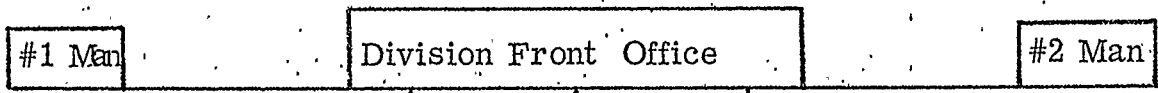

Research Section
Section Chief

#1 Man

Special Productions Unit

Radio
Television
Motion Pictures
Official Photographs
Recordings
National Academy
Publicity
Photographs in Director's
Office

Research Unit

Articles
Statements
Speeches
Research
Annual Report
Reference Library
Out-of-town
Telephone Directories
Parole, Probation, Juvenile
Delinquency and Pornographic
Research
Young American Medals

Fugitive Publicity Unit

Press Releases
Top Ten Publicity
"Fugitive" Articles in
Trade Journals
Public Law 670
Newspaper Clippings
Traveling Exhibits

Publications Unit

Law Enforcement Bulletin
Investigator
Revision of Publications
Interesting Case Program
Liaison with Government
Printing Office
Reprints
Posters
Booklets

Correspondence and Tours Section
Section Chief

#1. Man

Special
Correspondence Unit

Congressional Mail
Special Mail
Speech Programs
SAC Contacts
Autographed Photographs

Correspondence
Review Unit

Reads and reviews
Signature Mail

Nonspecial
Correspondence Unit

Routine Mail
Mailing List
Chronic Letter Writers
Form Mail
Editorial Records
Supplies
Inventory
Distribution of Law Enforcement
Bulletin, Uniform Crime Reports,
Investigator, and other publications

Freedom of Information
Act Unit

Review files for citizen
requests for information
under of Freedom of
Information Act

Tours
Unit

Tours

UNITED STATES GOVERNMENT

Memorandum

TO : The Director

DATE: 9/11/73

FROM : R.R. Franck *RFK*

SUBJECT: ORGANIZATION OF THE
EXTERNAL AFFAIRS DIVISION

Assoc. Dir.	_____
Asst. Dir.:	_____
Adm.	_____
Comp. Syst.	_____
Files & Com.	_____
Gen. Inv.	_____
Ident.	_____
Inspection	_____
Intell.	_____
Laboratory	_____
Plan. & Eval.	_____
Spec. Inv.	_____
Training	_____
Legal Coun.	_____
Cong. Serv.	_____
Corr. & Crm.	_____
Research	_____
Press Off.	_____
Telephone Rm.	_____
Director Sec'y	_____

Pitt
HE (RM 4/26/74)
Frank
...

Persuant to my discussion with you yesterday, my conversation with Mr. Callahan, and a conference with various Inspectors and supervisors of the new External Affairs Division, I suggest the attached organizational chart, depicting the setup of the Division's Front Office and the two Sections and Units, be approved. In addition to the discussions mentioned, my conclusion is based on a review of the material and memoranda previously prepared and submitted in connection with re-establishing the old Crime Records Division. These include the memorandum of 12/14/72 from Mr. Walters to Mr. Felt; a memorandum of 5/30/73 from Mr. Marshall to Mr. Felt; the memorandum of 9/5/73 from Mr. Miller to Mr. Callahan; and your memorandum of 9/6/73 to Mr. Callahan, Mr. Walsh and Mr. Herington.

In reaching this decision, careful consideration has been given to the responsibilities of the various sections and units, as well as that of the Front Office. In connection with the Front Office, one prime objective was to establish sufficient flexibility while at the same time maintaining direct control over all Division responsibilities. I believe the suggested organizational chart will accomplish this. William D. Ellingsworth, when he reports around 10/1/73, will be attached to Press Services in the Division Front Office. As in the past when the old Crime Records Division was in operation, all requests, telephonic and written, to meet with the Director will be handled by this Division and if received elsewhere should be referred here.

If this memorandum meets with your approval, my staff and I will begin organizing the Division immediately.

RECOMMENDATION:

That the suggested organizational chart for the new External Affairs Division as depicted in the attachment be approved.

Enclosure

- 1 - Each Assistant Director
- 1 - Mr. Callahan
- 1 - Mr. Herington
- 1 - Mr. Bowers

RRF:jo

SEE ADDENDUM OPE PAGE TWO

800-1-14/31
SEP 13 1973
...

ADDENDUM OFFICE OF PLANNING AND EVALUATION EES/imt 9/27/73

Representatives of OPE conferred with Mr. Franck prior to the formal drafting of the suggested organizational chart. OPE concurs with Mr. Franck's observations and recommendation as contained in this memorandum.

Handwritten initials

B/CA

Assistant Director

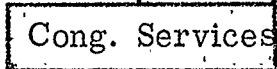
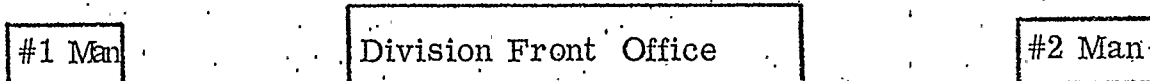

Inspector
2 Agents

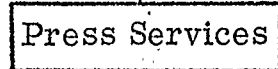

Inspector
2 Agents

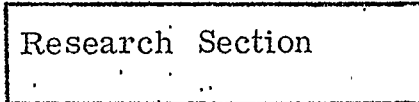

Chief #1 Man

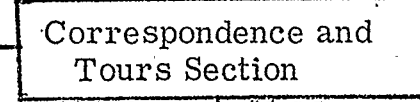

Chief #1 Man



Chief
2 Agts.

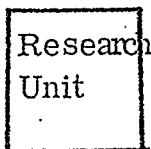

Chief
5 Agts



Chief
2 Agts



Chief
2 Agts



Chief
2 Agts



Chief



Chief
2 Agts



Chief



Chief

Research Section
Section Chief

#1 Man

Special Productions Unit

Radio
Television
Motion Pictures
Official Photographs
Recordings
National Academy
Publicity
Photographs in Director's
Office

Research Unit

Articles
Statements
Speeches
Research
Annual Report
Reference Library
Out-of-town
Telephone Directories
Parole, Probation, Juvenile
Delinquency and Pornographic
Research
Young American Medals

Fugitive Publicity Unit

Press Releases
Top Ten Publicity
"Fugitive" Articles in
Trade Journals
Public Law 670
Newspaper Clippings
Traveling Exhibits

Publications Unit

Law Enforcement Bulletin
Investigator
Revision of Publications
Interesting Case Program
Liaison with Government
Printing Office
Reprints
Posters
Booklets

Correspondence and Tours Section
Section Chief

#1 Man

Special
Correspondence Unit

Congressional Mail
Special Mail
Speech Programs
SAC Contacts
Autographed Photographs

Correspondence
Review Unit

Reads and reviews
Signature Mail

Nonspecial
Correspondence Unit

Routine Mail
Mailing List
Chronic Letter Writers
Form Mail
Editorial Records
Supplies
Inventory
Distribution of Law Enforcement
Bulletin, Uniform Crime Reports,
Investigator, and other publications

Freedom of Information
Act Unit

Review files for citizen
requests for information
under of Freedom of
Information Act

Tours
Unit

Tours

UNITED STATES GOVERNMENT

Memorandum

TO : MR. CALLAHAN

DATE: 10-2-73

FROM : R. R. FRANCK *RRF*

SUBJECT: SUPERVISORY STRUCTURE
NUMBER TWO MAN POSITION
EXTERNAL AFFAIRS DIVISION

- Assoc. Dir.
- Asst. Dir.
- Admin.
- Comp. Syst.
- Ident.
- Insp.
- Intell.
- Laboratory
- Plan. & Eval.
- Spec. Inv.
- Training
- Legal Coun.
- Telephone Rm.
- Director Sec'y

Callahan
RRF

The purpose of this memorandum is to recommend that ASAC James M. (Murphy) of the Tampa Office be assigned to the External Affairs Division as my #2 Man.

ASAC Murphy is 47 years old, married with three children and has a Bachelor of Arts degree from Tufts College, Medford, Massachusetts. He served in the U. S. Army during World War II and entered on duty as a Special Agent on 1-22-51. He served in the Cincinnati and Newark Offices, having been designated a relief supervisor in the latter office, prior to his assignment to FBI Headquarters on 5-15-60. During his assignment at FBI Headquarters, he served in the former Crime Records Division where he served as a Unit Chief from 8/66 until 6/70 when he was transferred to the Inspection Division as a Permanent Inspector's Aide. On 4-27-71 following his tour of duty on the Inspection Staff, he was reassigned to the Special Investigative Division where he served as Supervisor in Charge of the Unlawful Flight Unit in the Fugitive Section. He was designated ASAC of the Tampa Office on 1-3-72 and has been assigned to that office since that date.

439152-26

ASAC Murphy's file is replete with commendations and incentive awards based on his outstanding abilities and performance. It is noted that based on the high caliber of his performance as reflected in his last annual performance rating he was granted an incentive award. I feel he is uniquely qualified for the #2 Man position in the External Affairs Division based on his personality, experience, background and appearance, as well as his ability. While formerly assigned to FBI Headquarters and during his current assignment as ASAC in Tampa he has demonstrated an outstanding ability to meet and impress people in all walks of life, has given numerous speeches and has always represented the Bureau most favorably. Based on his present field experience he is capable of bringing a dimension to the operation of my division in terms of rapport with the field due to his first-hand knowledge of our needs regarding public relations and the ability to generate and implement ideas along these lines.

Enc.
RRF:crt
(2)

3/16

Memorandum to Mr. Callahan
Re: Supervisory Structure
External Affairs Division

RECOMMENDATION:

That ASAC James M. Murphy, Tampa Office, effective immediately, be transferred to FBI Headquarters and designated #2 Man in the External Affairs Division, at no change in grade or salary.

PHS

mm

os

aw

OK

PERMANENT BRIEF OF PERSONNEL FILE OF ASAC MURPHY
ATTACHED.

UNITED STATES GOVERNMENT

Memorandum

TO : MR. CALLAHAN

DATE: 10-4-73

FROM : R. R. FRANCK *RRF*

SUBJECT: SUPERVISORY STRUCTURE
RESEARCH SECTION CHIEF POSITION
EXTERNAL AFFAIRS DIVISION

- Asst. Dir.
- Asst. Dir.
- Admin.
- Comp. Syst.
- Ext. Affairs
- Files & Com.
- Gen. Inv.
- Ident.
- Inspection
- Intell.
- Laboratory
- Plan. & Eval.
- Spec. Inv.
- Training
- Legal Coun.
- Telephone Rm.
- Director Sec'y

R. R. Franck
10-10-73
WNB
4/3

The purpose of this memorandum is to recommend that SA Lawrence J. Heim, who acted as #1 Man in the Correspondence and Research Section while this section was attached to the Files and Communications Division, be designated Chief of the Research Section which has been established in the External Affairs Division.

Mr. Heim is 53 years of age, married, and has three children. He has a Bachelor of Arts degree in Journalism from Xavier University, Cincinnati, Ohio, and served as an officer in the U. S. Army from 1941 to 1946 being released from active duty with the rank of Captain. He entered on duty as a Special Agent on 3-3-47 and served in the El Paso and Seattle Offices. He was assigned to FBI Headquarters on 2-26-52 and has handled a wide variety of responsibilities in what was formerly the Crime Research Section of the Crime Records Division including supervision of the preparation of the Law Enforcement Bulletin and The Investigator and technical assistance in the preparation of various books by authors who wished to highlight the work of the FBI. Mr. Heim was designated #1 Man to the Chief of the Crime Research Section on 3-15-60 and served in that capacity until dissolution of the Crime Records Division last December. He has continued to operate as the #1 Man supervising the activities of this section which was incorporated into the Correspondence and Crime Research Section assigned first to the Training Division on 12-14-72, to the Files and Communications Division on 5-2-73 and to my division on 10-2-73. He is presently in Grade GS 15

Mr. Heim's file reflects numerous commendations and awards for his outstanding services over the years. Because of his background in the Research Section, his knowledge and his outstanding ability, he is fully qualified and is the logical choice for the position of Chief of the Research Section and I recommend him for this position.

RECOMMENDATION:

That SA Lawrence J. Heim be designated Chief of the Research Section of the External Affairs Division, effective immediately.

Letter prep 10-10-73 WNB
4/3
OTJ
WNB

Enc.

RRF:crt

DocId:32989630

Page 423

UNITED STATES GOVERNMENT

Memorandum

Assoc. Dir.	_____
Asst. Dir.:	_____
Adm. Serv.	_____
Ext. Affairs	_____
Files & Com.	_____
Gen. Inv.	_____
Ident.	_____
Inspection	_____
Intell.	_____
Laboratory	_____
Plan. & Eval.	_____
Spec. Inv.	_____
Training	_____
Legal Coun.	_____
Telephone Rm.	_____
Director Sec'y	_____

TO : MR. CALLAHAN

DATE: 10-10-73

FROM : R. R. FRANCK *RRF*

SUBJECT: REASSIGNMENT OF PERSONNEL
EXTERNAL AFFAIRS DIVISION

Handwritten notes and signatures:
 [Signature]
 [Signature]
 [Signature]
 [Signature]
 [Signature]
 [Signature]

By memorandum dated 9-11-73 the Director approved the organizational set-up of the External Affairs Division. The purpose of this memorandum is to set forth the reassignment of personnel in order that adjustments may be made in appropriate records. Attached is a list of the names of all employees in this Division with their positions, grades, and former division of assignment.

RECOMMENDATION:

That recipients of this memorandum make any adjustments necessary in records maintained and that the Administrative Division provide Personnel Records Section a short memorandum on each employee for inclusion in his personnel file.

* Position Classification Office
reasons will be submitted upon
furnishing of necessary info

Enclosure

*By the new
Division* 910
4/7/73

*memos prepared March
employee on 10-10-73*

GTQ:crt
(17)

- 1 - Mr. Marshall
- 1 - Mr. Walsh
- 1 - Mr. McMichael
- 1 - Mr. Gregory
- 1 - Movement Unit
- 1 - Mr. Row
- 1 - Miss Tibbetts
- 1 - Mrs. Crookston
- 1 - Miss Rochat
- 1 - Mrs. Stoll
- 1 - Mr. Rolander
- 1 - Mr. Jackson
- 1 - Mr. Cahill
- 1 - Mr. Cleveland
- 1 - Mrs. Metcalf
- 1 - Mr. Gebhardt

MPC

REC-10

[Handwritten signature]

EXTERNAL AFFAIRS DIVISION

(A) The following employees have been reassigned to the Front Office of the External Affairs Division:

<u>NAME</u>	<u>TITLE</u>	<u>FORMER DIVISION OF ASSIGNMENT</u>	<u>GRADE</u>
Robert Russ Franck	Assistant Director	New York Office	GS 17
George T. Quinn	Inspector - #1 Man	Inspection	GS 16
Jack E. Herington	Inspector	Director's Office	GS 16
T. J. Harrington, Jr.	Special Agent	Director's Office	GS 14
W. D. Ellingsworth	Administrative Assistant - News Media Officer	New Employee	GS 15
Carol R. Tschudy	Administrative Assistant	Administrative	GS 11
Joyce A. Osborne	Administrative Assistant	Director's Office	GS 11
Arlys S. Grage	Secretary (Stenography)	Director's Office	GS 9
Joan M. Broderick	Secretary (Stenography)	Director's Office	GS 6

(B) The following employees have been reassigned to the Congressional Services Unit:

David W. Bowers	Inspector	Director's Office	GS 17
C. Benjamin Fulton	Inspector	Director's Office	GS 15
Virginia C. Salpini	Clerk	Director's Office	GS 8
Elaine C. Haddock	Clerk	Director's Office	GS 6
Judy K. Largent	Clerk (Stenography)	Director's Office	GS 5
Karen J. Scott	Secretary (Stenography)	Director's Office	GS 6

(C) The following employees have been reassigned to the Research Section:

John H. Campbell	Special Agent	Files & Comm.	GS 15
Thomas B. Coll	Special Agent	Special Investigative	GS 14
Robert B. Davenport	Special Agent	Files & Comm.	GS 14
David L. Divan	Special Agent	Files & Comm.	GS 14
Robert C. Fay	Special Agent	Files & Comm.	GS 13
Edward H. Gooderham	Special Agent	Files & Comm.	GS 14
George William Gunn	Special Agent	Files & Comm.	GS 15
Lawrence J. Heim	Special Agent	Files & Comm.	GS 15
Dillard W. Howell II	Special Agent	Files & Comm.	GS 11
Anthony E. Schiappa	Special Agent	Files & Comm.	GS 14
Fern C. Stukenbroeker	Special Agent	Files & Comm.	GS 16

(C) (Continued)

<u>NAME</u>	<u>TITLE</u>	<u>FORMER DIVISION OF ASSIGNMENT</u>	<u>GRADE</u>
Joyce V. Anenson	Writer (Printed Media)	Files & Comm.	GS 12
U. Louise Gardner	Writer (Printed Media)	Files & Comm.	GS 12
Lois I. Reichert	Writer (Printed Media)	Files & Comm.	GS 12
Barbara H. Mohr	Editorial Assistant	Files & Comm.	GS 6
Claudia J. Rauch	Writer-Editor (Printed Media)	Files & Comm.	GS 6
Genell Whitson	Writer-Editor (Printed Media)	Files & Comm.	GS 8
Jane Hall Williams	Writer-Editor (Printed Media)	Files & Comm.	GS 8
Juris Bergs	Editor (Printed Media)	Files & Comm.	GS 5
Iona G. Swann	Supervisory Clerk- Stenographer	Files & Comm.	GS 6*
Debra Sue Sheffield	Secretary (Stenography)	Files & Comm.	GS 5
Diana K. Goselin	Secretary (Stenography)	Files & Comm.	GS 5
Donna J. Midkiff	Secretary (Stenography)	Files & Comm.	GS 5
V. Ann Gordon	Clerk-Stenographer	Files & Comm.	GS 5
Laurie Ann Demko	Clerk-Stenographer	Files & Comm.	GS 4
Judy Ann Martin	Clerk-Stenographer	Files & Comm.	GS 4
Linda R. Barrow	Clerk	Files & Comm.	GS 3
Sherry L. Gemberling	Clerk	Files & Comm.	GS 3
Sheryl A. Snee	Clerk	Files & Comm.	GS 3
Sherry A. Gerth	Clerk	Files & Comm.	GS 3
Marjorie Mae Holland	Clerk	Files & Comm.	GS 3
James R. Kramarsic	Clerk	Files & Comm.	GS 4
George J. Crane	Clerk	Files & Comm.	GS 4
Richard K. Macko	Clerk	Files & Comm.	GS 4
Rita H. Manning	Clerk	Files & Comm.	GS 9
Donna M. Gruntorad	Clerk	Files & Comm.	GS 4
Kathryn E. Sulewski	Clerk	Files & Comm.	GS 5
Adolph M. Kizas	Clerk	Files & Comm.	GS 3
Thomas H. Kunz	Clerk	Files & Comm.	GS 3
James E. Meinke	Clerk	Files & Comm.	GS 5
George J. Mink	Clerk	Files & Comm.	GS 3
Gail E. Rasch	Secretary (Stenography)	Special Investigative	GS 5
Larry D. Rodgers	Clerk	Special Investigative	GS 5

* In GS 6 Supervisory position with salary retention for two years in GS 9.

(D) The following employees have been reassigned to the Correspondence and Tours Section:

<u>NAME</u>	<u>TITLE</u>	<u>FORMER DIVISION OF ASSIGNMENT</u>	<u>GRADE</u>
Gordon E. Malmfeldt	Special Agent	Files & Comm.	GS 16
John C. Wagner	Special Agent	Files & Comm.	GS 15
Paul L. Andrews	Special Agent	Files & Comm.	GS 14
Robert C. Dean	Special Agent	Files & Comm.	GS 13
Ralph W. Engelmeier	Special Agent	Files & Comm.	GS 15
James C. Farrington	Special Agent	Director's Office	GS 15
Richard C. Dennis, Jr.	Special Agent	Office of Legal Counsel	GS 12
Allen H. McCreight	Special Agent	Files & Comm.	GS 13
Nancy Bronstein	Secretary (Stenography)	Files & Comm.	GS 7
Jerald W. Benningfield	Clerk	Files & Comm.	GS 4
Barbara J. Coyle	Clerk	Files & Comm.	GS 4
Rita M. Lindauer	Clerk	Files & Comm.	GS 3
Carolyn Ann Minnick	Clerk	Files & Comm.	GS 5
Kathryn L. Scheve	Clerk	Files & Comm.	GS 4
Mary Helen Ballard	Research Assistant	Files & Comm.	GS 10
Marjory L. Near	Research Assistant	Files & Comm.	GS 9
Anne West Tunney	Research Assistant	Files & Comm.	GS 10
Suzan J. Derk	Research Clerk	Files & Comm.	GS 5
Elizabeth S. Hudson	Research Clerk	Files & Comm.	GS 6
Joseph T. Iazzetta	Research Clerk	Files & Comm.	GS 5
Eliza Ann Parson	Research Clerk	Files & Comm.	GS 5
William W. Phipps, Jr.	Research Clerk	Files & Comm.	GS 5
Theresa R. Snyder	Research Clerk	Files & Comm.	GS 5
Vasilika V. Wallace	Research Clerk	Files & Comm.	GS 6
Linda L. Kloss	Stenographic Unit Supervisor	Files & Comm.	GS 7
Jean Kathryn McRae	Supervisory Clerk-Stenographer	Files & Comm.	GS 6
Celeste M. Cavalli	Clerk-Stenographer	Files & Comm.	GS 4
Beth Ann Finucan	Clerk-Stenographer	Files & Comm.	GS 4
Nancy Marie Iazzetta	Clerk-Stenographer	Files & Comm.	GS 5
Roxy Lee Monroe	Clerk-Stenographer	Files & Comm.	GS 4
Wilma Lee Ross	Clerk-Stenographer	Files & Comm.	GS 5
Melinda K. Shayuth	Clerk-Stenographer	Files & Comm.	GS 4
Valarie G. Wilson	Clerk-Stenographer	Files & Comm.	GS 4
Simone L. Robicheau	Clerk-Typist	Files & Comm.	GS 3
Barbara Lynn Elsea	Clerk-Typist	New Employee	GS 3

(D) (Continued)

<u>NAME</u>	<u>TITLE</u>	<u>FORMER DIVISION OF ASSIGNMENT</u>	<u>GRADE</u>
Nancy L. Adams	Clerk Dictating Machine Transcriber	Files & Comm.	GS 4
Roberta L. Zimmers	Clerk Dictating Machine Transcriber	Files & Comm.	GS 4
N. Cathryn Ross	Secretary (Stenography)	Files & Comm.	GS 4
Louise E. Beals	Correspondence Clerk	Files & Comm.	GS 7
Jean K. Bowen	Correspondence Clerk	Files & Comm.	GS 7
Ruth K. Klischer	Correspondence Clerk	Files & Comm.	GS 7
Carolyn A. Morse	Correspondence Clerk	Files & Comm.	GS 7
Kurt E. Kirschman	Clerk	Files & Comm.	GS 4
Karen Louise Mickens	Clerk	Files & Comm.	GS 5
Gracie A. Randhahn	Clerk	Files & Comm.	GS 5
Daniel C. Thomas	Clerk	Files & Comm.	GS 4
Steven E. Nixon	Clerk	Files & Comm.	GS 4
Jeffrey L. Summers	Publications and Supply Supervisor	Files & Comm.	GS 5
William Howe Dewan	Clerk	Files & Comm.	GS 3
John W. Cordon III	Clerk	Files & Comm.	GS 3
Bunny Sue Morris	Clerk	Files & Comm.	GS 3
Charles T. Bradley	Clerk	Files & Comm.	GS 3
Mildred M. Foster	Correspondence Unit Supervisor	Files & Comm.	GS 10
Katherine M. Mairs	Correspondence Unit Supervisor	Files & Comm.	GS 9
Blanche F. Anderson	Correspondence Clerk	Files & Comm.	GS 7
Mildred A. Babish	Correspondence Clerk	Files & Comm.	GS 7
Hazel R. Cross	Correspondence Clerk	Files & Comm.	GS 7
Nell Kennedy	Correspondence Clerk	Files & Comm.	GS 7
Jeannette E. Replogle	Correspondence Clerk	Files & Comm.	GS 7
Francis P. Frauson	Tour Leader (Supervisor)	Administrative	GS 10
David R. Whitling	Tour Leader (Supervisor)	Administrative	GS 7
Carmela F. Jackson	Clerk-Stenographer	Administrative	GS 5
Barbara Ann Pearson	Information Receptionist	Administrative	GS 4
Nancy J. Shield	Information Receptionist	Administrative	GS 4
Lee Ann Wolesslagle	Clerk-Stenographer	Files & Comm.	GS 4
Patricia R. Harding	Clerk	General Investigative	GS 6
Mary Sue Cole	Reviewer Analyst	Special Investigative	GS 9
Ester Boyd Daniello	Reviewer Analyst	General Investigative	GS 9
* Marion S. Ramey	Special Agent	Files & Comm.	GS 15
* Marie L. Strittmatter	Secretary (Stenography)	Files & Comm.	GS 5
** James A. Haisten	Publications and Supply Supervisor	Files & Comm.	GS 5

* Currently assigned to House Appropriations Committee

** On military leave since 6-9-72

UNITED STATES GOVERNMENT

Memorandum

- Assoc. Dir.
- Asst. Dir.:
- Adm.
- Comp. Syst.
- Ext. Affairs
- Files & Com.
- Ident.
- Inspection
- Intell.
- Laboratory
- Plan. & Eval.
- Spec. Inv.
- Training
- Legal Coun.
- Telephone Rm.
- Director Sec'y

TO : Mr. Franck *RFK*

DATE: 10-11-73

FROM : Mr. Neim *LJH*

SUBJECT: ORIENTATION PROGRAM
FOR NEWLY APPOINTED
SACS AND ASACS
EXTERNAL AFFAIRS DIVISION

9/22/73
2/2/74
REC-36

In 1958, the former Crime Records Division initiated an Orientation Program in the Division of one-day duration for all newly appointed SACS and ASACS. The purpose was to give the new officials indoctrination and instruction in various phases of public relations matters handled by the Division. There was a need for this program due to the fact that it is difficult to set out specifics about public relations matters and the handling thereof in instructional manuals, due to the variety of things that come up and changing policies and procedures. The one-day program covered various functions of the former Crime Records Division, including correspondence matters, speeches, radio and television programs, fugitive publicity, FBI publications, news release techniques.

REC-36 66-1925-1-1027

The program proved to be most mutually beneficial to the new Bureau officials and to the Division, and it continued with genuine interest and enthusiasm until the dissolution of the Crime Records Division in December, 1972. During the one-day program, the new SACS and ASACS visited supervisors in the Division, discussed particular phases of the operations, and received reference and research material concerning the Division's activities. Most frequently, the one-day program engendered questions which the new officials relayed to us subsequently. The biggest dividend from the program was the outstanding liaison which these new Bureau officials in their Field Offices maintained with the former Crime Records Division and their increased personal participation in public relations matters. The personal relation established by the new SACS and ASACS with the individual supervisors in the Division was an important factor in projecting the FBI image favorably to the public.

OCT 23 1973

RESEARCH SECTION

With the establishment of the External Affairs Division and with the important objective to restore the FBI to its rightful position with our citizens, we propose to reinstitute the highly successful one-day Orientation Program in the External Affairs Division for newly appointed SACS and ASACS.

OCT 23 1973

- Enclosure
- 1 - Mr. Callahan - Enclosure
 - 1 - Mr. Jenkins - Enclosure
 - 1 - Mr. Walsh - Enclosure

3/24

CONTINUED - OVER PERS. REC. UNIT

Mr. Heim to Mr. Franck Memo
RE: ORIENTATION PROGRAM

Attached is a sample schedule, similar to that previously used, for this instruction program. If approved, the scheduling and handling of this Orientation Program will be coordinated with the Administrative Division and the newly appointed Bureau officials, consistent with their departure dates and other commitments.

RECOMMENDATION:

That the one-day Orientation Program for newly appointed SACs and ASACs, formerly conducted by the Crime Records Division, be reestablished in the External Affairs Division.

9TQ

He

~~OS~~

SCHEDULE FOR ORIENTATION
PROGRAM FOR NEW SAC's and ASAC's
EXTERNAL AFFAIRS DIVISION

9:30 - 10:00	Mr. Coll Room 4258, Ext. 2545	Fugitive Publicity Unit - "Top Ten" Program; Fugitive Publicity outlets; exhibits; Young American Medals Program; PL 670; news clipping service.
10:10 - 10:45	Mr. Gunn Room 4266, Ext. 3645 Mr. Divan Room 4268, Ext. 3339	Special Productions Unit - Special Projects; feature articles; radio and TV matters, "The FBI" TV series; training films; official photographs.
10:55 - 11:25	Mr. Heim Room 4264, Ext. 3645	General Liaison; Field and External Affairs Division; reference data - speeches, articles.
11:35 - 12:10	Mr. Malmfeldt Room 4718, Ext. 2153	Correspondence and Tours Section - Correspondence matters; preparation of letters; Speech Program; Freedom of Information Act; SAC Contacts; Tours.
1:30 - 2:00	Mr. J. H. Campbell Room 622, OPO Ext. 2715	Publications Unit - Human Interest Items; Investi- gator; LEB: I.C. Memos; reprints for police instructors and for public.
2:30	Mr. Franck Mr. Quinn Room 5634, Ext. 3691	Meet. On-the-spot news release matters, public relations and policy points.

66-1855-2-1027